

1962-72

\$5.00

# Fairlane

1962-63 Meteor

1966-72 Ranchero

1966-70 Comet

1968-71 Montego

1966-71 Cyclone

1968-72 Torino



*Ranchero*

TORINO

For up to  
date pricing  
see Our Online  
Catalog



*Obsolete*  
& Classic Auto Parts, Inc.

8701 South I-35 Okla City, OK 73149

PH: 405-631-3933 or 1-800-654-3247

Fax: 405-634-6815

[www.ClassicAutoParts.com](http://www.ClassicAutoParts.com)



8701 South Interstate 35  
 Oklahoma City, Oklahoma 73149  
 (405) 631-3933  
 Publication # CB-E12-A75-2L1

**Manufacturers & Suppliers Of Quality Auto Parts**

**Specializing in Antique, Classic, Street Rod, and Obsolete Ford® Parts**

**Obsolete & Classic Auto Parts, Inc. Is Not Affiliated With The Ford Motor Company.**

We are extremely thankful for your business and want you to know that we appreciate the opportunity to help you in your restoration project. Call us anytime for all of your classic auto parts needs!

Parts listed in this catalog are all new unless stated otherwise such as rebuilt items. Some are genuine Ford® parts. Most of the parts we offer are exact reproductions of the original Ford® parts, made of the same and sometimes higher-grade material than the originals. Reproductions are as authentic as possible in every respect.

It is true that some of the parts we offer may cost a little more, but they fit like they should and they work right the first time. After 41 years in business, we have come across many cheaply made parts that simply do not work, do not fit correctly, or are prone to failure long before they should be. This costs everyone, you and us, more in the long run, both in time and in money. Therefore we only offer the best parts available from top name brands and quality manufacturer's. That way we can stand with confidence behind what we sell.

Some parts are limited in supply and are therefore offered subject to prior sale. Although every effort is made to keep the items listed in this catalog in stock, occasionally a part may be either temporarily out of stock, or become unavailable. Prices shown in this catalog were current at the time it was printed, and these prices supersede any previously published catalog or other material by Obsolete & Classic Auto Parts, Inc. Due to the nature of this business, manufacturer and supplier cost increases, and other market forces beyond our control, prices may fluctuate up or down and we reserve the right to change any listed price in this catalog or on our website without prior notification. Availability and/or substitution of any item listed in this catalog or on our website are also subject to change without notice.

We stock a tremendous inventory and try to provide you with the fastest and most efficient service possible. We offer Federal Express Next Day Air, Second Day Air, and Third Day select shipping, as well as standard ground shipping for your convenience. For standard ground shipping in the continental United States, please refer to the shipping chart found on the back of the order forms.

Air shipments, shipments made to areas outside the continental U.S., and international shipments, will be quoted at the time of invoicing. Items that cannot be shipped using standard shipping will be shipped motor freight and will incur additional charges.

We accept payment by personal check, cashier's check, money order and also American Express, Visa, MasterCard, and Discover credit and debit cards. We generally ship your order within 48 hours of when your payment clears. International orders must be paid by credit card or check or money order drawn on a U.S. bank in U.S. funds. We will ship your order as soon as such payment clears. We do not offer terms nor ship open account. If sending your order by mail, please use one of our handy order forms found in the back of this catalog. You may enclose a personal check or money order with your order or fill out your credit or debit card information on the order form. **DO NOT SEND CASH IN THE MAIL!**

Refunds require a proof of purchase as well as the original packaging and must be returned within 30 days of the date on the sales invoice. A 20% restocking fee may apply. We cannot refund items that have been installed, used, scratched, or show any sign of use. If an item to be returned needs to be shipped, you must get a Return Authorization Number (RA#) and write this number on the outside of the shipping container. We do not refund shipping charges. Return shipping must be prepaid. We will not accept C.O.D. return shipments. To get an RA# call us at (405) 631-3933. **NO REFUNDS ARE AVAILABLE ON BOOKS, CATALOGS, WOOD PRODUCTS, ELECTRICAL ITEMS, OR SPECIAL ORDER ITEMS!**

Orders requiring an exchange should be accompanied by the exchange. Due to the very limited availability of re-buildable cores, orders for rebuilt parts requiring a core exchange will not be processed until the core exchange has been received. Core shipping to us must be prepaid or they will not be accepted.

If you receive an order that has been damaged in shipping you must notify the carrier immediately. If you need assistance on a damaged shipment please call us at (405) 631-3933. **DO NOT RETURN DAMAGED ITEMS TO US!** If you receive an order that is wrong in any way, please call us within 72 hours of receipt. Claims for wrong orders will not be accepted after 72 hours.

**ABSOLUTELY NO REPRODUCTION OF ANY CONTENT IN ANY FORM MAY BE MADE FROM THIS CATALOG!!**



**Toll Free 1-800-654-3247**  
**Local 405-631-3933**  
**Fax 405-634-6815**

Online: [www.ClasticAutoParts.com](http://www.ClasticAutoParts.com)  
 E-mail Us At: [info@classicautoparts.com](mailto:info@classicautoparts.com)

**Store Hours**

Central Daylight Time

Monday - Friday 8:00 am to 5:30 pm  
 Saturday 8:00 am to Noon



# 1962-72 Fairlane

## A

4-speed tunnel hump . . . . .	71
AC brush and holder assembly . . .	51
AC compressor gasket . . . . .	139
AC condenser core . . . . .	139
AC registers . . . . .	139
Accelerator bellcrank assembly . . .	89
Accelerator pedal . . . . .	89-90
Accessory parts . . . . .	109
Acoustic-Shield kit . . . . .	161
Adhesives . . . . .	12
Air cleaner decals . . . . .	17-20
Air cleaner element . . . . .	87
Air cleaner grommet . . . . .	67
Air cleaner to carb gasket . . . . .	88
Air cleaner . . . . .	87
Air conditioner parts . . . . .	139-148
Air intake tube set . . . . .	87
Alternator pulley . . . . .	91
Alternator to regulator wiring . . .	107
Alternator . . . . .	91
Antenna base kit . . . . .	137
Antenna base pad . . . . .	137
Antenna kits . . . . .	137-138
Anti-squeak webbing . . . . .	112
Arm rest base . . . . .	184
Arm rest mounting clip . . . . .	184
Arm rest . . . . .	182-183

## B

Back of car parts . . . . .	190-194
Backup light lens gasket . . . . .	110
Ball caps . . . . .	15
Ball joint - upper and lower . . . . .	52
Battery cover . . . . .	92
Battery disconnect switch . . . . .	107
Battery hold down clamp . . . . .	92
Battery mat . . . . .	11
Battery tray . . . . .	93
Bed rail molding . . . . .	188
Blackwall tire . . . . .	40
Body insulation . . . . .	161
Bolt kits . . . . .	207-210
Books . . . . .	5-9
Brake drum - front and rear . . . . .	37
Brake fluid - silicone . . . . .	47
Brake hose - front . . . . .	46
Brake hose - rear . . . . .	49
Brake kits - front . . . . .	41-42
Brake kits - rear . . . . .	43
Brake master cylinder filler cap . . .	47
Brake parts . . . . .	41-51
Brake pedal pad . . . . .	50
Brake shoe spring . . . . .	45

Brake shoes - front . . . . .	44
Brake shoes - rear drum . . . . .	47
Brake wheel cylinder - rear . . . . .	48-49
Breakerless ignition system . . . . .	95
Bulk window channeling . . . . .	165-166
Bumper - front . . . . .	130
Bumper - rear . . . . .	131
Bumper bolt kits . . . . .	130
Bumper brackets . . . . .	130
Bumper stickers . . . . .	14

## C

Car covers . . . . .	211
Carb air cleaner hot air tube . . . . .	88
Carburetor adapter kit . . . . .	86
Carburetor linkage rod kit . . . . .	89
Carburetor rebuild kits . . . . .	87
Carburetor spacer . . . . .	86
Carburetor throttle end - front and rear . . . . .	90
Carburetor to manifold gasket . . . . .	86
Carpet jute backing . . . . .	161
Carpeting . . . . .	159
Castellated nuts . . . . .	209
CD changer . . . . .	135
Cigar lighter knob . . . . .	109
Clutch collar and throwout bearing set . . . . .	73
Clutch fork . . . . .	71-72
Clutch pedal pad . . . . .	50
Clutch pedal pad . . . . .	73
Clutch pedal to equalizer rod . . . . .	72
Clutch release lever bracket . . . . .	72
Clutch rod adapter . . . . .	72
Coat hook . . . . .	188
Console body . . . . .	154
Console padded lid . . . . .	154
Convertible back windows . . . . .	197
Convertible hydraulic cylinder . . . . .	195
Convertible hydraulic hose kit . . . . .	198
Convertible top weatherstrip . . . . .	196
Convertible tops . . . . .	197
Cowl kick panels . . . . .	149
Cowl side panel seal . . . . .	116
Cowl top vent seals . . . . .	149
Cruise control . . . . .	54

## D

Dash cap . . . . .	153
Dash emblem insert . . . . .	153
Dash knobs . . . . .	89
Dash to headlight wiring . . . . .	107
Decals . . . . .	18-35
Deck lid lock and key . . . . .	193
Defroster hose . . . . .	133

Differential bearing . . . . .	59
Differential clutch plate . . . . .	60
Disc brake rotor . . . . .	36
Distributor cap . . . . .	95
Distributor condenser . . . . .	96
Distributor rotor . . . . .	95
Distributor vacuum diaphragm . . . . .	96
Dome lamp lens . . . . .	104-105
Dome light assembly . . . . .	104
Dome light bezel . . . . .	105
Door and window parts . . . . .	164-184
Door bumpers . . . . .	173
Door handle cup . . . . .	172
Door handles . . . . .	171-172
Door jamb switches . . . . .	104
Door latch assembly . . . . .	169
Door latch repair kit . . . . .	169
Door lock knob grommet . . . . .	170
Door lock knobs . . . . .	169
Door panel metal clips . . . . .	164
Door scuff plates . . . . .	158
Door seal kits . . . . .	164
Driving pinion bearing cup . . . . .	59
Driving pinion oil seal . . . . .	60
Drum brake hardware kit . . . . .	45
Dummy spotlight . . . . .	109

## E, F

Electric fuel pump . . . . .	82
Electric window motor . . . . .	178
Electrical and wiring parts . . . . .	107-108
Emergency flasher wiring . . . . .	99
Emission decals . . . . .	26-27
Engine bolt kit . . . . .	208
Engine compartment decals . . . . .	20-24
Engine conversion installation brackets . . . . .	64
Engine dress-up kit . . . . .	63
Engine gasket set . . . . .	63
Engine oil dipstick . . . . .	66
Engine paint . . . . .	10
Exhaust air supply tubes . . . . .	86
Exhaust manifold gasket set . . . . .	84
Exhaust manifold . . . . .	83-84
Exterior and chassis decals . . . . .	34
Exterior screw set . . . . .	210
Fan blade . . . . .	79
Fan shrouds . . . . .	76-77
Fender - front . . . . .	111
Fender emblem - front . . . . .	112-116
Fender extension molding . . . . .	111
Fender extension seal . . . . .	113
Fender splash shield - front . . . . .	116
Fender to frame seal . . . . .	116
Fender washers . . . . .	210

# 1962-72 Fairlane

Fenders and hoods . . . . . 110-121  
 Filler cap - brake master  
   cylinder . . . . . 47  
 Firewall insulator kit . . . . . 149  
 Floor crossmember - front . . . . . 156  
 Floor mats . . . . . 160  
 Floor pan - front . . . . . 156  
 Floor pan - rear . . . . . 157  
 Floor shift boot . . . . . 71  
 Floor shift lever kit . . . . . 69  
 Fog lamps . . . . . 109  
 Frame parts . . . . . 61-62  
 Front brake drum . . . . . 37  
 Front brake hose . . . . . 46  
 Front brake kits . . . . . 41-42  
 Front brake shoes . . . . . 44  
 Front bumpers . . . . . 130  
 Front carb throttle end . . . . . 90  
 Front disc pads . . . . . 44  
 Front door glass run . . . . . 168  
 Front fender emblem . . . . . 112-113  
 Front fender splash shield . . . . . 116  
 Front fenders . . . . . 111  
 Front floor crossmember . . . . . 156  
 Front floor pan . . . . . 156  
 Front motor mounts . . . . . 63  
 Front spoiler . . . . . 131  
 Front valance panel . . . . . 127  
 Front wheel cylinder repair kit . . . . . 48  
 Front wheel cylinders . . . . . 45  
 Front wheel lip molding . . . . . 112  
 Fuel filter bracket . . . . . 81  
 Fuel filters . . . . . 81  
 Fuel lid emblem . . . . . 190  
 Fuel lines . . . . . 81  
 Fuel log assembly . . . . . 82  
 Fuel pump filter strainer . . . . . 83  
 Fuel pump . . . . . 83  
 Fuse panel . . . . . 95  
 Fuzzy dice . . . . . 15

## G

Gas caps . . . . . 80-81  
 Gas tank and fuel related parts 80-90  
 Gas tank door bumper . . . . . 80  
 Gas tank etch . . . . . 13  
 Gas tank etch . . . . . 79  
 Gas tank sealer kit . . . . . 79  
 Gas tank sealer . . . . . 13  
 Gas tank sealer . . . . . 79  
 Gas tank sending unit . . . . . 82  
 Gas tank straps . . . . . 81  
 Gas tanks . . . . . 80  
 Gasket - AC compressor . . . . . 139  
 Gasket - air cleaner to carb . . . . . 88

Gasket - backup light lens . . . . . 110  
 Gasket - carb to manifold . . . . . 86  
 Gasket - complete engine . . . . . 63  
 Gasket - exhaust manifold . . . . . 84  
 Gasket - oil pan . . . . . 67  
 Gasket - outside mirror mounting 130  
 Gasket - parking lens . . . . . 98  
 Gasket - tail lamp lens . . . . . 101  
 Gasket - tail light to body . . . . . 100  
 Gasket - transmission set . . . . . 69  
 Gasket - valve cover . . . . . 65  
 Gasket adhesive . . . . . 13  
 Gauge panels . . . . . 123  
 Gauges . . . . . 122-123  
 Generator - rebuilt . . . . . 91  
 Generator and battery parts . . . . . 91-94  
 Generator rebuild kit . . . . . 91  
 Generator splash shield . . . . . 91  
 Glass dots . . . . . 101  
 Glass setting tape . . . . . 167  
 Glove box liner . . . . . 154  
 Glove box spring . . . . . 154  
 Grill emblem . . . . . 77-78  
 Grill letters . . . . . 77  
 Grill vinyl trim kit . . . . . 77

## H

Harmonic balancer . . . . . 64  
 Head lamp covers . . . . . 97  
 Head lamp dimmer switches . . . . . 97  
 Head lamp doors . . . . . 97  
 Headers . . . . . 85  
 Headlight adjusting ring . . . . . 98  
 Headlight bulbs . . . . . 97  
 Headlight switch . . . . . 94  
 Headliners . . . . . 197  
 Heater blower wheel . . . . . 133  
 Heater core . . . . . 133  
 Heater defroster plenum . . . . . 132  
 Heater hose connector . . . . . 134  
 Heater motor . . . . . 133  
 Heater unit . . . . . 132  
 Heavy duty solenoids . . . . . 174  
 Hideaway audio solution . . . . . 135  
 High temp paint . . . . . 10  
 Hinge pin puller . . . . . 178  
 Hood bumper . . . . . 120  
 Hood emblem . . . . . 117  
 Hood hinge assembly . . . . . 120  
 Hood insulation . . . . . 119  
 Hood lift . . . . . 121  
 Hood lip molding clip . . . . . 121  
 Hood molding . . . . . 121  
 Hood pin brackets . . . . . 119  
 Hood pin kit . . . . . 119

Hood prop rod . . . . . 118  
 Hood safety latch . . . . . 121  
 Hood scoop emblem . . . . . 118  
 Hood scoop seal . . . . . 119  
 Hood scoop . . . . . 118  
 Hood to cowl weatherstrip . . . . . 120  
 Hoods . . . . . 117-118  
 Horn blowing switch assembly . . . . . 106  
 Horn blowing switch wire . . . . . 106  
 Horn button spring . . . . . 105  
 Horn relay and bracket . . . . . 106  
 Horn ring emblem . . . . . 57  
 Horn ring index plate . . . . . 105  
 Horn ring . . . . . 105  
 Horn switch assembly . . . . . 106  
 Hub cap center emblem . . . . . 37

## I, J, K, L

ID plates . . . . . 137  
 Ignition coil . . . . . 95  
 Ignition lock set . . . . . 170  
 Ignition parts . . . . . 95-96  
 Ignition switch bezel . . . . . 94  
 Ignition switch . . . . . 94  
 In-dash tachometers and  
   speedometers . . . . . 122-123  
 Inner fender apron . . . . . 111  
 Inside door handle . . . . . 171-172  
 Inside rearview mirror . . . . . 129  
 Instrument cluster voltage  
   regulator . . . . . 93  
 Insulation . . . . . 61  
 Interior console screw set . . . . . 209  
 Interior decals . . . . . 28-32  
 Interior door panels . . . . . 179-182  
 Interior screw kit . . . . . 209  
 Jack handle base . . . . . 125  
 Jack handle . . . . . 125  
 KBS sealer products . . . . . 13  
 Key blank . . . . . 193  
 Key blanks . . . . . 58  
 Keyless entry systems . . . . . 175-176  
 LED flasher . . . . . 99  
 License lamp lens . . . . . 103  
 License plate frames . . . . . 16  
 License plate light housing . . . . . 103  
 License plate mounting kit . . . . . 16  
 Light bulb pliers . . . . . 102  
 Light bulbs . . . . . 101-102  
 Lighting parts . . . . . 97-106  
 Lower ball joint . . . . . 52  
 Lower control arm . . . . . 52  
 Lower door glass bumper . . . . . 168  
 Lower shift bracket . . . . . 69  
 Lower steering idler arm . . . . . 54

# 1962-72 Fairlane

Lower vent window seal . . . . . 171

## M, N, O

Magnetic signs . . . . . 14  
Main body harness . . . . . 108  
Marker lamp bezel . . . . . 110  
Marker lamp . . . . . 109  
Master body bolt kit . . . . . 208  
Master cylinder repair kit . . . . . 44  
Master cylinder . . . . . 46-47  
Master engine bolt kit . . . . . 207  
Megaphone exhaust tips . . . . . 132  
Metal polish . . . . . 11  
Mirror bracket . . . . . 129  
Mirrors and bumpers . . . . . 128-131  
Miscellaneous decals . . . . . 35  
Miscellaneous interior parts. 149-161  
Molding clips . . . . . 165  
Motor mounts - front . . . . . 63  
Motor parts . . . . . 63-67  
Oil breather caps . . . . . 67  
Oil dipstick tubes . . . . . 67  
Oil filter element . . . . . 66  
Oil pan gasket . . . . . 67  
Oil pans . . . . . 66  
Oil pressure sending unit. . . . . 82  
Oil pumps . . . . . 65  
Outer tie rod end . . . . . 53  
Outside door handle . . . . . 171  
Outside mirror mounting gasket . 130  
Outside rearview mirror . . . . . 128  
Oval air cleaner . . . . . 88  
Overdrive control cable . . . . . 73  
Overflow tanks . . . . . 75  
Owner's manuals . . . . . 5

## P, Q

Package tray . . . . . 194  
Padded dash . . . . . 153  
Pan seat track support. . . . . 158  
Park and turn signal wire . . . . . 100  
Parking brake cable equalizer . . . . . 50  
Parking brake cable pulley . . . . . 51  
Parking brake cable . . . . . 51  
Parking lens gasket . . . . . 98  
Parking light lens . . . . . 98  
Parking signs . . . . . 14  
Pillar post molding . . . . . 150  
Pitman arm . . . . . 56  
Power door kit . . . . . 174  
Power door lock kits . . . . . 175  
Power steering pressure hose . . . . . 58  
Power steering pump gaskets . . . . . 56

Power steering pump pulley . . . . . 58  
Power steering return hose . . . . . 58  
Power trunk kit . . . . . 193  
Power window kit . . . . . 174, 177  
Power window switch . . . . . 108  
Power window switches . . . . . 174  
Quarter extension seals . . . . . 186  
Quarter window regulator  
handle . . . . . 189  
Quarter window roof pads . . . . . 198  
Quarter window vertical seal . . . . . 189

## R

Radiator caps . . . . . 75  
Radiator cooling filters . . . . . 75  
Radiator core support . . . . . 114  
Radiator hose set . . . . . 78  
Radiator mounting pad . . . . . 75  
Radiator parts . . . . . 74-79  
Radiator support hood bumper . . 120  
Radiator . . . . . 74  
Radio condenser . . . . . 137  
Radio knobs . . . . . 137  
Radios . . . . . 134  
Rear brake cable . . . . . 51  
Rear brake drum . . . . . 37  
Rear brake hose . . . . . 49  
Rear brake kits . . . . . 43  
Rear brake wheel cylinder . . . . . 48-49  
Rear bumpers . . . . . 131  
Rear carb throttle end . . . . . 90  
Rear compartment panel . . . . . 190  
Rear door seal kit . . . . . 184  
Rear drum brake shoes . . . . . 48  
Rear end and differential  
parts . . . . . 59-60  
Rear floor pan . . . . . 157  
Rear frame rails . . . . . 155  
Rear panel letters . . . . . 190  
Rear pillar covers . . . . . 171  
Rear quarter panel  
emblem . . . . . 185, 188  
Rear quarter panel seals . . . . . 186  
Rear quarter panel skins . . . . . 186  
Rear quarter parts . . . . . 185-189  
Rear quarter trim upholstery . . . . . 185  
Rear spring clamp . . . . . 62  
Rear spring relocation kit . . . . . 62  
Rear traction bar kit . . . . . 62  
Rear trim panels . . . . . 187  
Rear valance panel . . . . . 190  
Rear wheel cylinder repair kit . . . . . 46  
Rear wheel grease seal . . . . . 38  
Rear wheel lip molding . . . . . 112  
Rear wheel molding . . . . . 189

Rear window rubber . . . . . 191  
Rebuild kit - carb . . . . . 87  
Rebuild kit - generator . . . . . 91  
Redline tire . . . . . 39  
Repair buttons . . . . . 70  
Repair kit - door latch . . . . . 169  
Repair kit - front wheel cylinder . . 48  
Repair kit - master cylinder . . . . . 44  
Repair kit - rear wheel cylinder . . . 46  
Repair kit - turn signal cam . . . . . 99  
Restoration supplies . . . . . 10-17  
Ring gear and pinion set . . . . . 59  
Rocker arm and shaft kit . . . . . 64  
Rocker panel molding . . . . . 155  
Rocker panel . . . . . 155  
Roof of car parts . . . . . 195-198  
Roof pillar inserts . . . . . 196  
Roof rear sail panel . . . . . 194  
Roof side emblem . . . . . 195  
Roof side rail weatherstrip . . . . . 195  
Rust inhibitor . . . . . 12

## S

Scuff plate emblem . . . . . 158  
Seat belts . . . . . 200  
Seat foam set . . . . . 206  
Seat hinge covers . . . . . 199  
Seat latch handle kit . . . . . 199  
Seat parts . . . . . 199-206  
Seat track latch spring . . . . . 199  
Seat upholstery emblem . . . . . 206  
Seat upholstery . . . . . 201-205  
SecretAudio . . . . . 135  
Shift boot retainer . . . . . 70  
Shift knobs . . . . . 69-70  
Shift selector dial . . . . . 68  
Shifter lamp wire . . . . . 110  
Shock absorber . . . . . 132  
Shock tower export braces . . . . . 61  
Shock tower kit . . . . . 61  
Shocks, radios and heaters. 132-138  
Shop manuals . . . . . 5-6  
Shoulder strap boot . . . . . 199  
Side marker body pads . . . . . 110  
Silicone brake fluid . . . . . 47  
Spare wheel clamp . . . . . 39  
Spark plug wires . . . . . 95-96  
Spark plugs . . . . . 96  
Speakers . . . . . 137  
Specialty books . . . . . 7-9  
Speed nuts . . . . . 210  
Speedometer and wipers . . . . . 122-127  
Speedometer cable . . . . . 125  
Speedometer drive gear . . . . . 125  
Spin lock body bolts . . . . . 210

# 1962-72 Fairlane

Index

Spindle connecting rod . . . . .	53
Spring relocation kit - rear . . . . .	62
Stabilizer bar bushing . . . . .	62
Starter motor - rebuilt . . . . .	93
Starter solenoid . . . . .	94
Starter terminal posts . . . . .	93
Steel brake lines . . . . .	49
Steel hub cap . . . . .	37
Steel transmission lines . . . . .	68
Steel wheel accent set . . . . .	36
Steel wheel . . . . .	36
Steering column bushing . . . . .	55
Steering column to floor seal . . . . .	55
Steering gearbox - rebuilt . . . . .	55
Steering gearbox worm bearing and race . . . . .	56
Steering idler arm . . . . .	54
Steering parts . . . . .	52-58
Steering wheel collar . . . . .	55
Steering wheel emblem . . . . .	57
Steering wheel pad . . . . .	57
Steering wheel upper collar . . . . .	57
Steering wheel . . . . .	56
Step courtesy light . . . . .	104
Stone deflector . . . . .	131
Stop light switch . . . . .	103
Striker plate and shim . . . . .	170
Stripe kits . . . . .	162-163
Sub frame connectors . . . . .	61
Sun visor anchor pin . . . . .	152
Sun visor arm and bracket . . . . .	153
Sun visor arm clip . . . . .	152
Sun visors . . . . .	151-152
Synchronizer assembly . . . . .	69

## T, U, V

Tail lamp lens gasket . . . . .	101
Tail light bezel set . . . . .	103
Tail light lens . . . . .	100-101
Tail light to body gasket . . . . .	100
Tailgate cables . . . . .	192
Tailgate stripe kit . . . . .	192
Temperature sending bulb . . . . .	93

Thermostat . . . . .	78
Timing chain cover . . . . .	63
Tire valve stem covers . . . . .	40
Toe board . . . . .	156
Torque box . . . . .	155
Torque converter housing cover . . . . .	73
Transmission counter shaft . . . . .	68
Transmission dip stick . . . . .	68
Transmission dipstick tube . . . . .	70
Transmission gasket set . . . . .	69
Transmission mount . . . . .	64
Transmission parts . . . . .	68-73
Transmission tunnel cover . . . . .	71
Trunk decals . . . . .	33-34
Trunk emblem . . . . .	191-192
Trunk filler boards . . . . .	157
Trunk filler patch panel . . . . .	157
Trunk latch assembly . . . . .	192
Trunk lid seal kit . . . . .	193
Trunk lift . . . . .	121
Trunk lift . . . . .	193
Trunk mats . . . . .	194
T-shirts . . . . .	15
Tune up kit . . . . .	95
Turn signal cam repair kit . . . . .	99
Turn signal switch knob . . . . .	99
U-joint assembly . . . . .	60
Undercover speakers . . . . .	136
Universal door seal . . . . .	164
Universal molding clip . . . . .	187-188
Upper ball joint . . . . .	52
Upper control arm shaft kit . . . . .	52
Upper control arm . . . . .	53
USB/MP3 connector . . . . .	136
Valve cover decals . . . . .	25
Valve cover gaskets . . . . .	65
Valve covers . . . . .	65
Vent window handle set . . . . .	172
Vent window pivot stop . . . . .	173
Vent window rubber . . . . .	167
Vintage Air bulkhead plates . . . . .	146
Vintage Air compressors . . . . .	146
Vintage Air condenser . . . . .	147

Vintage Air controls . . . . .	145
Vintage Air cooling fans . . . . .	148
Vintage Air safety switches . . . . .	147
Vintage Air units . . . . .	140-144
Vinyl roof . . . . .	198
Voltage regulator . . . . .	92

## W, X, Y, Z

Water outlet . . . . .	79
Water pumps . . . . .	78
Wheel bearing grease . . . . .	11
Wheel cylinders - front . . . . .	45
Wheel grease seal - rear . . . . .	38
Wheel lip molding - front and rear . . . . .	112
Wheel parts . . . . .	36-40
Wheel trim ring . . . . .	38
Whitewall tire . . . . .	39
Windlace . . . . .	150
Window corner seals . . . . .	165
Window crank handle . . . . .	178
Window crank knob . . . . .	173
Window crank knob . . . . .	178
Window felt kits . . . . .	167-168
Window frame seal . . . . .	187
Window regulator scissors . . . . .	173
Window weld . . . . .	11
Windshield glass . . . . .	151
Windshield rubber . . . . .	151
Windshield washer bag . . . . .	127
Windshield washer cap . . . . .	127
Windshield washer hose tee . . . . .	127
Windshield washer pump . . . . .	127
Windshield wiper arm . . . . .	126
Windshield wiper knob . . . . .	126
Windshield wiper motor . . . . .	126
Wire connectors . . . . .	108
Wire loom . . . . .	107
Wire wheel center emblem . . . . .	38
Wire wheel spinner . . . . .	37
Wiring clip set . . . . .	108
Wiring diagram manuals . . . . .	6
Wiring terminal . . . . .	107



# 1962-72 Fairlane

## Owners Manuals

This is the small reference book that came standard in the glove box of every new car sold. These are a wealth of information and a must for every show car. Sometimes called the mechanic's handbook.



### Owner's Manuals

1966 Fairlane	
<b>BK-913 each</b> .....	<b>14.95</b>
1967 Fairlane	
<b>BK-911 each</b> .....	<b>14.95</b>
1968 Mercury®	
<b>BK-630-M each</b> .....	<b>9.95</b>
1969 Fairlane and Torino	
<b>BK-636 each</b> .....	<b>14.95</b>
1970 Torino/Fairlane/Ranchero	
<b>BK-640 each</b> .....	<b>14.95</b>
1971 Torino/Ranchero	
<b>BK-644 each</b> .....	<b>10.95</b>



### Illustrated Facts and Features

1969 Torino	
<b>BK-739 each</b> .....	<b>11.95</b>
1969 Cyclone and Montego	
<b>BK-917 each</b> .....	<b>11.95</b>
1970 Torino	
<b>BK-743 each</b> .....	<b>11.95</b>
1970 Cyclone and Montego	
<b>BK-919 each</b> .....	<b>11.95</b>
1971 Torino	
<b>BK-747 each</b> .....	<b>11.95</b>

## Shop Manuals

Shop manuals are probably the ultimate book when it comes to the original specifications and detailed information coming directly from the original Ford® parts department. Included are tons of information, specifications and instructions detailing every working aspect of your car. The large size of these books shows how much information and data is contained in every volume. Clearly a must when restoring cars! This is the book the original Ford® mechanics used to gather their information of the mechanics of the car. This is the book you need if you are doing your own repair work or restoration.

## Facts and Features Manuals

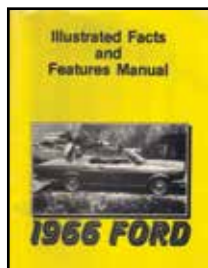
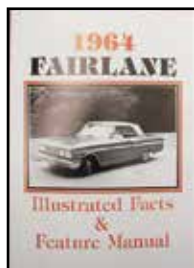

### Illustrated Facts and Features Manual

1964 Fairlane	
<b>BK-719 each</b> .....	<b>11.95</b>
1965 Fairlane	
<b>BK-723 each</b> .....	<b>11.95</b>
1966 Fairlane	
<b>BK-727 each</b> .....	<b>11.95</b>
1967 Fairlane	
<b>BK-731 each</b> .....	<b>11.95</b>
1967 Comet, Capri, Caliente and Cyclone	
<b>BK-915 each</b> .....	<b>11.95</b>
1968 Fairlane	
<b>BK-735 each</b> .....	<b>11.95</b>



### Shop Manuals

1962 Fairlane - 376 pages	
<b>BK-661 each</b> .....	<b>35.95</b>
The 1963 manual is the 1962 book with a 1963 supplement.	
1963 Fairlane - 479 pages	
<b>BK-665 set</b> .....	<b>47.95</b>
The 1964 manual is the 1962 book with both the 1963 and 64 supplements.	
1964 Fairlane - 652 pages	
<b>BK-669 set</b> .....	<b>71.95</b>



### Shop Manuals

1965 Fairlane and Comet - 685 pages	
<b>BK-672 each</b> .....	<b>38.95</b>
1965 Fairlane and Comet on CD	
<b>CD-1002 each</b> .....	<b>19.95</b>
1966 Fairlane and Comet - 782 pages	
<b>BK-676 each</b> .....	<b>38.95</b>
1966 Fairlane and Comet on CD	
<b>CD-1003 each</b> .....	<b>19.95</b>
1967 Fairlane and Comet - 902 pages	
<b>BK-680 each</b> .....	<b>39.95</b>
1967 Fairlane and Comet on CD	
<b>CD-1004 each</b> .....	<b>19.95</b>
1968 Fairlane and Comet - 974 pages	
<b>BK-684 each</b> .....	<b>64.95</b>
1968 Fairlane and Comet on CD	
<b>CD-1005 each</b> .....	<b>19.95</b>



### Shop Manuals

Five volume sets.	
1969 Fairlane and Montego - 1441 pages	
<b>BK-687-S set</b> .....	<b>68.95</b>
1969 Fairlane and Comet/Montego on CD	
<b>CD-1006 each</b> .....	<b>19.95</b>
1970 Fairlane and Montego - 1518 pages	
<b>BK-688-S set</b> .....	<b>89.95</b>
1970 Fairlane, Montego, and Torino on CD	
<b>CD-1007 each</b> .....	<b>19.95</b>
1971 Fairlane and Montego - 1493 pages	
<b>BK-689-S set</b> .....	<b>79.95</b>
1971 Fairlane, Torino and Montego on CD	
<b>CD-1008 each</b> .....	<b>19.95</b>
1972 Fairlane and Montego - 1549 pages	
<b>BK-690-S set</b> .....	<b>79.95</b>
1972 Fairlane, Torino and Montego on CD	
<b>CD-1009 each</b> .....	<b>19.95</b>

Online order is available 24/7!  
[www.ClassicAutoParts.com](http://www.ClassicAutoParts.com)

Books & Publications

# 1962-72 Fairlane

Books & Publications



## 1960-64 Ford® Parts Text

This is the original Ford® master text catalog. It has all the blown up diagrams, applications and original Ford® part numbers for every part from 1960-64, including the Fairlane. This book was used by every Ford® dealer on his parts counter as the main reference guide. Softbound, 8½ x 11", 1240 pages.

**BK-900 each..... 134.95**

1960-64 Parts Catalog on CD

**CD-42 each..... 26.95**

## 1960-64 Ford® Illustrations

Softbound, 8½ x 11", 926 pages.

**BK-901 each..... 134.95**

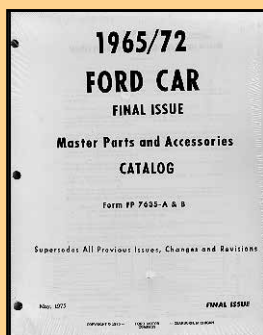

## 1965-72 Ford® Parts Text and Illustrations Catalogs

This is the combined text and illustration books in one lump sum. It includes every part number and every illustration on every passenger car from 1965-72, including the Fairlane. The set is approximately two feet thick. It is the set of books that is still used by every Ford® dealer as their reference material for 1965-72 Ford® cars. This requires 3-ring binders. Loose Leaf 8½ x 11", 5500 pages.

1965-72 Ford® Passenger

**BK-905-S set..... 352.95**

1965-72 Parts Catalog on CD

**CD-10 each..... 23.95**

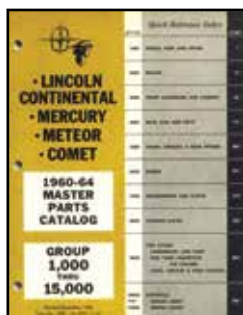

## Mercury® Master Parts Catalog

This is the original Mercury® master text catalog. It has all the blown up diagrams, applications and original Mercury® part numbers for every part from 1960-64, including the Comet. Softbound, 8½ x 11", 1194 pages

**BK-902 each..... 134.95**



## Illustrated Ford® Car Parts and Accessories Catalog

1963 Fairlane

**BK-504 each..... 76.95**

1964 Fairlane

**BK-508 each..... 79.95**



## 1969 Talladega Sales Folder

Softbound, 8½ x 11", 208 pages, 482 illustrations.

**BK-952 each..... 11.95**



## Wiring Diagram Manuals

1966 Fairlane

**BK-787 each..... 11.95**

1967 Fairlane

**BK-791 each..... 5.95**

1968 Fairlane

**BK-795 each..... 4.95**

1969 Fairlane

**BK-799 each..... 3.95**

1970 Torino

**BK-803 each..... 3.95**

1971 Torino

**BK-807 each..... 3.95**

## Obsolete & Classic Auto Parts, Inc.

8701 South I-35

Oklahoma City, OK 73149

## Summer Store Hours:

Monday - Friday

8 a.m. thru 6 p.m.

Saturday

8 a.m. thru 12 p.m.

## Winter Store Hours:

Monday - Friday

8 a.m. thru 5 p.m.

Saturday

8 a.m. thru 12 p.m.

(Central Standard Time)

**Don't forget to join our e-mail list. We send out e-mail specials, and you don't want to miss out!**



# 1962-72 Fairlane

## Non Factory Specialty Books

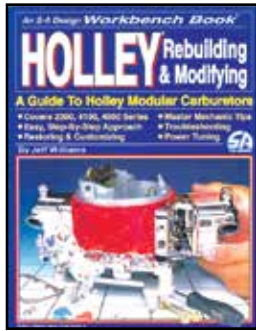

### Holley Carburetor Rebuilding and Modifying

Shows enthusiasts and home mechanics how to trouble shoot, disassemble, clean and inspect, reassemble and tune all popular Holley carburetors. Clear step-by-step illustrations and tips for performance, racing, economy, improved reliability, and even custom finishes for a show-winning appearance. Softbound, 8½ x 11", 128 pages, 300 illustrations.

**BK-597 each..... 21.95**

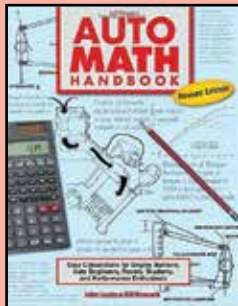

### Auto Math Handbook

by John Lawlor

At last here's an easy to read book that explains and illustrates the many automotive math equations in laymen's terms. Calculate stroke, bore, brake horsepower, torque, center of gravity, air capacity, final drive ratios, compression ratios, and much, much more. This book will enable you to put more horses under your hood with simple mathematical adjustments. Softbound,

8½ x 11", 144 pages, 205 illustrations.  
**BK-598 each..... 23.95**

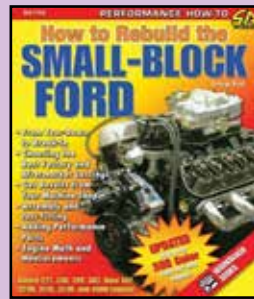

### How to Rebuild Your Small Block Ford®

How to find out what needs fixing. How to remove engine, tear down and inspect for wear, repair and recondition, assemble and install. Covers all years and models, 221, 260, 289, HP 289, 302, Boss 302 and 351W. Good solid information on these 1962 to 1978 Ford® engines. Softbound, 8½ x 11", 158 pages, 567 illustrations.

**BK-912 each..... 0.00**

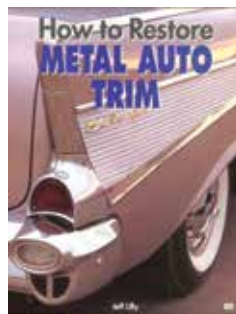

### How to Restore Metal Auto Trim

by Jeff Lilly

Whether you are restoring your vehicle for show or personal enjoyment, this book provides basic, step by step procedures for restoring and repairing metal trim pieces on your vintage car or truck. Contains information on all the necessary tools and materials essential for metal trim repair, including what you'll need, where to purchase items and how to use the tools and materials. Covers the repair of stainless steel and aluminum trim, including decorative strips, fenders, bumpers, hubcaps, wheel covers, and door and trunk handles. Softbound, 8½ x 10½", 96 pages, 150 illustrations.

**BK-374 each..... 26.95**



### How to Rebuild Big-Block Ford® Engines

by Charles Morris

All three engines are covered in full detail in this Workbench series rebuild volume. It includes step-by-step heavily illustrated instructions that walk you through the entire process of rebuilding your Ford® engine. If you want to breathe new life into your tired old Ford® engine, this is the book for you. 144 pages, 8½ x 11"

**BK-914 each..... 23.95**



### Hi-Per Parts

A reprint of the original Autolite/Ford® catalog of bolt-on performance parts for big blocks. Covers everything to modify your 390, 406, 427, 428, and Cobra-Jet for street and strip. Carbs, manifolds, valves, flywheels, cams and much, much more. Softbound, 8½ x 11, 38 pages, 68 illustrations

**BK-928 each..... 19.95**

**Friend us on Facebook and follow us on Twitter. You never know what you might be in for.**



*Check those prices on-line!  
See our website for current pricing.*

**1-800-654-3247**  
**Call Us for**  
**All-American**  
**Deals**

# 1962-72 Fairlane

## Non Factory Specialty Books

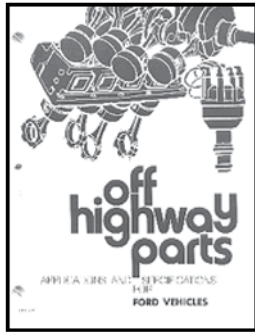

### Off Highway Parts

Reprint of the 1970's racing parts and modifications manual. Softbound. 8½ x 11", 108 pages, 168 illustrations. **BK-930 each..... 17.95**

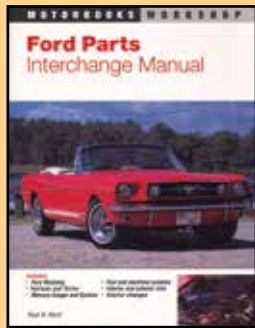

### Ford® Parts Interchange Manual

by Paul A. Herd  
The most complete and comprehensive manual ever assembled cataloguing all parts that can be interchanged among the many 1959-70 Mercury® and Ford® models. It is filled with more than 25,000 part numbers, specs, dates and technical details on engine blocks, heads, valves, crankshafts, camshafts, pistons and more. Photos, diagrams, charts and reference tables list all the equipment available and their interchange uses, plus advice on which parts work best for special applications. Tips on component selections and a handy interchange reference. Softbound, 8½ x 11", 224 pages, 300 illustrations. **BK-931 each..... 0.00**

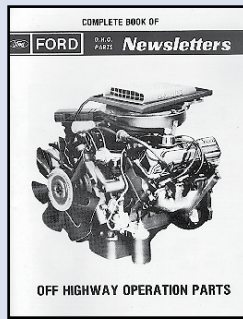

### Off Highway Operations

Collections of eleven off-highway operations newsletters from form. Numerous illustrations. Softbound, 8½ x 11", pages, illustrations. **BK-936 each..... 13.95**

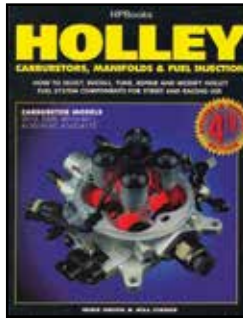

### Holley Carburetors and Manifolds

Tips on choosing the right model for your motor, plus troubleshooting, repair, rebuilding and more. Special section on alcohol fuels. Softbound, 8½ x 11", 208 pages, 482 illustrations. **Price Reduced! BK-937 each..... 26.95**

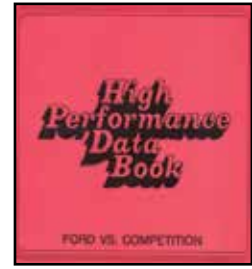

### 1970 High Performance Handbook

Salesman's training and information book. Softbound, 8½ x 11", pages, illustrations. **BK-960 each..... 13.95**

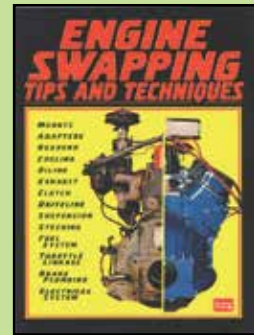

### Engine Swapping Tips and Techniques

From the experts at Hot Rod Magazine comes this guide to engine swapping. Covers all critical areas to completing a professional quality swap - How to choose an engine, what to look for, engine bay modifications, engine mounts, drive line considerations and more. Softbound, 8" x 10½", 164 pages, 340 ill. **BK-962 each..... 19.95**

**We accept these MAJOR credit cards.**

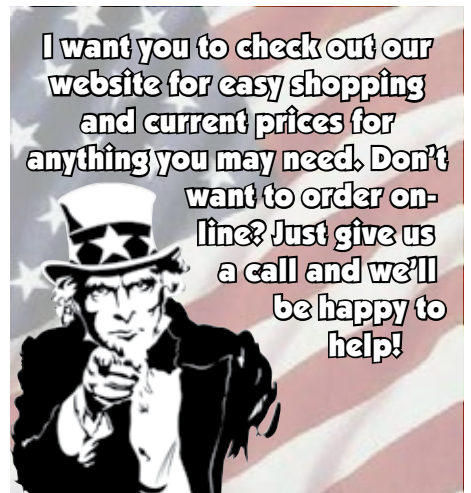

# 1962-72 Fairlane

## Non Factory Specialty Books

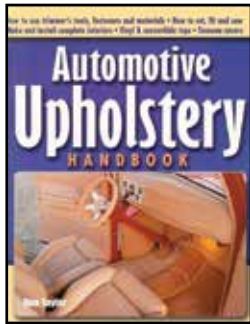

### Automotive Upholstery Handbook

by Don Taylor

In this revised edition, learn to make and install complete interiors in your Ford®. The author teaches you how to sew like an expert and avoid costly mistakes. Learn to recover and build bench seats, make headliners and install carpets. Material are described with specific recommendations for vinyl, cloth, velvet, leather, panel board, etc. 2nd Edition, softbound, 8½" x 11", 232 pages, 550+ illustrations.

**BK-984 each . . . . . 20.95**

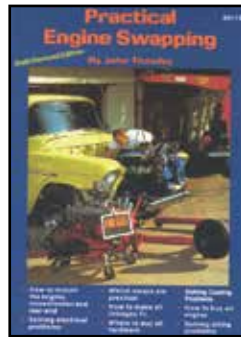

### Practical Engine Swapping

Subjects covered include how to mount engine, transmission and rear end, solving electrical problems, which swaps are practical, how to make all linkages fit, where to buy all hardware, hot to build adapters, how to buy and engine and solving oil issues. Softbound, 7" x 10", 124 pages, 257 illustrations.

**BK-900-26 each . . . . . 134.95**

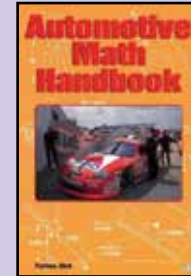

### Auto Math Handbook

by Forbes Aird

This book explains and illustrates the wide variety of today's Auto Math Equations in clear terms for every do-it-yourselfer. Calculations explained include - gross vehicle weights, bore and stroke, gear ratios, alignments, caster, camber, toe in and out, fastener strengths, air flows, carbs, centrifugal force, fuel consumption, modulus of elasticity, tire pressure, oil viscosity, cam timing, brake horsepower and much more. Ideal for drivers, students or engineers. Softbound, 6" x 9", 144 pages, 65 illustrations.

**BK-900-30 each . . . . . 134.95**



### N.A.D.A. Classic and Collectible Appraisal Guide

This convenient guide contains 52 years of low, average and high retail values for all kinds of classic and special interest cars and trucks. You can easily find reliable values for classic collectible, special interest cars and trucks for model years 1946-78 and exotic cars manufactured from 1946-98. Additionally this book contains an optional equipment section, manufacturer retail prices and vehicle weight information. Softbound, 4¾ x 8", 620 pages.

**BK-985 each . . . . . 62.95**

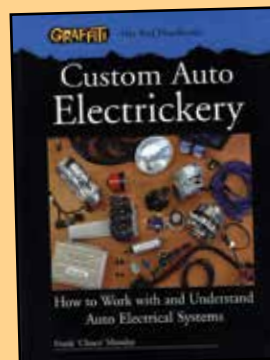

### Custom Auto Electronics and Auto Electrical Reference Manual

by Frank Munday

Clearly labeled and cross references chapters guide you thru the basics of auto electronics, the charging system, starting and ignition systems. A special chapter is devoted to rewiring your vehicle using either a custom made harness or a popular aftermarket harness. Contains an extensive chapter on troubleshooting modern electronic systems. Softbound, 8½" x 11", 262 pages, 140 illustrations.

**BK-900-29 each . . . . . 134.95**



**Our standard ground service is shipped by FedEx. If you desire another carrier, let us know when you place your order, and we'll get you the details.**



# 1962-72 Fairlane



## Hi Temp Exhaust and Manifold Paint

These paints are rated to withstand temperatures up to 2000 degrees F. Brush or spray these on to new, clean, or sandblasted manifold and exhaust areas and they will restore the look to new. Easy to use, withstands virtually all weather conditions, dries fast and yields amazing results.

- Space Age Bright Aluminum** Price Reduced!  
**M-96-BAP each** ..... 38.95  
**Space Age Black** Price Reduced!  
**M-96-BP each** ..... 38.95



## Hi Temp Exhaust and Manifold Paint

Brush or spray these on to new, clean, or sandblasted manifold and exhaust areas and they will restore the look to new. Easy to use, withstands virtually all weather conditions, dries fast and yields amazing results.

- Cast Iron Grey** - up to 1800 degree Price Reduced!  
**M-96-CIGP each** ..... 38.95  
**Stainless Steel** - up to 1600 degree  
**M-96-BP each** ..... 38.95



## Super Black Chassis Paint

The finest black chassis paint. Not glossy, not dull, but a very high quality semi-gloss paint that is the most resistant to chipping, cracking, peeling and salt. An excellent paint for the engine compartment of your car as well. Out lasts and out performs any similar product.

- Price Reduced!  
**M-96-CPQ quart** ..... 39.95



## Aerosol Engine Paint

- Antique Ford® Blue** - 16 oz.  
**PT-95-AEB each** ..... 5.95  
**Ford® Black** - 11 oz.  
**PT-95-FBK each** ..... 9.95  
**Ford® Orange** - called "Chevy Orange" in the Ford® parts book - 11 oz.  
**PT-95-FCO each** ..... 5.95  
**Ford® Blue** - a medium blue - 11 oz.  
**PT-95-FDBL each** ..... 9.95  
**Light Green** - 11 oz.  
**PT-95-FGR each** ..... 9.95  
**Ford® Red** - 16 oz.  
**PT-95-FRD each** ..... 5.95



## Hi Temp Engine Enamel

Highest quality engine enamel available on the market today. Extremely high solid content, heat resistant to 700 degree F. Most show winning cars today use Bill Hirsch Engine Enamel. High gloss, easy to use. Can be brushed or sprayed.

- Black**  
**PT-95-QBL quart** ..... 44.95  
**Ford® Bronze**  
**PT-95-QBR quart** ..... 44.95  
**Ford® Blue**  
**PT-95-QFB quart** ..... 44.95  
**Medium Blue**  
**PT-95-QMB quart** ..... 44.95



## High Heat Manifold Paint

- Aluminum** - 11 oz.  
**PT-95-HTA** ..... 5.95  
**Black** - 11 oz.  
**PT-95-HTB** ..... 4.95



## Cast Aluminum Spray Paint

Gives aluminum a new look - 11 oz. spray can  
**PT-95-CA each** ..... 12.95

## Chrome Spray Paint

Gives chrome a new look - 11 oz. spray can  
**PT-95-CHR each** ..... 3.95

## Cast Iron Gray Paint

Gives cast iron a new look - 11 oz. spray can  
**PT-95-CIG each** ..... 12.95

## Black Undercoating Spray

20 oz. spray can  
**PT-95-UNC each** ..... 5.95

An American Classic!



# 1962-72 Fairlane



## The Absorber

This is the best chamois you'll ever have. Ideal to keep inside the glove box for those all too often spills and puddles. It comes complete with its own storage container easy enough to store in your glove box, tool box etc. Guaranteed not to rot, mold or mildew.

Small - 13" x 17"

**M-96-ABA each ..... 7.95**

Large - 27" x 17"

**M-96-ABB each ..... 9.95**



## Battery Mat

Battery Mat is a chemically treated felt like pad which is placed in the battery box under the battery. The mat is treated with a chemical base which will neutralize any acid spills coming from the battery before it can damage the equipment. Easy installation, cut to fit. 8" x 12"

**M-96-BMAT each ..... 6.95**



**New!**

## Metal Polish

Mr. Buffer contains no acids, ammonia or citrus which can harm your metals over time. Instead, Mr. Buffer polishes all metals effortlessly, leaving a protective coat that prevents rust, tarnish and other forms of oxidation. 12 ounce bottle.

**M-99-MB each ..... 14.95**



## Black Window-Weld

Urethane fits 1/10 gallon cartridge gun. This one part adhesive sealant is designed specifically to use in the replacement of bonded windshields and back glasses. It features excellent handling, performance and curing properties that make it ideal for the reinstallation of automotive glass. Requires no primer.

**M-96-BWW each ..... 38.95**



## Plastic and Emblem Adhesive

Excellent clear adhesive for plastic repair and emblem application. Use for plastic or metal emblem adhesive, interior rigid plastic, tail light lens repair, vinyl side mouldings or upholstery. 5 oz.

**M-96-EA each ..... 11.95**



## Wheel Bearing Grease

One pound can

**M-96-WBG each ..... 11.95**



## White Lithium Grease

Ideal for window regulators, rollers, door, latches, hood hinges, trunk hinges and door hinges. 16 oz.

**M-96-WLG each ..... 2.95**



## Fuel Preservative and Stabilizer

**Price Reduced!**

Prevents gum, varnish formation and corrosion in fuel tanks and fuel systems. Absolutely a must for cars, boats, planes or any other equipment when the fuel sits idle in a tank for 30 days or more. One ounce of this product will keep 3 gallons of fuel fresh for at least 3 years. Contains no alcohol that attacks some metals. Will not attack rubber parts of diaphragms as most other do. Unlimited shelf life. Safe for all 2 or 4 cycle engines. One quart will protect 100 gallons of fuel for over 3 years. Retards decaying of ethanol fuels.

**M-96-FPS quart ..... 24.95**



## The Original California Car Duster

Specially treated cotton strands lift dust off the most delicate of lacquer jobs. Guaranteed not to scratch paint with its unique circular sweeping motions. You can maintain that "just washed look" with ease. A must for every show car! Comes complete with its own vinyl storage bag.

**M-96-MD each ..... 28.95**

Check out our Swap Meet Schedule to see when we will be in your area. Maybe even save some on shipping. Call one of the guys for more information!

# 1962-72 Fairlane

Restoration Supplies



### Nylon Axle Straps

This is a must for anyone who hauls or does any transporting of vehicles. These eliminate the scratching of paint when hauling or trailering your car or pickup. This is a very small investment for safety and security. Complete with mid-hooks.

**M-96-NAS each ..... 14.95**



### Poly Ratchet Tie Downs

Matches the M-96-NAS axle straps. Comes with 6 foot straps that hold 5,000 lbs. Dead weight. This is a must to ensure safety and security to your project when hauling or trailering from one place to another. Comes with a 1-year warranty against any ratchet defects.

**M-96-NRTD each ..... 37.95**



### Rust Inhibitor

Strip now, paint later. Sandblast or strip all of your parts now without having to worry about them rusting before you paint them. After stripping or sandblasting, spray a light coat of this product on your parts they will be safeguarded against rusting. Can be sprayed or dipped. Easily washes off with water. Non flammable, non toxic and biodegradable.

**M-96-RIG gallon ..... 33.95**



### 3M Super Trim Adhesive

Fast acting, high strength, aerosol contact adhesive designed for two surface application. This is resistant to heat and plastic oils and is excellent for attaching vinyl tops, headliners, vinyl insulation, foam padding and rubber parts to metal and other surfaces. Bonds can be made within minutes of application or as long as one hour later. 18 oz. can.

**M-96-STA each ..... 0.00**



Price Reduced!

### 3M General Trim Adhesive

Rapid drying, high strength, light colored adhesive. Designed for bonding most types of material used in automotive trim operation except unsupported vinyl. Excellent for fabrics, upholstery, foam, jute pads, carpets, re-bonding vinyl top sections, etc. Has adjustable spray pattern, high initial strength and does not require shaking or agitation before using. Provides excellent heat resistance. 24 oz.

**M-96-TA each ..... 9.95**



### 3M Spray Trim Adhesive

Transparent, extremely gas drying adhesive with long tack for attaching upholstery cloth, floor mats, carpeting, kick pads and silencer pads to painted or bare metal, wood, kb board or other materials. 24 oz. Can

**M-96-EXTA each ..... 9.95**



### Woodgrain and Striper Remover

Specially designed for removing vinyl tripes from acrylic enamel surfaces. Jelly like consistency keeps remover in place on vertical surfaces to promote fast action when sprayed from the aerosol. Saves on repair and repaint. 24 oz. can

**M-96-WSR each ..... 22.95**



### 40-Below Cooling Fluid

This is a product demanded by our local customers. It is an additive that you put into your radiator. It completely stops overheating. Thru a patented chemical process it helps to reduce your water temperature 20-40°. Cools extremely well when your radiator gets partially clogged or your car is in a prolonged tight draft. A/C blows colder and works more efficiently due to cooler system temperature. The heater blows hotter which warms passengers sooner and keeps water temperature from rising excessively while vehicle is towing, climbing, sitting in traffic or running with restricted air flow. It is ideal for those flat heads that run a little on the warm side. Great for racing, towing, street rods, RV's etc. Note: This is not an antifreeze although it works with or without antifreeze in the system (30 oz. Can)

**M-96-40B each ..... 33.95**



### Semi-Chrome Polish Polishing Paste

1.76 oz.

**M-99-SP each ..... 13.95**

# 1962-72 Fairlane

Restoration Supplies



### Hirsch Gas Tank Sealer

Alcohol resistant gas tank sloshing compound. Impervious to all fuel types. This will help you restore and repair your tank. It will seal pinhole leaks and prevent rusting. Sold per quart  
(Stock # A09-15005-005)

**OEM # A-9001-ALR each . . . . . 38.95**

### Hirsch Gas Tank Etch

This is a prep for your gas tank before introducing the sealer. It will remove light buildup of rust inside your tank and leaves a grey phosphate coating. 1 pint will do about a 30 gallon tank.  
(Stock # A09-15005-010)

**OEM # A-9001-GTE each . . . . . 15.95**



### KBS Fuel Tank Sealer Kit

The KBS Fuel Tank Sealer Kit contains everything you need to seal a tank of up to 25 gallons. Contains 2 qts. AquaKlean, 1 qt. RustBlast, 1 qt. Gold Standard tank sealer, 1 pair Nitrile gloves and a stir stick. These KBS prep products are formulated with a unique Oxygen-Block Technology which reduces the occurrence of flash rust by over 80% and extends rust-free storage times by leaving a temporary protective coating in addition to a zinc phosphate film.

**KBS-9000 kit . . . . . 79.95**



### Super Gasket Adhesive

Gelled, non-stringing, adhesive for bonding paper, cork or rubber. Resistant to gas, oil, etc. 5 oz. tube.

**Yellow** - (Stock # P19-30170-005)

**OEM # COAZ-19552-A each . . . . . 9.95**

**Black** - (Stock # P19-30170)

**OEM # 8A-19552-A each . . . . . 14.95**



Gloss



Satin

### KBS Trunk and Floor Pan Kit

You can maintain the integrity of the structure with no ugly welded seams. Our easy step-by-step instructions make it simple to restore floor pans, trunk pans, etc. You'll receive a full gallon of each of the prep products you need to do the job the RIGHT way! Complete with a gallon of AquaKlean and RustBlast, quart of RustSeal, 1 lb. NuMetal Epoxy Putty, 1 sq yard BackBone reinforcing mesh, 18 oz., #1 thinner, 1 paint spout, 5 pair of Nitrile gloves, 1 mask, 2 brushes, stir stick and complete detailed instructions.

**Gloss Black**  
**KBS-59001 kit . . . . . 155.95**

**Satin Black**  
**KBS-59002 kit . . . . . 155.95**



Classic Auto Parts has been serving your car and truck needs since 1974!

We appreciate our customers!

**1-800-654-3247**  
**Call Us for**  
**All-American**  
*Deals*

**We accept these MAJOR credit cards.**



# 1962-72 Fairlane

Restoration Supplies



## Genuine Ford® Parts Oval Magnet

White on Blue - 4" Oval  
MM-200-203 each..... 2.95



## Genuine Ford® Mechanic Works Here Magnet

White on Blue - 4" Wide  
MM-200-213 each..... 3.95



MM-3



MM-2



MM-5

## 3" Wide Magnetic Signs

MM-2 each ..... 9.95  
MM-3 each ..... 9.95  
MM-5 each ..... 9.95

## Bumper Stickers

10" x 3" sold each



BS-64 ..... 3.95



BS-67 ..... 3.95



BS-69 ..... 3.95



BS-65 ..... 3.95

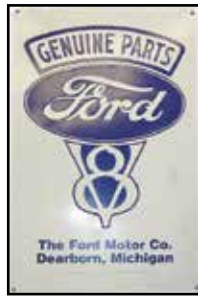

## Genuine Parts Ford® V-8 Tin

11" x 7"  
S-99-GFP each ..... 24.95

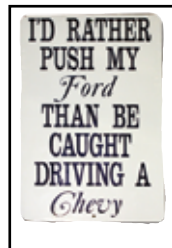

## 'I'd Rather Push My Ford® Than Be Caught Driving A Chevy'

Aluminum sign-12" x 18"  
PS-99-PMF each ..... 16.95



## Aluminum Parking Only Signs

12" x 18" One sided - pre-drilled for easy hanging. Great gift items!  
Ford® ..... #PS-99-FPO  
Pro Street..... #PS-99-PSPO  
Race Car..... #PS-99-RCO  
Don't Think of Parking ... #PS-99-DET  
Men and Boys ..... #PS-99-MBPT  
Big Kids Toy ..... #PS-99-BKTPO

ANY ABOVE SIGN \$16.95 each



## Genuine Ford® Parts Sign

Tin, blue and white, 12" oval  
S-99-GFP each ..... 24.95

## Obsolete & Classic Auto Parts, Inc.

8701 South I-35  
Oklahoma City, OK 73149

## Summer Store Hours:

Monday - Friday  
8 a.m. thru 6 p.m.  
Saturday  
8 a.m. thru 12 p.m.

## Winter Store Hours:

Monday - Friday  
8 a.m. thru 5 p.m.  
Saturday  
8 a.m. thru 12 p.m.  
(Central Standard Time)

WE ACCEPT VISA • DISCOVER  
MASTERCARD

check us out at  
[www.classicautoparts.com](http://www.classicautoparts.com)

NEXT DAY AIR  
SERVICE AVAILABLE  
ON ALL ORDERS!

# Buy Now

# 1962-72 Fairlane

## 3" Fuzzy Hanging Dice



- Black with/ White Dots  
(Stock # V17-27225-070)  
**OEM # B-17900-B pair . . . . . 4.95**
- Blue with/ White Dots  
(Stock # V17-27225-080)  
**OEM # B-17900-N pair . . . . . 4.95**
- Red with/ White Dots  
(Stock # V17-27225-085)  
**OEM # B-17900-R pair . . . . . 4.95**
- Pink with Black Dots  
(Stock # V17-27225-082)  
**OEM # B-17900-P pair. . . . . 5.95**
- White with/ Black Dots  
(Stock # V17-27225-090)  
**OEM # B-17900-W pair. . . . . 4.95**



### Flaming Fuzzy Dice

Black dice with red/orange/yellow flames.  
3" diameter dice.  
**OEM # B-17900-FL pair. . . . . 6.50**



### Lucky 8 Balls

Fuzzy Black. 3" Diameter  
(Stock # V17-27225-065)  
**OEM # B-17900-8BALL pair. . . . . 4.95**



### Logo Ball Cap with Flames

- Black adjustable ball cap with Ford® logo and flames on the bill.
- Red Flames  
**M-99-FLRF each. . . . . 20.95**
- Yellow Flames  
**M-99-FLYF each. . . . . 26.95**
- Blue Flames  
**M-99-HATBF each . . . . . 26.95**



### Leather Key Fobs

- Ford®  
**KR-1 each. . . . . 0.00**
- Torino  
**KR-121 each. . . . . 0.00**



### Ford® Script Ball Cap

Adjustable  
**FC-99-BC each . . . . . 9.95**

**Ford® Script White Gatsby Cap**  
**FC-99-GC each . . . . . 18.95**

**I want you to check out our website for easy shopping and current prices for anything you may need. Don't want to order on-line? Just give us a call and we'll be happy to help!**



### T-shirts

- These are the very best of quality and top name brand.
- TS-99-MM Medium. . . . . 14.95**
  - TS-99-ML Large . . . . . 12.95**
  - TS-99-MXL Xtra-Large . . . . . 12.95**
  - TS-99-MXXL XXL . . . . . 16.95**



Restoration Supplies

**Check out our website for information, and to check on current prices!**

# 1962-72 Fairlane

Restoration Supplies



### Billet Aluminum Lighted Tag Frame Assembly

Brushed billet aircraft aluminum with anodized finish designed to look good in any weather. Complete with light assembly and all wiring and mounting hardware. Great safety item plus a very attractive piece!

(Stock # P13-20640-405)

**OEM #BA-13409-PL each . . . . . 89.95**



### Basic Chrome Tag Frame

Ideal for any car. Just a classy chrome piece designed to frame your tag.

(Stock # V13-20640-220)

**OEM # B-13409-ALC each . . . . . 7.95**



### Billet Style Aluminum License Plate Frame

Brushed Finish

Ford® and Mercury® All

(Stock # Z13-20640-740)

**OEM # U-13409-BBF each . . . . . 32.95**

Chrome finish

Ford® and Mercury® All

(Stock # Z13-20640-745)

**OEM # U-13409-BCF each . . . . . 38.95**



### Year Specific Classic Tag Frame

Chrome plated with blue background and white lettering. Great accessory item!

1962 Classic

(Stock # P13-20640-455)

**OEM # C2AZ-13409 each . . . . . 5.95**

1963 Classic

(Stock # P13-20640-470)

**OEM # C3AZ-13409 each . . . . . 5.95**

1964 Classic

(Stock # P13-20640-485)

**OEM # C4AZ-13409 each . . . . . 5.95**

1965 Classic

(Stock # P13-20640-500)

**OEM # C5AZ-13409 each . . . . . 5.95**

1966 Classic

(Stock # P13-20640-515)

**OEM # C6AZ-13409 each . . . . . 5.95**

1967 Classic

(Stock # P13-20640-525)

**OEM # C7AZ-13409 each . . . . . 5.95**

1968 Classic

(Stock # P13-20640-535)

**OEM # C8AZ-13409 each . . . . . 5.95**

1969 Classic

(Stock # P13-20640-545)

**OEM # C9AZ-13409 each . . . . . 5.95**

1970 Classic

(Stock # P13-20640-555)

**OEM # D0AZ-13409 each . . . . . 5.95**

1971 Classic

(Stock # P13-20640-555)

**OEM # D1AZ-13409 each . . . . . 5.95**

1972 Classic

(Stock # P13-20640-575)

**OEM # D2AZ-13409 each . . . . . 5.95**



### Ford® License Plate

White with blue Ford® oval

1949-74 Ford®

(Stock # Z13-20640-630)

**OEM # LP-13409-FO each . . . . . 0.00**

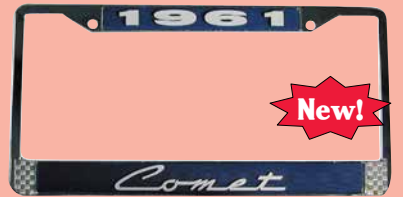

### Logo License Plate Frames

Personalize your classic with these chrome frames. Will not fit cars with a bottom hinge frame. Logo is white with Ford® blue background.

Fairlane

(Stock # Z13-20640-622)

**OEM # LP-13409-FL each . . . . . 0.00**

Comet

(Stock # Z13-20620-559)

**OEM # LP-13409-CO each . . . . . 0.00**

Ranchero

(Stock # Z13-20640-648)

**OEM # LP-13409-RA each . . . . . 0.00**

Torino

(Stock # Z17-20640-651)

**OEM # LP-13409-TO each . . . . . 8.95**



### License Plate Mounting Kit

All chrome plated - ready to install

(Stock # V13-20640-285)

**OEM # B-13409-MB kit . . . . . 4.95**



### License Plate Mounting Kit

Nylon push in nuts

(Stock # P13-20640-420)

**OEM # C0AZ-13409-MB set . . . . . 1.95**



### License Plate Rubber Bumper

For the rear bumper - requires 2

1962-69 All

(Stock # P13-20640-425)

**OEM # C0AZ-13409-RB each . . . . . 1.95**

We're Thankful For Your Business

**We have EVERYTHING you want!**

**Call Us  
1-800-654-3247**

# 1962-72 Fairlane

## • Air Cleaner Decals • Air Cleaner Decals • Air Cleaner Decals •

DF-100-83

DF-100-352

DF-100-350

- 1962**
- Fairlane 170 C.I.D. air cleaner decal **DF-100-95 each . . . . . 8.95**
  - Fairlane 221 C.I.D. air cleaner decal **DF-100-418 each . . . . . 8.95**
  - Fairlane 260 C.I.D. air cleaner decal **DF-100-45 each . . . . . 8.95**
  - Fairlane 289 C.I.D. air cleaner decal **DF-100-45 each . . . . . 8.95**
  - Fairlane air cleaner service instruction decal **DF-100-83 each . . . . . 9.95**
  - Fairlane air cleaner service decal with air conditioning **DF-100-340 each . . . . . 8.95**
  - Fairlane Autolite spark plug air cleaner decal - V8 **DF-100-160 each . . . . . 8.95**
  - Fairlane Autolite spark plug air cleaner decal - 6 cylinder **DF-100-352 each . . . . . 8.95**
  - Fairlane crankcase vent air cleaner decal **DF-100-350 each . . . . . 8.95**

DF-100-83

DF-100-149

DF-100-350

- 1963**
- Fairlane 170 C.I.D. air cleaner decal **DF-100-95 each . . . . . 8.95**
  - Fairlane 221 C.I.D. air cleaner decal **DF-100-418 each . . . . . 8.95**
  - Fairlane 260 C.I.D. air cleaner decal **DF-100-45 each . . . . . 8.95**
  - Fairlane air cleaner service instruction decal **DF-100-83 each . . . . . 9.95**
  - Fairlane air cleaner service decal with AC **DF-100-340 each . . . . . 8.95**
  - Fairlane Autolite spark plug - V8 **DF-100-160 each . . . . . 8.95**
  - Fairlane Autolite spark plug - 6 cylinder **DF-100-352 each . . . . . 8.95**

DF-100-83

DF-100-160

DF-100-350

- 1964**
- Fairlane 170 C.I.D. air cleaner decal **DF-100-95 each . . . . . 8.95**
  - Fairlane 221 C.I.D. air cleaner decal **DF-100-418 each . . . . . 8.95**
  - Fairlane 260 C.I.D. air cleaner decal **DF-100-45 each . . . . . 8.95**
  - Fairlane 289 C.I.D. air cleaner decal **DF-100-13 each . . . . . 8.95**
  - Fairlane Air cleaner "FRONT" decal **DF-100-150 each . . . . . 8.95**
  - Fairlane Air cleaner service instruction decal **DF-100-83 each . . . . . 9.95**
  - Fairlane Autolite spark plug - V8 **DF-100-160 each . . . . . 8.95**
  - Fairlane Autolite spark plug - 6 cylinder **DF-100-352 each . . . . . 8.95**
  - Fairlane crankcase vent air cleaner decal **DF-100-350 each . . . . . 8.95**

DF-100-149

DF-100-150

DF-100-1300

- 1965**
- Fairlane 200 C.I.D. air cleaner decal **DF-100-355 each . . . . . 8.95**
  - Fairlane 289 C.I.D. air cleaner decal **DF-100-1300 each . . . . . 8.95**
  - Fairlane 289 4V premium fuel air cleaner decal **DF-100-14 each . . . . . 8.95**
  - Fairlane 289 Hi-Perf air cleaner decal **DF-100-15 each . . . . . 8.95**
  - Fairlane air cleaner "FRONT" decal **DF-100-150 each . . . . . 8.95**
  - Fairlane air cleaner service instruction decal **DF-100-149 each . . . . . 8.95**
  - Fairlane air cleaner service instruction decal **DF-100-83 each . . . . . 9.95**
  - Fairlane Autolite spark plug - V8 **DF-100-160 each . . . . . 8.95**
  - Fairlane Autolite spark plug - 6 cylinder **DF-100-352 each . . . . . 8.95**
  - Fairlane crankcase vent air cleaner decal **DF-100-350 each . . . . . 8.95**

DL-100-134

DF-100-150

DL-100-14

DL-100-15

DF-100-1334

DF-100-53

- 1966**
- Fairlane 200 C.I.D. air cleaner decal **DF-100-355 each . . . . . 8.95**
  - Fairlane 289 C.I.D. air cleaner decal **DF-100-1300 each . . . . . 8.95**
  - Fairlane 390 C.I.D. air cleaner decal **DF-100-53 each . . . . . 8.95**
  - Fairlane 390 4V premium fuel air cleaner decal **DF-100-1145 each . . . . . 8.95**
  - Fairlane 427 (4V) air cleaner decal **DF-100-1334 each . . . . . 8.95**
  - Fairlane air cleaner "FRONT" decal **DF-100-150 each . . . . . 8.95**
  - Fairlane air cleaner service instruction decal **DF-100-149 each . . . . . 8.95**
  - Fairlane Autolite spark plug - V8 **DF-100-160 each . . . . . 8.95**
  - Fairlane Autolite spark plug - 6 cylinder **DF-100-352 each . . . . . 8.95**
  - Fairlane crankcase vent air cleaner decal **DF-100-350 each . . . . . 8.95**
  - Fairlane 289 C.I.D. Ranchero **DF-100-13 each . . . . . 8.95**
  - Fairlane 289 4V premium fuel - Ranchero **DF-100-14 each . . . . . 8.95**
  - Comet 200 cubic inch air cleaner decal **DL-100-14 each . . . . . 8.95**
  - Comet 289 2V air cleaner decal **DL-100-15 each . . . . . 8.95**
  - Comet 289 2V air cleaner decal **DL-100-313 each . . . . . 8.95**
  - Comet 390 2V air cleaner decal **DL-100-134 each . . . . . 9.95**
  - Comet 390 4V air cleaner decal **DL-100-135 each . . . . . 9.95**

**See all our parts ONLINE!**  
**We stock many other lines of Ford®. Check us out at**  
**www.ClassicAutoParts.com**

Decals

# 1962-72 Fairlane

• Air Cleaner Decals • Air Cleaner Decals • Air Cleaner Decals •

Decals

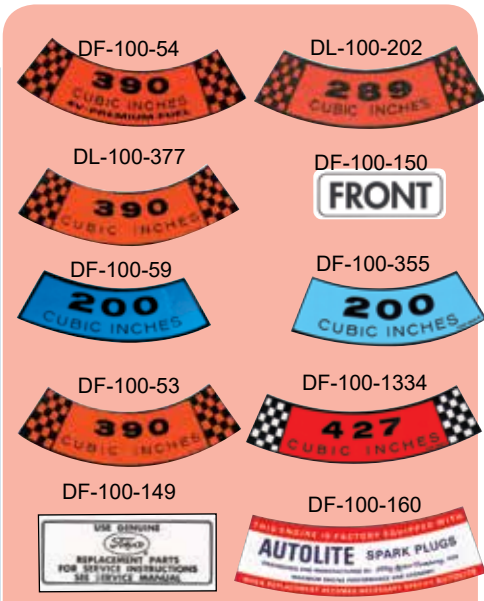

**1967**

- Fairlane 200 C.I.D. air cleaner decal  
**DF-100-355 each . . . . . 8.95**
- Fairlane 289 C.I.D. air cleaner decal  
**DF-100-1300 each . . . . . 8.95**
- Fairlane and Comet 390 C.I.D. air cleaner decal  
**DF-100-53 each . . . . . 8.95**
- Fairlane 390 4V premium fuel air cleaner decal  
**DF-100-54 each . . . . . 8.95**
- Fairlane 427 (4V) air cleaner decal  
**DF-100-1334 each . . . . . 8.95**
- Fairlane air cleaner "FRONT" decal  
**DF-100-150 each . . . . . 8.95**
- Fairlane air cleaner service instruction decal  
**DF-100-149 each . . . . . 8.95**
- Fairlane Autolite spark plug - V8  
**DF-100-160 each . . . . . 8.95**
- Fairlane Autolite spark plug - 6 cylinder  
**DF-100-352 each . . . . . 8.95**
- Fairlane crankcase vent air cleaner decal  
**DF-100-350 each . . . . . 8.95**
- Comet 200 cubic inch air cleaner decal  
**DF-100-59 each . . . . . 8.95**
- Fairlane and Comet 289 2V air cleaner decal  
**DF-100-104 each . . . . . 8.95**
- Comet 390 GT air cleaner decal  
**DF-100-392 each . . . . . 3.95**

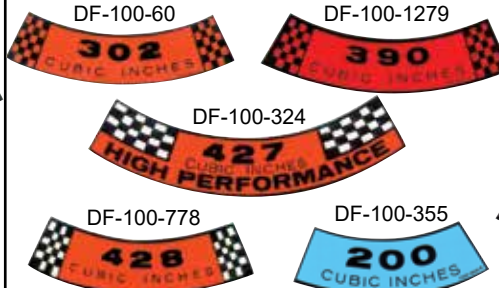

**1968**

- Fairlane 200 C.I.D. air cleaner decal  
**DF-100-355 each . . . . . 8.95**
- Fairlane 302 C.I.D. air cleaner decal  
**DF-100-60 each . . . . . 8.95**
- Fairlane 390 4V air cleaner decal  
**DF-100-1279 each . . . . . 8.95**
- Fairlane 427 4V premium fuel  
**DF-100-324 each . . . . . 8.95**
- Fairlane 428 C.I.D. air cleaner decal  
**DF-100-778 each . . . . . 8.95**
- Fairlane air cleaner "FRONT" decal  
**DF-100-150 each . . . . . 8.95**
- Fairlane air cleaner service instruction decal  
**DF-100-149 each . . . . . 8.95**
- Fairlane Autolite replacement parts with star  
**DF-100-1394 each . . . . . 9.95**
- Fairlane Autolite spark plug - 6 cylinder  
**DF-100-352 each . . . . . 8.95**
- Fairlane crankcase vent air cleaner decal  
**DF-100-350 each . . . . . 8.95**
- Fairlane Autolite part air cleaner decal 200  
**DF-100-1255 each . . . . . 9.95**
- Fairlane Autolite part air cleaner decal 302  
**DF-100-1188 each . . . . . 9.95**
- Fairlane Autolite parts air cleaner 390/428  
**DF-100-1187 each . . . . . 9.95**
- Fairlane 200 C.I.D. - Ranchero  
**DF-100-1332 each . . . . . 8.95**
- Fairlane 427 air cleaner decal - Ranchero  
**DF-100-1334 each . . . . . 8.95**
- Fairlane Autolite parts - Ranchero  
**DF-100-325 each . . . . . 8.95**
- Comet 289 air cleaner decal  
**DL-100-717 each . . . . . 5.00**
- Comet 302-2V air cleaner decal  
**DL-100-122 each . . . . . 5.95**
- Comet 302-4V air cleaner decal  
**DL-100-123 each . . . . . 0.00**
- Comet 390-2V air cleaner  
**DL-100-423 each . . . . . 9.95**
- Comet 390 C.I.D. air cleaner decal  
**DL-100-749 each . . . . . 5.00**
- Comet 390-4V air cleaner  
**DL-100-372 each . . . . . 5.95**
- Comet 390-4V air cleaner  
**DL-100-399 each . . . . . 15.95**

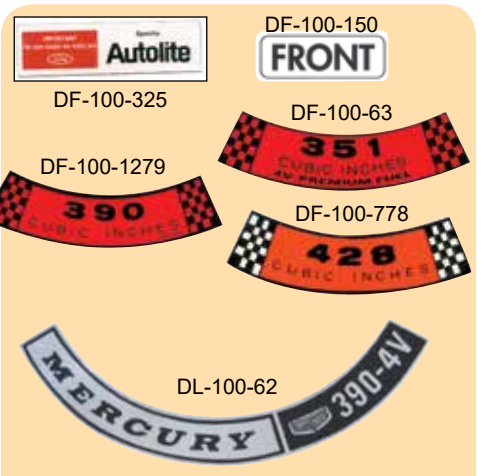

**1969**

- Fairlane 250 C.I.D. air cleaner decal  
**DF-100-443 each . . . . . 8.95**
- Fairlane 302 C.I.D. air cleaner decal  
**DF-100-60 each . . . . . 8.95**
- Fairlane 351 C.I.D. air cleaner decal  
**DF-100-62 each . . . . . 8.95**
- Fairlane 351 4V air cleaner decal  
**DF-100-63 each . . . . . 8.95**
- Fairlane 351 4V premium fuel air cleaner decal  
**DF-100-64 each . . . . . 0.00**
- Fairlane 390 4V air cleaner decal  
**DF-100-1279 each . . . . . 8.95**
- Fairlane 428 C.I.D. air cleaner decal  
**DF-100-778 each . . . . . 8.95**
- Fairlane air cleaner "FRONT" decal  
**DF-100-150 each . . . . . 8.95**
- Fairlane Autolite replacement parts  
**DF-100-325 each . . . . . 8.95**
- Fairlane Autolite part air cleaner decal 250  
**DF-100-1256 each . . . . . 9.95**
- Fairlane Autolite part air cleaner decal 302  
**DF-100-1188 each . . . . . 9.95**
- Fairlane Autolite parts air cleaner 390/428  
**DF-100-1187 each . . . . . 9.95**
- Comet 302-2V air cleaner decal  
**DL-100-321 each . . . . . 9.95**
- Comet 302-2V air cleaner decal  
**DL-100-301 each . . . . . 8.95**
- Comet 351-2V air cleaner decal  
**DL-100-64 each . . . . . 9.95**
- Comet 351-4V air cleaner decal  
**DL-100-303 each . . . . . 8.95**
- Comet 351-4V air cleaner decal  
**DL-100-65 each . . . . . 9.95**
- Comet 390-4V air cleaner  
**DL-100-62 each . . . . . 5.00**
- Comet 428 CJ Ram Air  
**DL-100-50 each . . . . . 9.95**
- Comet 428 CJ non Ram Air  
**DL-100-404 each . . . . . 15.95**



# 1962-72 Fairlane

• Air Cleaner Decals • Air Cleaner Decals • Air Cleaner Decals •



DF-100-182



DF-100-183

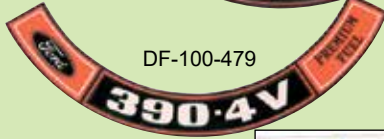

DF-100-479

**FRONT**

DF-100-150



DF-100-325

## 1970

- Fairlane 250 C.I.D. air cleaner decal  
**DF-100-172 each . . . . . 9.95**
- Fairlane 302 2V regular air cleaner decal  
**DF-100-182 each . . . . . 9.95**
- Fairlane 302 4V premium fuel air cleaner decal  
**DF-100-183 each . . . . . 9.95**
- Fairlane 351 2V regular air cleaner decal  
**DF-100-184 each . . . . . 9.95**
- Fairlane 351 4V premium air cleaner decal  
**DF-100-185 each . . . . . 9.95**
- Fairlane 400 C.I.D. air cleaner decal  
**DF-100-314 each . . . . . 8.95**
- Fairlane 390 4V premium air cleaner decal  
**DF-100-479 each . . . . . 9.95**
- Fairlane 428 4V Police Interceptor air cleaner  
**DF-100-485 each . . . . . 9.95**
- Fairlane 429 4V premium fuel air cleaner decal  
**DF-100-451 each . . . . . 9.95**
- Fairlane 429 4V Cobra Jet air cleaner decal  
**DF-100-395 each . . . . . 9.95**
- Fairlane 429 4V Cobra air cleaner decal  
**DF-100-245 each . . . . . 5.95**
- Fairlane air cleaner "FRONT" decal  
**DF-100-150 each . . . . . 8.95**
- Fairlane Autolite replacement parts  
**DF-100-325 each . . . . . 8.95**
- Fairlane 250 Autolite parts air cleaner decal  
**DF-100-1257 each . . . . . 8.95**
- Comet 200-6 air cleaner decal  
**DL-100-146 each . . . . . 9.95**
- Comet 250-1V air cleaner decal  
**DL-100-688 each . . . . . 5.00**



DL-100-305



DL-100-83



DF-100-325

## 1970 Continued

- Comet 302-2V air cleaner decal  
**DL-100-301 each . . . . . 8.95**
- Comet 302-2V air cleaner decal  
**DL-100-321 each . . . . . 9.95**
- Comet 351-4V air cleaner decal  
**DL-100-303 each . . . . . 8.95**
- Comet 351-2V air cleaner decal  
**DL-100-64 each . . . . . 9.95**
- Comet 351-4V air cleaner decal  
**DL-100-65 each . . . . . 9.95**
- Comet 429-4V air cleaner decal  
**DL-100-305 each . . . . . 15.95**
- Comet 429 CJ Ram Air air cleaner decal  
**DL-100-876 each . . . . . 6.50**
- Comet 429 CJ Ram Air air cleaner decal  
**DL-100-83 each . . . . . 9.95**
- Comet 429 CJ Non Ram Air air cleaner  
**DL-100-405 each . . . . . 15.95**

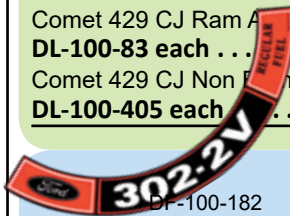

DF-100-182



DF-100-183

## 1971

- Fairlane 250 C.I.D. air cleaner decal  
**DF-100-172 each . . . . . 9.95**
- Fairlane 302 2V regular air cleaner decal  
**DF-100-182 each . . . . . 9.95**
- Fairlane 302 4V premium fuel air cleaner decal  
**DF-100-183 each . . . . . 9.95**
- Fairlane 351 2V regular air cleaner decal  
**DF-100-184 each . . . . . 9.95**
- Fairlane 351 4V premium air cleaner decal  
**DF-100-185 each . . . . . 9.95**
- Fairlane 390 4V premium air cleaner decal  
**DF-100-479 each . . . . . 9.95**



DL-100-83



DF-100-325



DL-100-305

**FRONT**

DF-100-150



DF-100-451

## 1971 Continued

- Fairlane 428 4V Police Interceptor air cleaner  
**DF-100-485 each . . . . . 9.95**
- Fairlane 429 4V premium fuel air cleaner decal  
**DF-100-451 each . . . . . 9.95**
- Fairlane 429 4V Cobra Jet air cleaner decal  
**DF-100-395 each . . . . . 9.95**
- Fairlane 429 4V Cobra air cleaner decal  
**DF-100-245 each . . . . . 5.95**
- Fairlane 429 4V Police Interceptor  
**DF-100-486 each . . . . . 9.95**
- Fairlane Autolite replacement parts air cleaner decal  
**DF-100-325 each . . . . . 8.95**
- Fairlane air cleaner "Front " decal  
**DF-100-150 each . . . . . 8.95**
- Montego 200-6 air cleaner decal  
**DL-100-740 each . . . . . 5.00**
- Montego 250-1V air cleaner decal  
**DL-100-688 each . . . . . 5.00**
- Montego 302-2V air cleaner decal  
**DL-100-321 each . . . . . 9.95**
- Montego 302-2V air cleaner decal  
**DL-100-301 each . . . . . 8.95**
- Montego 351-2V air cleaner decal  
**DL-100-64 each . . . . . 9.95**
- Montego 351-4V air cleaner decal  
**DL-100-303 each . . . . . 8.95**
- Montego 351-4V air cleaner decal  
**DL-100-65 each . . . . . 9.95**
- Montego 429-4V air cleaner decal  
**DL-100-305 each . . . . . 15.95**
- Montego 429 CJ Non Ram Air air cleaner decal  
**DL-100-405 each . . . . . 15.95**
- Montego 429 CJ Ram Air air cleaner decal  
**DL-100-83 each . . . . . 9.95**

Decals

# 1962-72 Fairlane

## Air Cleaner Decals

## • Engine Compartment Decals •

Decals

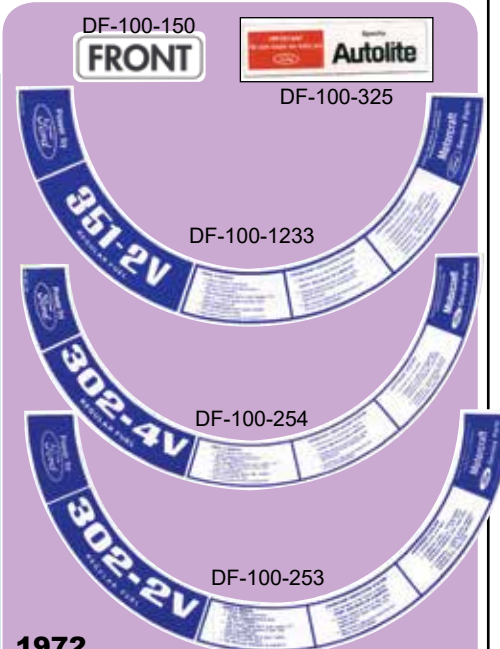

### 1972

- Fairlane 250 C.I.D. air cleaner decal  
**DF-100-1338 each . . . . . 9.95**
- Fairlane and Comet 302-2V regular fuel  
**DF-100-253 each . . . . . 9.95**
- Fairlane 351-2V regular fuel  
**DF-100-1233 each . . . . . 9.95**
- Fairlane and Comet 302-4V regular fuel  
**DF-100-254 each . . . . . 9.95**
- Fairlane 351-2V regular fuel  
**DF-100-255 each . . . . . 9.95**
- Fairlane 351 CJ regular fuel  
**DF-100-365 each . . . . . 9.95**
- Fairlane 351-4V regular fuel  
**DF-100-1232 each . . . . . 9.95**
- Fairlane 351-4V regular  
**DF-100-256 each . . . . . 9.95**
- Fairlane 400-2V regular fuel  
**DF-100-1346 each . . . . . 9.95**
- Fairlane 429-4V regular fuel  
**DF-100-181 each . . . . . 9.95**
- Fairlane Autolite replacement parts  
**DF-100-325 each . . . . . 8.95**
- Fairlane air cleaner "Front" decal  
**DF-100-150 each . . . . . 8.95**
- Montego 200 cubic inch  
**DL-100-810 each . . . . . 5.00**
- Montego 250-1V  
**DL-100-767 each . . . . . 5.00**
- Montego 351-2V  
**DL-100-741 each . . . . . 5.00**
- Montego 351-2V  
**DL-100-213 each . . . . . 9.95**
- Montego 400-2V  
**DL-100-768 each . . . . . 5.00**
- Montego 429-4V  
**DL-100-254 each . . . . . 9.95**

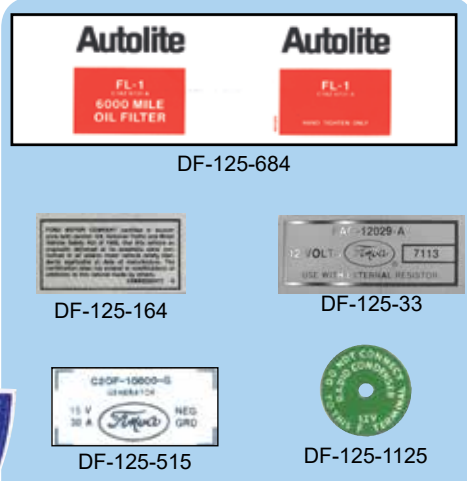

### 1962-64

- Oil Filler Cap Decal  
**DF-125-164 each . . . . . 8.95**
- Fairlane Autolite FL1 oil filter decal  
**DF-125-684 each . . . . . 9.95**
- Fairlane coil decal  
**DF-125-33 each . . . . . 9.95**
- Fairlane voltage regulator decal  
**DF-125-337 each . . . . . 9.95**
- Fairlane voltage regulator warning decals  
**DF-125-347 pair . . . . . 9.95**
- Fairlane generator decal  
**DF-125-515 each . . . . . 9.95**
- Fairlane generator radio warning tag  
**DF-125-1125 each . . . . . 8.95**
- Fairlane antifreeze tag  
**DF-125-461 each . . . . . 8.95**



### 1962-63

- Fairlane Rotunda oil filter decal - red  
**DF-125-613 each . . . . . 9.95**
- Fairlane factory battery test OK decal  
**DF-125-405 each . . . . . 8.95**



- 1962-65**  
FOMOCO® antifreeze tag  
**DF-125-120 each . . . . . 8.95**

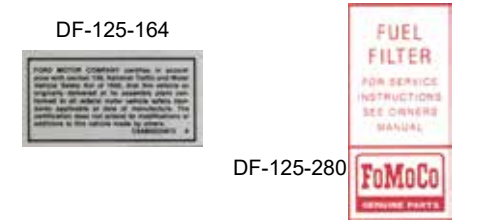

- 1962-66**  
Ford® oil filler cap decal  
**DF-125-164 each . . . . . 8.95**
- Ford® fuel filter decal  
**DF-125-280 each . . . . . 8.95**



- 1962-67**  
Fairlane starter decal - small block  
**DF-125-499 each . . . . . 9.95**



- 1962-70**  
Ford® and Mercury® air conditioner compressor aluminum tag  
**DF-125-351 each . . . . . 9.95**
- Ford® and Mercury® Autolite Sta-Ful battery tag  
**DF-125-784 each . . . . . 9.95**
- Ford® 170/200 PCV plastic ring  
**DF-125-988 each . . . . . 9.95**

*Check those prices on-line!  
See our website for current pricing.*

# 1962-72 Fairlane

## • Engine Compartment Decals • Engine Compartment Decals •

DF-125-746



DF-125-1157

### 1962-71

- Ford® 6000 mile/6 month lube sticker  
**DF-125-746 each** ..... 8.95
- Ford® paint OK "P" trunk decal - red  
**DF-125-1157 each** ..... 8.95



DF-125-198

### 1963-64

- Ford® "P" paint OK sticker  
**DF-125-1342 each** ..... 8.95
- Ford® battery caution decal  
**DF-125-198 each** ..... 8.95



DF-125-345



DF-125-498

### 1964

- Ford® voltage regulator decal - no air  
**DF-125-963 each** ..... 9.95
- Ford® voltage regulator decal - with air  
**DF-125-964 each** ..... 9.95
- Ford® starter decal - big block  
**DF-125-498 each** ..... 9.95
- Ford® service specification decal  
**DF-125-345 each** ..... 8.95
- Ford® Do Not Add Water tag  
**DF-125-747 each** ..... 8.95



DF-125-550



DF-125-1130

### 1964-66

- Ford® air conditioner dryer decal  
**DF-125-550 each** ..... 8.95
- Ford® air conditioner sight glass decal  
**DF-125-1130 each** ..... 8.95



DF-125-353



DF-125-502

DF-125-699



### 1964-67

- Ford® transistorized ignition distributor decal  
**DF-125-502 each** ..... 9.95
- Ford® transistorized ignition shield decal  
**DF-125-353 each** ..... 9.95
- Ford® Rotunda antifreeze tag  
**DF-125-699 each** ..... 9.95



DF-125-783



DF-125-647

### 1964-69

- Ford® and Mercury® Autolite fl 11 racing oil filter decal  
**DF-125-783 each** ..... 9.95
- Ford® Rotunda 6000 mile oil filter decal  
**DF-125-647 each** ..... 9.95

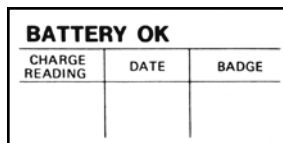

### 1964-72

- Ford® and Mercury® factory battery test OK decal  
**DF-125-194 each** ..... 8.95

**Friend us on Facebook and follow us on Twitter. You never know what you might be in for.**



DF-125-729



DF-125-992

### 1965

- Ford® disc brake warning tag  
**DF-125-729 each** ..... 8.95
- Ford® 260 PCV plastic ring EV42  
**DF-125-982 each** ..... 9.95
- Ford® 427 PCV plastic ring  
**DF-125-992 each** ..... 9.95

DF-125-412



### 1965-66

- Ford® and Mercury® voltage regulator decal  
**DF-125-412 each** ..... 9.95
- Ford® starter decal - big block  
**DF-125-1097 each** ..... 9.95
- Ford® and Mercury® service specification decal  
**DF-125-20 each** ..... 8.95

DF-125-20



DF-125-992

### 1965-67

- Ford® 289 Hi-performance PCV plastic ring  
**DF-125-992 each** ..... 9.95
- Mercury® starter decal - small block  
**DL-125-677 each** ..... 9.95
- Mercury® starter - big block  
**DL-125-699 each** ..... 9.95



### 1965-68

- Mercury® 289 Hi-Performance PCV plastic ring  
**DL-125-541 each** ..... 9.95



Decals

# 1962-72 Fairlane

## • Engine Compartment Decals • Engine Compartment Decals •

Decals

USE OF THIS TERMINAL FOR OTHER THAN RADIO SUPPRESSION WILL CAUSE ELEC. SYSTEM FAILURE

DF-125-320

DF-125-647



### 1965-70

- Ford® and Mercury® voltage regulator radio warning tag  
**DF-125-320 each** ..... 8.95
- Mercury® Rotunda 6000 mile oil filter decal  
**DF-125-647 each** ..... 9.95

DF-125-224

DF-125-991



### 1965-71

- Ford® 390 PCV plastic ring  
**DF-125-991 each** ..... 9.95
- Mercury® coil decal  
**DF-125-224 each** ..... 9.95
- Mercury® 352 and 390 PCV plastic ring  
**DL-125-540 each** ..... 9.95

DF-125-224

**CAUTION-FAN**

DF-125-31



### 1965-72

- Ford® coil decal  
**DF-125-224 each** ..... 9.95
- Ford® Autolite battery positive terminal decal  
**DF-125-1520 each** ..... 9.95
- Mercury® Autolite battery positive terminal tag  
**DL-125-865 each** ..... 9.95
- Ford® caution fan decal  
**DF-125-31 each** ..... 8.95



DF-125-331

DF-125-1123



### 1966

- Ford® 427 MT engine code decal  
**DF-125-1141 each** ..... 9.95
- Ford® fuel filter decal  
**DF-125-1123 each** ..... 8.95
- Ford® and Mercury® disc brake master cylinder decal  
**DF-125-331 each** ..... 8.95
- Mercury® 427 engine code decal  
**DL-125-721 each** ..... 5.00



DF-125-981

### 1966-67

- Ford® 427 PCV plastic ring EV42  
**DF-125-981 each** ..... 9.95
- Ford® 289 Hi-Performance MT engine code decal  
**DF-125-1274 each** ..... 8.95
- Ford® 289 Hi-Performance AT engine code decal  
**DF-125-1275 each** ..... 8.95
- Mercury® 427 PCV plastic ring  
**DL-125-530 each** ..... 9.95



### 1966-69

- Ford® 428 CJ/SCJ PCV plastic ring EV45  
**DF-125-983 each** ..... 9.95



DF-125-1123



DL-125-537

DF-125-647



### 1966-70

- Ford® Rotunda 6000 mile oil filter decal  
**DF-125-647 each** ..... 9.95
- Ford® Autolite fuel filter decal  
**DF-125-1123 each** ..... 8.95
- Mercury® 170 and 200 PCV plastic ring  
**DL-125-537 each** ..... 9.50

**CAUTION-FAN**

DF-125-31

DF-125-224



### 1966-71

- Ford® coil decal  
**DF-125-224 each** ..... 9.95
- Ford® caution fan decal  
**DF-125-31 each** ..... 8.95



DF-125-332



DF-125-348

### 1967

- Ford® and Mercury® voltage regulator disc brake master cylinder decal  
**DF-125-348 each** ..... 9.95
- Ford® and Mercury® disc brake master cylinder decal  
**DF-125-332 each** ..... 8.95
- Ford® 200 AT engine code decal  
**DF-125-1398 each** ..... 9.95
- Ford® 289-2V AT engine code decal  
**DF-125-1399 each** ..... 9.95
- Ford® 390-4V AT engine code decal  
**DF-125-1400 each** ..... 9.95
- Ford® 289 Hi-Performance MT engine code decal  
**DF-125-1274 each** ..... 8.95
- Ford® 289 Hi-Performance AT engine code decal  
**DF-125-1275 each** ..... 8.95

**L 236K**

DF-125-1276

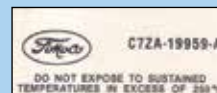

DF-125-866

**CAUTION-FAN**

DF-125-31

### 1967-68

- Ford® air conditioner dryer decal  
**DF-125-866 each** ..... 8.95
- Ford® 289-2V MT engine code decal  
**DF-125-1276 each** ..... 8.95
- Ford® 390 GT MT engine code decal  
**DF-125-1273 each** ..... 8.95
- Mercury® 289-2V MT engine code decal  
**DL-125-750 each** ..... 4.50
- Mercury® 390 GT engine code decal  
**DL-125-743 each** ..... 4.50
- Comet and Montego caution fan decal  
**DF-125-31 each** ..... 8.95



DF-125-52



DF-125-991

### 1967-69

- Ford® and Mercury® service specification decal  
**DF-125-52 each** ..... 8.95
- Ford® 390 PCV plastic ring  
**DF-125-991 each** ..... 9.95

IF YOU HAVE ANY QUESTIONS, JUST GIVE US A RING!



# 1962-72 Fairlane

## • Engine Compartment Decals • Engine Compartment Decals •

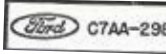

DF-125-548  
  
 DF-125-1123

### 1967-70

Ford® Autolite fuel filter decal  
**DF-125-1123 each . . . . . 8.95**  
 Ford® 428/429 carb fuel filter decal  
**DF-125-886 each . . . . . 8.95**  
 Ford® and Mercury® air conditioner clutch decal  
**DF-125-548 each . . . . . 8.95**



DF-125-460



DL-125-396

### 1967-71

Ford® 428/429 fuel filter decal  
**DF-125-886 each . . . . . 8.95**  
 Mercury® speed control decal  
**DL-125-396 each . . . . . 5.00**  
 Comet and Montego paint inspection OK decal set  
**DF-125-460 set . . . . . 8.95**

DF-125-700



DF-125-699



### 1967-72

Ford® speed control decal  
**DF-125-818 each . . . . . 9.95**  
 Ford® antifreeze tag  
**DF-125-700 each . . . . . 9.95**  
 Comet and Montego antifreeze tag  
**DF-125-699 each . . . . . 9.95**



DF-125-1276



DF-125-1270

### 1968

Ford® 427 PCV plastic ring EV42  
**DF-125-982 each . . . . . 9.95**  
 Ford® 428 PI AT engine code decal  
**DF-125-1270 each . . . . . 8.95**  
 Ford® 428 PI AT engine code decal  
**DF-125-1271 each . . . . . 8.95**  
 Ford® 428 CJ engine code decal  
**DF-125-1135 each . . . . . 8.95**  
 Ford® 428 CJ MT engine code decal  
**DF-125-1272 each . . . . . 8.95**  
 Ford® 289 2V MT engine code decal  
**DF-125-1276 each . . . . . 8.95**  
 Ford® 289 2V AT engine code decal  
**DF-125-1408 each . . . . . 9.95**  
 Ford® 302 4V AT engine code decal  
**DF-125-1406 each . . . . . 9.95**  
 Ford® 390 4V MT engine code decal  
**DF-125-1407 each . . . . . 9.95**  
 Ford® 390GT MT engine code decal  
**DF-125-1273 each . . . . . 8.95**  
 Mercury® 428 CJ engine code decal  
**DL-125-716 each . . . . . 4.50**  
 Mercury® 427 PCV plastic ring  
**DL-125-531 each . . . . . 9.95**



DF-125-983

### 1968-69

Ford® 428 CJ/SCJ PCV plastic ring  
**DF-125-983 each . . . . . 9.95**  
 Mercury® 428 CJ and 428 SCJ PCV plastic ring  
**DL-125-532 each . . . . . 9.95**



DF-125-967



DF-125-966

### 1968- Early 70

Ford® voltage regulator - no air  
**DF-125-966 each . . . . . 9.95**  
 Ford® voltage regulator - with air  
**DF-125-967 each . . . . . 9.95**  
 Mercury® voltage regulator with air  
**DL-125-543 each . . . . . 9.95**  
 Mercury® voltage regulator without air  
**DL-125-544 each . . . . . 9.95**



### 1968-72

Ford® and Mercury® voltage regulator Hi-Performance decal  
**DF-125-464 each . . . . . 9.95**

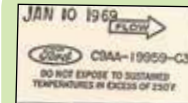

DF-125-656



DF-125-1265



DF-125-1260



DF-125-1264



DL-125-499

### 1969

Ford® and Mercury® air conditioner dryer decal  
**DF-125-656 each . . . . . 8.95**  
 Ford® Talladega 428 engine code decal  
**DF-125-1317 each . . . . . 8.95**  
 Ford® 428 CJ MT engine code decal - 420S  
**DF-125-1250 each . . . . . 8.95**  
 Ford® 428 CJ MT engine code decal - 420T  
**DF-125-1258 each . . . . . 8.95**  
 Ford® 428 CJ AT engine code decal - 421S  
**DF-125-1259 each . . . . . 8.95**  
 Ford® 428 CJ AT engine code decal - 421T  
**DF-125-1260 each . . . . . 8.95**  
 Ford® 428 SCJ MT engine code decal  
**DF-125-1263 each . . . . . 8.95**  
 Ford® 428 SCJ ST engine code decal - 425S  
**DF-125-1264 each . . . . . 8.95**  
 Ford® 428 SCJ AT engine code decal - 425T  
**DF-125-1265 each . . . . . 8.95**  
 Ford® 302 2V AT engine code decal  
**DF-125-1403 each . . . . . 9.95**  
 Ford® 390 4V AT engine code decal  
**DF-125-1402 each . . . . . 9.95**  
 Ford® 390 4V MT engine code decal  
**DF-125-1404 each . . . . . 9.95**  
 Ford® 428 SCJ MT engine code decal  
**DF-125-933 each . . . . . 8.95**  
 Mercury® 428 CJ engine code decal  
**DL-125-499 each . . . . . 4.50**

Decals

# 1962-72 Fairlane

## • Engine Compartment Decals • Engine Compartment Decals •

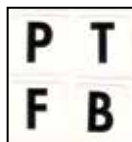

**1969-71**

Ford® paint OK decal set - 4 pieces

**DF-125-460 set . . . . . 8.95**



DF-125-31

**1969-72**

Ford® caution fan decal

**DF-125-31 each . . . . . 8.95**

Ford® speed control decal

**DF-125-818 each . . . . . 9.95**



DF-125-346



DF-125-987

**1970**

Ford® rev limiter decal

**DF-125-319 each . . . . . 8.95**

Ford® and Mercury® service specification decal

**DF-125-346 each . . . . . 8.95**

Ford® 351 PCV plastic ring EV50

**DF-125-985 each . . . . . 9.95**

Ford® 302/351 PCV plastic ring

**DF-125-987 each . . . . . 9.95**

Ford® 302-2V MT with air engine code decal - K273AG

**DF-125-1418 each . . . . . 9.95**

Ford® 302-2V MT with air engine code decal - K274AG

**DF-125-1419 each . . . . . 9.95**

Ford® 302-2V MT no air engine code decal - K279A

**DF-125-1420 each . . . . . 9.95**

Ford® 302-2V AT no air engine code decal **DF-125-1421 each . . . . . 9.95**

Ford® 351W-2V engine code decal

**DF-125-1268 each . . . . . 8.95**

Ford® 351W-4V MT engine code decal

**DF-125-1397 each . . . . . 9.95**

Torino 429CJ AT with air engine code decal

**DF-125-1592 each . . . . . 5.00**

Torino 429SCJ MT no air engine code decal

**DF-125-1595 each . . . . . 5.00**

Torino 429SCJ AT no air engine code decal

**DF-125-1596 each . . . . . 5.00**



DL-125-534



DF-125-549

DF-125-1268



**1970**

Ford® rev limiter decal

**DF-125-319 each . . . . . 8.95**

Ford® 351C 2V MT engine code decal

**DF-125-1327 each . . . . . 9.95**

Ford® 429 CJ MT without air engine code decal

**DF-125-1594 each . . . . . 5.00**

Mercury® 429 CJ AT without air engine code

**DL-125-886 each . . . . . 5.00**

Mercury® 351 PCV plastic ring

**DL-125-534 each . . . . . 9.95**

Mercury® 428 CJ and 428 SCJ PCV plastic ring

**DL-125-535 each . . . . . 9.95**



DF-125-984



DF-125-968



DL-125-545

**1970-71**

Ford® 429 CJ/SCJ PCV plastic ring EV48

**DF-125-984 each . . . . . 9.95**

Ford® 429/460 PCV plastic ring EV50

**DF-125-985 each . . . . . 9.95**

Ford® late 1970-71 voltage regulator, no air

**DF-125-968 each . . . . . 9.95**

Ford® late 1970-71 voltage regulator, with air

**DF-125-969 each . . . . . 9.95**

Ford® and Mercury® air conditioner dryer decal

**DF-125-549 each . . . . . 8.95**

Mercury® late 1970-71 voltage regulator with air decal

**DL-125-545 each . . . . . 9.95**

Mercury® late 1970-71 voltage regulator without air decal

**DL-125-546 each . . . . . 9.95**

Mercury® 429 CJ and 429 SCJ PCV plastic ring

**DL-125-533 each . . . . . 9.95**



DF-125-308



DF-125-974

**1971**

Ford® and Mercury® service specification decal

**DF-125-308 each . . . . . 8.95**

Ford® air conditioner charge decal

**DF-125-974 each . . . . . 9.95**

Torino 429CJ MT no air engine code decals

**DF-125-1593 each . . . . . 5.00**



DF-125-715

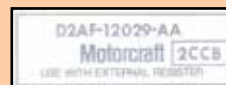

DL-125-336

**1972**

Ford® Motorcraft coil decal

**DF-125-715 each . . . . . 9.95**

Ford® voltage regulator decal without air

**DF-125-970 each . . . . . 9.95**

Ford® voltage regulator decal with air

**DF-125-971 each . . . . . 9.95**

Ford® Windsor air conditioner charge decal

**DF-125-551 each . . . . . 8.95**

Torino Motorcraft voltage regulator decal

**DF-125-714 each . . . . . 9.95**

Mercury® voltage regulator decal

**DL-125-337 each . . . . . 9.95**

Mercury® Motorcraft coil decal

**DL-125-336 each . . . . . 9.95**

Mercury® air conditioner charge decal - red

**DL-125-505 each . . . . . 9.00**

Mercury® air conditioner charge decal - purple

**DL-125-642 each . . . . . 4.50**



Autolite Sta-ful battery decal

**DZ-125-272 each . . . . . 9.95**

**Call Us:**  
**1-800-654-3247**

# 1962-72 Fairlane

## • Valve Cover Decals • Valve Cover Decals • Valve Cover Decals •



### 1962-65

Fairlane "Police Interceptor" valve cover decal

**DF-150-416 each . . . . . 9.95**



### 1964-66

Fairlane 427 Eagle with trans ignition valve cover decal

**DF-150-349 each . . . . . 9.95**



DF-150-535



### 1966

DF-150-110

Ford® 289 Special valve cover decal

**DF-150-535 each . . . . . 0.00**

Ford® 289 High-Performance valve cover decal

**DF-150-372 each . . . . . 0.00**

Ford® 427 Eagle valve cover decal

**DF-150-110 each . . . . . 0.00**

Ford® 427 Eagle with trans ignition valve cover decal

**DF-100-349 each . . . . . 6.00**



Powered by Ford® valve decal - blue on silver

**DF-150-410 each . . . . . 0.00**



Powered by Ford® valve decal - blue on white

**DF-150-411 each . . . . . 0.00**



Ford® 289 Cobra powered 271 HP decal

**DF-150-373 each . . . . . 0.00**

Ford® 289 Hi-Performance valve cover decal

**DF-150-372 each . . . . . 0.00**

Ford® Boss 302 valve cover decals

**DF-150-138 pair . . . . . 0.00**

Ford® Boss 351 valve cover decals

**DF-150-394 pair . . . . . 0.00**



Ford® 390 Hi-performance 355 HP decal

**DF-150-624 each . . . . . 0.00**

Ford® 428 Cobra-Jet 335 HP decal

**DF-150-1041 each . . . . . 0.00**



Ford® 428 Cobra-Jet 360 HP decal

**DF-150-1040 each . . . . . 0.00**

Ford® 428 Cobra-Jet 370 HP decal

**DF-150-834 each . . . . . 0.00**

Ford® 406 Eagle valve cover decal

**DF-150-731 each . . . . . 0.00**



Ford® 427 Eagle valve cover decal

**DF-150-110 each . . . . . 0.00**

Ford® 460 Eagle valve cover decal

**DF-150-1133 each . . . . . 0.00**



Ford® powered by 460 decals

**DF-150-596 pair . . . . . 0.00**

Ford® powered by 429 decals

**DF-150-597 pair . . . . . 0.00**

Ford® powered by 429 CJ decals

**DF-150-598 pair . . . . . 0.00**

Ford® powered by 429 SCJ decals

**DF-150-599 pair . . . . . 0.00**

Ford® powered by 428 decals

**DF-150-600 pair . . . . . 0.00**

Ford® powered by 428 CJ decals

**DF-150-601 pair . . . . . 0.00**

Ford® powered by 428 SCJ decals

**DF-150-602 pair . . . . . 0.00**



Ford® powered by 390 decals

**DF-150-603 pair . . . . . 0.00**

Ford® powered by 390 Hi-Performance decals

**DF-150-604 pair . . . . . 0.00**

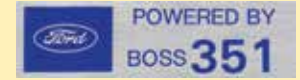

Ford® powered by 351 decals

**DF-150-605 pair . . . . . 0.00**

Ford® powered by Boss 351 decals

**DF-150-616 pair . . . . . 0.00**

Ford® powered by 351 Hi-Performance decals

**DF-150-606 pair . . . . . 0.00**

Ford® powered by 302 decals

**DF-150-607 pair . . . . . 0.00**

Ford® powered by 302 Hi-Performance decals

**DF-150-608 pair . . . . . 0.00**



Ford® powered by 289 decals

**DF-150-609 pair . . . . . 0.00**

Ford® powered by 298 Hi-Performance decals

**DF-150-610 pair . . . . . 0.00**

Ford® powered by 427 decals

**DF-150-611 pair . . . . . 0.00**

Ford® powered by 406 decals

**DF-150-612 pair . . . . . 0.00**

Ford® powered by 302 Windsor decals

**DF-150-614 pair . . . . . 0.00**

Ford® powered by Boss 302 decals

**DF-150-615 pair . . . . . 0.00**

Ford® powered by 428 Cobra-Jet decals

**DF-150-617 pair . . . . . 0.00**

Ford® powered by 428 Super Cobra-Jet decals

**DF-150-618 pair . . . . . 0.00**



Ford® powered by 429 Cobra-Jet decals

**DF-150-619 pair . . . . . 0.00**

Ford® powered by 429 Super Cobra-Jet decals

**DF-150-620 pair . . . . . 0.00**

Ford® powered by 351 Windsor decals

**DF-150-621 pair . . . . . 0.00**

Ford® powered by 351 Cleveland decals

**DF-150-622 pair . . . . . 0.00**

# 1962-72 Fairlane

• Emission Decals • Emission Decals • Emission Decals •

Decals

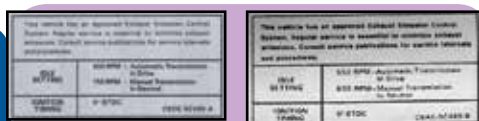

DF-175-1378



DF-175-562

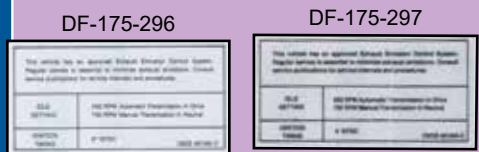

DF-175-296

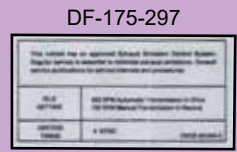

DF-175-297

## 1968

Ford® 200 AT/MT, Mercury® 200-1V AT/MT, Mercury® 302 and 351-2V AT/MT, and Mercury® 390 and 428-4V AT/MT emission decal

**DF-175-296 each . . . . . 9.95**

Ford® 289/302/390 emission decal

**DF-175-1378 each . . . . . 9.95**

Ford® 390GT AT/MT and Mercury® 302 and 351-4V AT/MT emission decal

**DF-175-562 each . . . . . 9.95**

Ford® 427 ST emission decal

**DF-175-1426 each . . . . . 9.95**

Ford® 428 CJ AT/MT emission decal

**DF-175-297 each . . . . . 9.95**

Mercury® 289, 302 and 390 emission decal

**DL-175-800 each . . . . . 5.00**



DF-175-563

## 1969

Ford® 250-1V AT/MT emission decal

**DF-175-296 each . . . . . 9.95**

Ford® 302-3V AT/MT and Mercury® 302 and 351-4V AT/MT emission decal

**DF-175-563 each . . . . . 9.95**

Ford® 351-2V AT/MT emission decal

**DF-175-1374 each . . . . . 9.95**

Ford® 351-4V AT/MT emission decal

**DF-175-1162 each . . . . . 9.95**

Ford® 390 AT/MT emission decal

**DF-175-782 each . . . . . 9.95**

Ford® 428 CJ AT/MT emission decal

**DF-175-297 each . . . . . 9.95**

Mercury® 351-2V AT/MT emission decal

**DL-175-801 each . . . . . 5.00**

Mercury® 351-4V AT/MT emission decal

**DL-175-637 each . . . . . 5.00**

Mercury® 390 GT AT/MT emission decal

**DL-175-356 each . . . . . 9.95**

## 1970

Ford® 250 AT/MT emission before 10-1  
**DF-175-1366 each . . . . . 9.95**

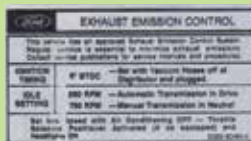

Ford® 250 AT/MT emission 10-1/1-1  
**DF-175-772 each . . . . . 9.95**

Ford® 250 AT/MT emission after 1-1-70

**DF-175-1352 each . . . . . 9.95**

Ford® 302-2V AT/MT emission before 10-1

**DF-175-1368 each . . . . . 9.95**

Ford® 302-2V AT/MT emission 10-1/1-1

**DF-175-1225 each . . . . . 9.95**



Ford® 302-2V MT emission after 1-1-70  
**DF-175-304 each . . . . . 9.95**

Ford® 351-2V AT/MT emission before 10-1

**DF-175-1379 each . . . . . 9.95**

Ford® 351-2V emission 10-1/1-1

**DF-175-277 each . . . . . 9.95**

Ford® 351C-2V AT/MT emission 10-1/1-1

**DF-175-1298 each . . . . . 9.95**

Ford® 351-4V AT/MT emission before 10-1

**DF-175-1195 each . . . . . 9.95**

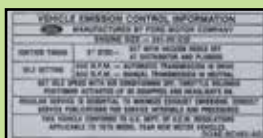

Ford® and Mercury® 351-4V AT/MT emission after 1-1

**DF-175-742 each . . . . . 9.95**

Ford® 428-4V CJ AT/MT emission before 10-1

**DF-175-1362 each . . . . . 5.00**

Ford® and Mercury® 429-4V AT/MT emission before 10-1

**DF-175-585 each . . . . . 9.95**

Ford® and Mercury® 429-4V AT/MT emission 10-1/1-1

**DF-175-452 each . . . . . 9.95**

Ford® and Mercury® 429-4V AT/MT emission after 1-1

**DF-175-667 each . . . . . 9.95**

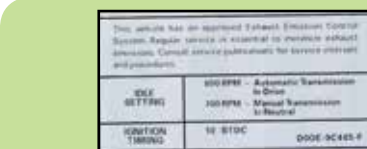

## 1970

Ford® 429CJ AT/MT emission before 10-1  
**DF-175-1365 each . . . . . 9.95**

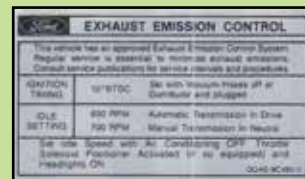

Ford® 429CJ AT/MT emission 10-1/1-1  
**DF-175-889 each . . . . . 9.95**

Ford® 429CJ AT/MT emission after 1-1  
**DF-175-881 each . . . . . 9.95**



Ford® California emission decal  
**DF-175-954 each . . . . . 9.95**

Ford® California evaporation emission control decal

**DF-175-650 each . . . . . 9.95**

Mercury® 250-1V AT/MT emission decal before 10-1

**DL-175-803 each . . . . . 5.00**

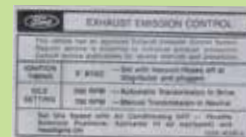

Mercury® 250 AT/MT emission decal  
**DL-175-346 each . . . . . 9.95**

Mercury® 250-1V AT/MT emission after 1-1-70

**DL-175-804 each . . . . . 5.00**

Mercury® 302-2V AT/MT emission before 10-1

**DL-175-805 each . . . . . 5.00**

Mercury® 302-2V MT emission decal before 1-1-70

**DL-175-607 each . . . . . 5.00**

Mercury® 302-2V MT emission decal after 1-1-70

**DF-175-311 each . . . . . 9.95**

Mercury® 302 AT/MT California emission decal

**DL-175-734 each . . . . . 5.00**

# 1962-72 Fairlane

• Emission Decals • Emission Decals • Emission Decals •

## 1970

- Mercury® 351-2V AT/MT emission before 10-1-70  
**DL-175-806 each** ..... 5.00
- Mercury® 351-2V AT emission decal before 10-1/1-1  
**DL-175-790 each** ..... 5.00
- Mercury® 351C 2V AT/MT emission decal after 10-1/1-1  
**DL-175-791 each** ..... 5.00
- Mercury® 351-4V AT/MT emission before 10-1  
**DL-175-792 each** ..... 5.00
- Mercury® 429 CJ AT/MT emission decal before 10-1  
**DL-175-807 each** ..... 5.00

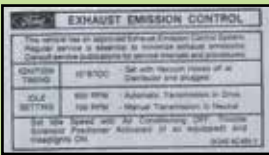

- Mercury® 429 CJ AT/MT emission before 10-1/1-1-70  
**DL-175-448 each** ..... 9.95
- Mercury® 429 CJ AT/MT emission after 1-1-70  
**DL-175-449 each** ..... 9.95



- Mercury® California emission expansion tank caution decal  
**DL-175-496 each** ..... 9.95
- Mercury® California emission control evaporation decal  
**DL-175-519 each** ..... 5.00

DF-175-763



## 1971

- Ford® 302-2V AT/MT emission decal  
**DF-175-763 each** ..... 9.95
- Ford® 351-2V AT emission decal  
**DF-175-554 each** ..... 9.95
- Ford® 429SCJ emission decal Torino  
**DF-175-1601 each** ..... 9.95
- Ford® 351-4V AT/MT emission decal  
**DF-175-762 each** ..... 9.95
- Ford® and Mercury® 429-4V AT emission decal  
**DF-175-552 each** ..... 9.95
- Ford® 429 CJ AT/MT and Mercury® 429-4V CJ AT/MT emission decal  
**DF-175-555 each** ..... 9.95
- Mercury® 200 six cylinder AT/MT emission decal  
**DL-175-347 each** ..... 9.95
- Mercury® 302-2V AT emission decal  
**DL-175-714 each** ..... 5.00
- Mercury® 351-2V AT/MT emission decal  
**DL-175-241 each** ..... 5.00

We accept these MAJOR credit cards.



1-800-654-3247

Call Us for All-American Deals

DF-175-594



DF-175-431



DF-175-843

DF-175-534

## 1972

- Ford® 302-2V AT/MT emission decal  
**DF-175-843 each** ..... 9.95
- Ford® and Mercury® 351-2V emission after 1-72 - yellow  
**DF-175-431 each** ..... 9.95
- Ford® and Mercury® 351C-2V AT/MT emission decal  
**DF-175-594 each** ..... 9.95
- Ford® early 351-4V AT and Mercury® 351C-4V AT/MT emission - yellow  
**DF-175-534 each** ..... 9.95
- Ford® late 351-4V AT emission - orange  
**DF-175-1414 each** ..... 9.95
- Ford® 400-2V AT emission decal  
**DF-175-1171 each** ..... 9.95
- Ford® 351-2V AT emission late - orange  
**DF-175-1173 each** ..... 9.95
- Mercury® 302-2V AT/MT emission decal  
**DL-175-475 each** ..... 9.95
- Mercury® 351-2V AT emission before 1-72 - orange  
**DL-175-640 each** ..... 5.00
- Mercury® 351-4V AT emission decal - late  
**DL-175-808 each** ..... 5.00
- Mercury® 400-2V AT emission decal  
**DL-175-639 each** ..... 5.00

Friend us on Facebook and follow us on Twitter. You never know what you might be in for.



Decals

Our standard ground service is shipped by FedEx. If you desire another carrier, let us know when you place your order, and we'll get you the details.

# 1962-72 Fairlane

• Interior Decals • Interior Decals • Interior Decals •

Decals



**1962**  
Fairlane factory build sheet  
DF-200-422 each ..... 9.95



**1962-65**  
Fairlane sun visor starting instruction sleeve  
DF-200-1140 each ..... 9.95



**1962-66**  
Ford® seat belt retractor diagram tag  
DF-200-1445 each ..... 9.95



**1962-67**  
Fairlane black sill plate decal  
DF-200-370 each ..... 9.00



**1962-69**  
Ford® caution driven tag  
DF-200-208 each ..... 9.95



**1962-72**  
Ford® final inspection window decal - green  
DF-200-1055 each ..... 8.95  
Ford® final inspection window decal - red  
DF-200-1056 each ..... 8.95



DF-200-285

**1963**  
Ford® early 1963 Fairlane new car window price sticker  
DF-200-285 each ..... 9.95  
Ford® late 1963 Fairlane new car window price sticker  
DF-200-85 each ..... 9.95  
Fairlane factory build sheet  
DF-200-421 each ..... 9.95



**1963-65**  
Ford® subsequent owner's registration sheet  
DF-200-702 each ..... 8.95

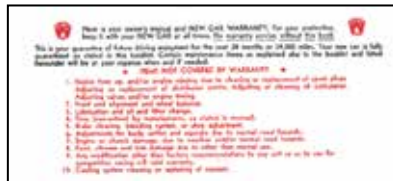

**1963-66**  
Fairlane owner's manual envelope  
DF-200-336 each ..... 8.95

Save on shipping by watching for our Free Freight e-mails. You can join our e-mail club at [www.ClassicAutoParts.com](http://www.ClassicAutoParts.com)

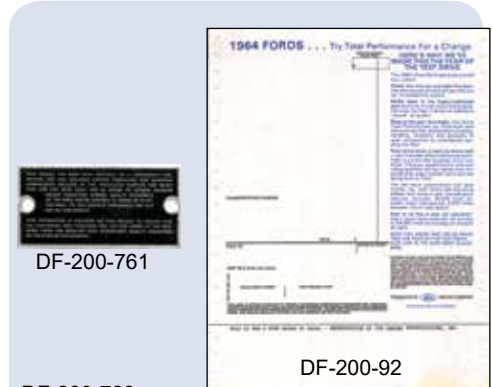

DF-200-761

DF-200-92

DF-200-723

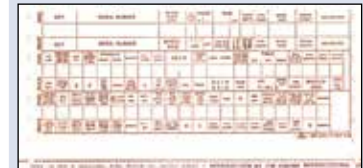

**1964**  
Fairlane lightweight glove box plate  
DF-200-761 each ..... 15.95  
Fairlane new car window price sticker  
DF-200-92 each ..... 9.95  
Fairlane factory build sheet  
DF-200-723 each ..... 9.95



**1964-66**  
Fairlane and Ranchero reverberation decal  
DF-200-651 each ..... 9.95



**1964-67**  
Fairlane seat belt retractor installation tag  
DF-200-305 each ..... 8.95



**1964-70**  
Ford® Detroit locker glove box decal  
DF-200-429 each ..... 9.95

**Call Us:**  
**1-800-654-3247**

# 1962-72 Fairlane

• Interior Decals • Interior Decals • Interior Decals •

Decals

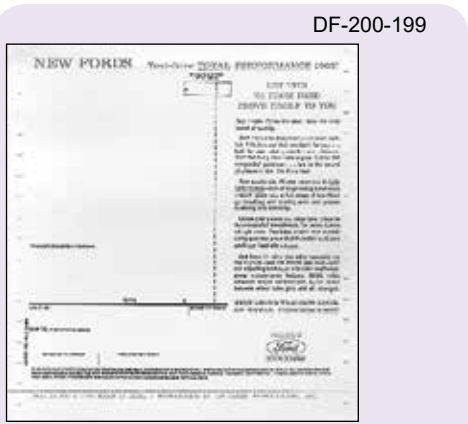

DF-200-199





DF-200-1110

**1965**  
Fairlane new car window price sticker  
**DF-200-199 each . . . . . 9.95**  
Fairlane factory build sheet  
**DF-200-1110 each . . . . . 9.95**



**1965-66**  
Comet interval wiper instruction tag  
**DL-200-79 each . . . . . 8.95**

DL-200-595  **UTICA PLANT QUALITY BUILT**

 

DL-200-527 DL-200-526

**1965-72**  
Mercury® final inspection window decal - green  
**DL-200-526 each . . . . . 8.95**  
Mercury® final inspection window decal - red  
**DL-200-527 each . . . . . 0.00**  
Mercury® Convertible top Utica plant decal  
**DL-200-595 each . . . . . 0.00**



**We love when our customers bring their cars and trucks by. Feel free to drive yours up and show it off.**

DF-200-743 

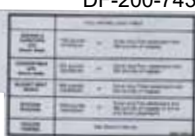
DF-200-863 

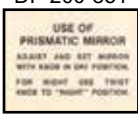
DF-200-851 

DL-200-221 

**1966**  
Fairlane tire pressure decal  
**DF-200-743 each . . . . . 9.95**  
Fairlane and Rancho new car warranty sheet  
**DF-200-863 each . . . . . 8.95**  
Early 1966 Fairlane and Rancho new car window price sticker  
**DF-200-42 each . . . . . 9.95**  
Late 1966 Fairlane and Rancho new car window price sticker  
**DF-200-1202 each . . . . . 9.95**  
Fairlane and Rancho factory build sheet  
**DF-200-1106 each . . . . . 9.95**  
Fairlane prismatic mirror instruction decal  
**DF-200-851 each . . . . . 8.95**

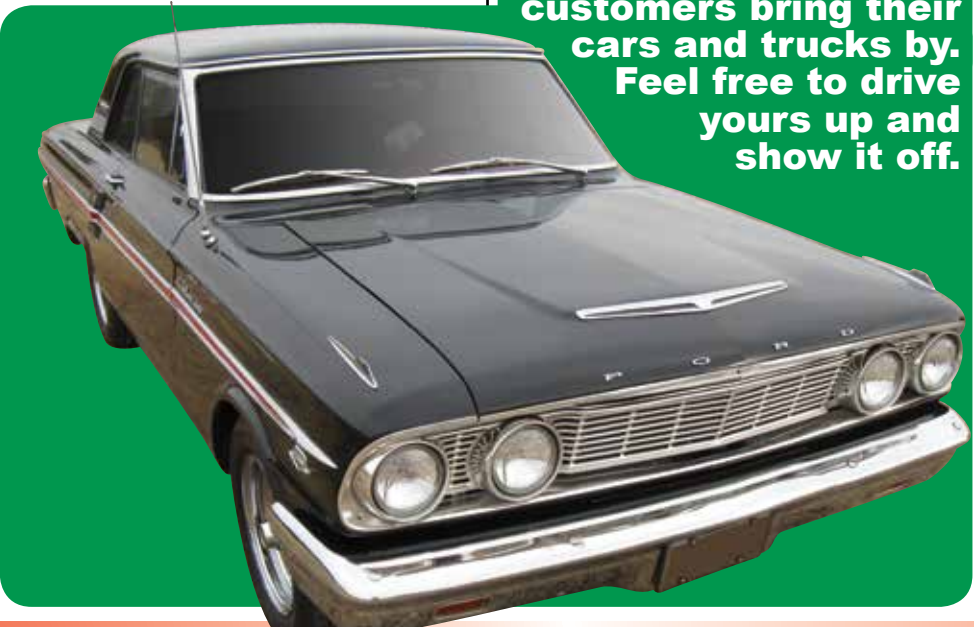

**Check out our website for information, and up to date pricing!**

# 1962-72 Fairlane

• Interior Decals • Interior Decals • Interior Decals •

Decals



DF-200-370



DL-200-266

## 1966-67

Ford® sill plate metal decal - black

DF-200-370 each . . . . . 9.00

Mercury® seat belt retractor instruction tag

DL-200-266 each . . . . . 0.00



## 1966-68

Comet safety precaution decal

DL-200-268 each . . . . . 4.50



## 1966-69

Fairlane and Ranchero sun visor safety decal

DF-200-665 each . . . . . 8.95



DF-200-1090



DF-200-711

## 1966-70

Fairlane and Torino convertible top latch Utica decal

DF-200-1090 each . . . . . 4.95

Ford® Convertible top caution decal

DF-200-711 each . . . . . 8.95



**Our standard ground service is shipped by FedEx. If you desire another carrier, let us know when you place your order, and we'll get you the details.**



## 1966-72

Fairlane sun visor starting instruction sleeve

DF-200-170 each . . . . . 8.95

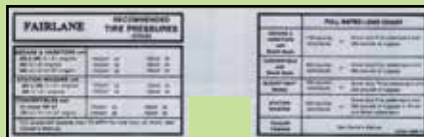

DF-200-672

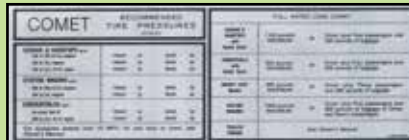

DL-200-491

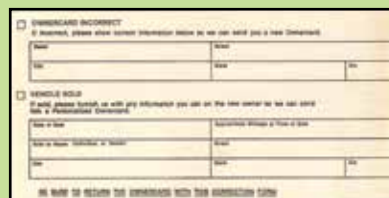

DF-200-701

## 1967

Fairlane tire pressure decal

DF-200-672 each . . . . . 9.95

Ford® personalized warranty card instruction sheet

DF-200-701 each . . . . . 8.95

Fairlane and Ranchero new car window price sticker

DF-200-1178 each . . . . . 9.95

Fairlane and Ranchero factory build sheet

DF-200-1384 each . . . . . 9.95

Comet tire pressure decal

DL-200-491 each . . . . . 0.00

Cyclone GT dash decal for emblem

DL-200-816 each . . . . . 0.00

Mercury® new vehicle assembly build sheet

DL-200-765 each . . . . . 0.00



## 1967-68

Ford® 3-speed transmission instruction tag

DF-200-649 each . . . . . 8.95

Mercury® 3 speed transmission instruction tag

DL-200-680 each . . . . . 0.00



## 1967-69

Ford® warranty owner's change report sheet

DF-200-1087 each . . . . . 8.95

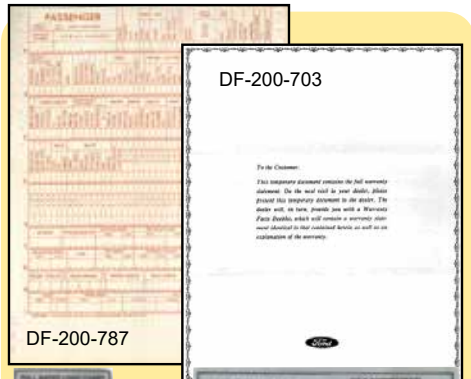

DF-200-787

DF-200-703

DF-200-438

## 1968

Fairlane tire pressure decal - 10½"

DF-200-1311 each . . . . . 9.95

Fairlane tire pressure decal - 7¾"

DF-200-438 each . . . . . 9.95

Fairlane and Ranchero new vehicle warranty sheet

DF-200-703 each . . . . . 8.95

Fairlane and Ranchero new car window price sticker

DF-200-265 each . . . . . 9.95

Fairlane and Ranchero factory build sheet

DF-200-787 each . . . . . 9.95

Mercury® new car window price sticker

DL-200-776 each . . . . . 0.00

Mercury® new vehicle assembly build sheet

DL-200-691 each . . . . . 0.00

**Check out our website for information, and up to date pricing!**

# 1962-72 Fairlane

• Interior Decals • Interior Decals • Interior Decals •

DF-200-1086



## 1968-69

All Ford® VIN boarder decal

**DF-200-1570 each . . . . . 11.95**

Ford® 1968 to early 1969 personalized warranty instruction sheet

**DF-200-1086 each . . . . . 8.95**

Ford® Safety Act decal

**DF-200-694 each . . . . . 2.95**



DF-200-695

## 1968-72

Fairlane, Torino and Ranchero recall postcard

**DF-200-695 each . . . . . 8.95**

Ford® all seat belt metal insert

**DF-200-1523 each . . . . . 11.95**

Torino and Ranchero blue sill plate decal

**DF-200-709 each . . . . . 9.95**

Mercury® all seat belt metal insert

**DL-200-871 each . . . . . 0.00**

**I want you to check out our website for easy shopping and current prices for anything you may need. Don't want to order on-line? Just give us a call and we'll be happy to help!**

DF-200-1088



DF-200-327



DF-200-1085

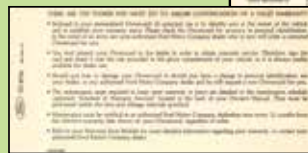

DF-200-1058



## 1969

Fairlane and Torino tire pressure decal

**DF-200-1058 each . . . . . 7.95**

Ford® for late 1969 personalized warranty instruction sheet

**DF-200-1085 each . . . . . 8.95**

Fairlane, Torino and Ranchero warranty sheet

**DF-200-1088 each . . . . . 8.95**

Fairlane, Torino and Ranchero new car window price sticker

**DF-200-327 each . . . . . 9.95**

Fairlane and Ranchero factory build sheet

**DF-200-786 each . . . . . 9.95**

Ford® final inspection traveler sheet

**DF-200-978 each . . . . . 9.95**

Mercury® new vehicle assembly build sheet

**DL-200-690 each . . . . . 0.00**

Mercury® final inspection traveler sheet

**DL-200-522 each . . . . . 0.00**



## 1969-71

Mercury® rim blow steering wheel instruction tag

**DL-200-594 each . . . . . 8.95**

DL-200-415

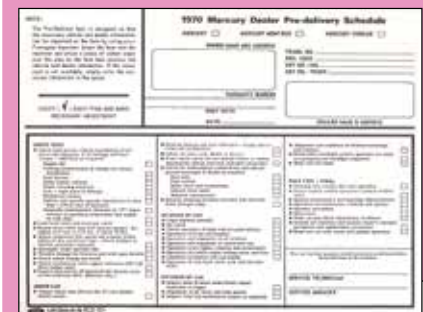

DF-200-726



DF-200-788



## 1970

Torino tire pressure decal

**DF-200-788 each . . . . . 9.95**

Torino and Ranchero and Mercury® ignition lock instruction sleeve

**DF-200-726 each . . . . . 9.95**

All Ford® extended warranty card

**DF-200-1465 each . . . . . 9.95**

Torino and Ranchero new car window price sticker

**DF-200-442 each . . . . . 9.95**

Torino and Ranchero factory build sheet

**DF-200-785 each . . . . . 9.95**

Mercury® new vehicle assembly build sheet

**DL-200-689 each . . . . . 0.00**

Mercury® dealer pre-delivery sheet

**DL-200-415 each . . . . . 0.00**

**“There is joy in work. There is no happiness except in the realization that we have accomplished something.”**  
**- Henry Ford**

**Don't forget to join our e-mail list. We send out e-mail specials, and you don't want to miss out!**

Decals

# 1962-72 Fairlane

• Interior Decals • Interior Decals • Interior Decals •

Decals

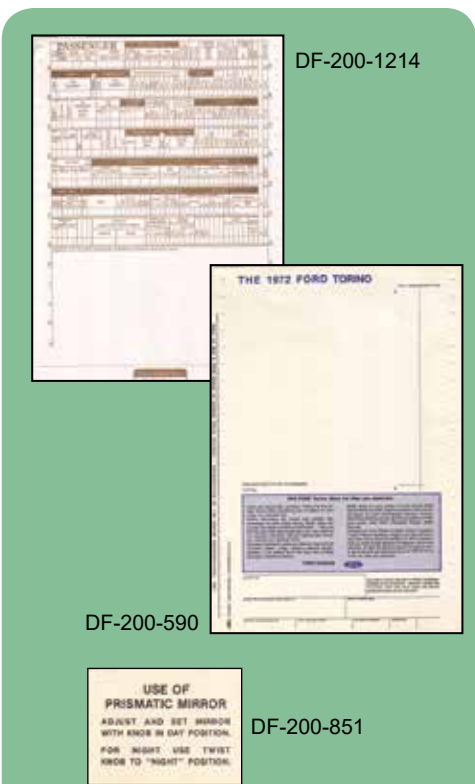
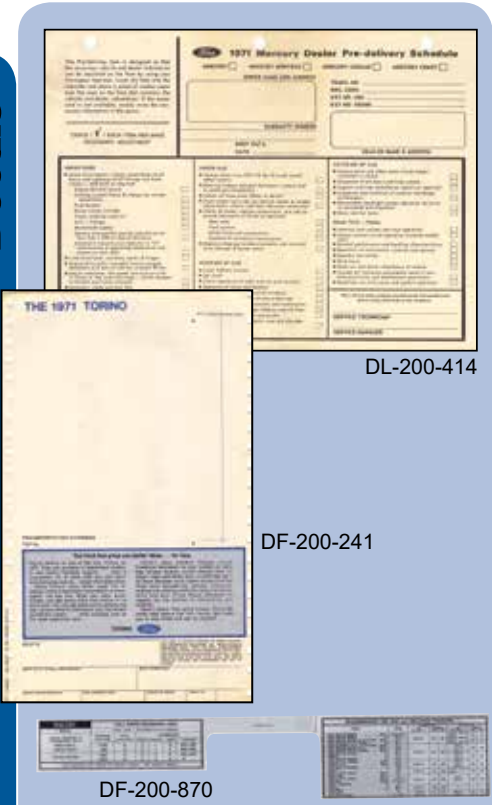

- 1971**
- Torino tire pressure decal
  - DF-200-870 each . . . . . 9.95**
  - Torino and Ranchero new car window price sticker
  - DF-200-241 each . . . . . 9.95**
  - Torino and Ranchero factory build sheet
  - DF-200-1381 each . . . . . 9.95**
  - Mercury® new car window price sticker
  - DL-200-590 each . . . . . 0.00**
  - Mercury® new vehicle assembly build sheet
  - DL-200-764 each . . . . . 0.00**
  - Mercury® dealer pre-delivery sheet
  - DL-200-414 each . . . . . 0.00**

- 1972**
- Torino new car window price sticker
  - DF-200-590 each . . . . . 9.95**
  - Torino factory build sheet
  - DF-200-1214 each . . . . . 9.95**
  - Ranchero tire pressure decal
  - DF-200-710 each . . . . . 5.00**
  - Ranchero new vehicle window price sticker
  - DF-200-590 each . . . . . 9.95**
  - Torino factory new vehicle build sheet
  - DF-200-1214 each . . . . . 9.95**
  - Mercury® new car window price sticker
  - DL-200-591 each . . . . . 0.00**
  - Mercury® new vehicle assembly build sheet
  - DL-200-745 each . . . . . 0.00**
  - Ford® Police Interceptor window decal
  - DF-200-1184 each . . . . . 4.50**
  - Ford® prismatic mirror instruction decal
  - DF-200-851 each . . . . . 8.95**
  - Mercury® Detroit locker glove box decal
  - DL-200-672 each . . . . . 0.00**
  - Ford® 6000 mile/6 month lube sticker
  - DL-200-342 each . . . . . 0.00**

**We accept these MAJOR credit cards.**



*Thanks*

**Obsolete & Classic Auto Parts, Inc.**

8701 South I-35  
Oklahoma City, OK 73149

**Summer Store Hours:**

**Monday - Friday**  
8 a.m. thru 6 p.m.  
**Saturday**  
8 a.m. thru 12 p.m.

**Winter Store Hours:**

**Monday - Friday**  
8 a.m. thru 5 p.m.  
**Saturday**  
8 a.m. thru 12 p.m.  
(Central Standard Time)

We accept VISA • DISCOVER  
MASTERCARD

check us out at  
[www.classicautoparts.com](http://www.classicautoparts.com)

**NEXT DAY AIR**  
service available  
on ALL orders!



# 1962-72 Fairlane

• Trunk Decals • Trunk Decals • Trunk Decals • Trunk Decals •

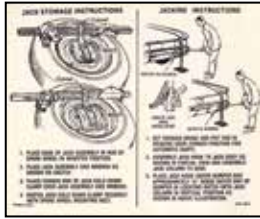

**1962-63**  
Ford® jack instruction decal  
**DF-300-441 each . . . . . 8.95**



**1962-72**  
Ford® and Mercury® production paint OK (P) decal - red  
**DF-300-1157 each . . . . . 4.00**

**1963-65**  
Fairlane tire pressure decal  
**DF-300-292 each . . . . . 4.95**

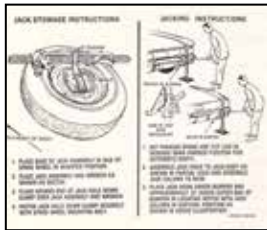

**1964-65**  
Ford® jack instruction decal - regular wheel  
**DF-300-646 each . . . . . 8.95**

**1966**  
Fairlane tire pressure decal  
**DF-300-743 each . . . . . 5.95**

DF-300-456

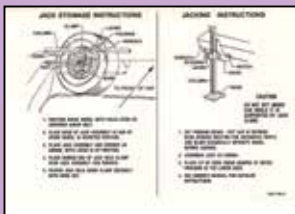

**1966-67**  
Ford® and Mercury® jack instruction decal - styled wheel  
**DF-300-440 each . . . . . 8.95**  
Ford® and Mercury® jack instruction decal - regular wheel  
**DF-300-456 each . . . . . 8.95**  
Ford® and Mercury® jack instruction decal - Station Wagon  
**DF-300-457 each . . . . . 8.95**  
Ford® jack instruction decal - Convertible, regular wheel  
**DF-300-730 each . . . . . 8.95**

**1967**  
Fairlane tire pressure decal  
**DF-300-672 each . . . . . 5.95**

**1968**  
Fairlane tire pressure  
**DF-300-438 each . . . . . 5.95**

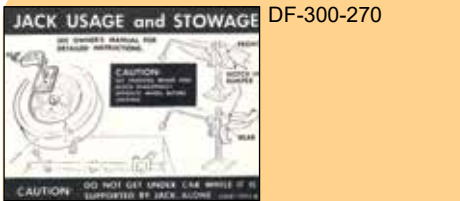

DF-300-307

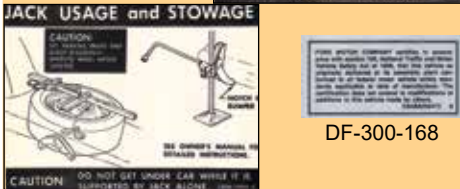

DF-300-168

DF-300-299

**1968-69**  
Ford® jack instruction decal - Fastback, regular wheel  
**DF-300-270 each . . . . . 8.95**  
Ford® jack instruction decal - Fastback, styled wheels  
**DF-300-307 each . . . . . 8.95**  
Ford® jack instruction decal - Sedan and Convertible, regular wheel  
**DF-300-299 each . . . . . 8.95**  
Ford® jack instruction decal - Sedan and Convertible, styled wheels  
**DF-300-312 each . . . . . 8.95**  
Ford® Safety Act certification decal  
**DF-300-168 each . . . . . 8.95**  
Ford® jack instruction - Ranchero, regular wheel  
**DF-300-397 each . . . . . 4.50**  
Ford® Safety Act certification decal  
**DF-300-694 each . . . . . 4.00**  
Mercury® Safety Act decal  
**DL-300-96 each . . . . . 0.00**

**1969**  
Fairlane tire pressure  
**DF-300-1058 each . . . . . 9.95**

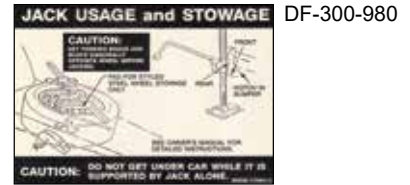

**1970**  
Ford® jack instruction decal - Convertible, styled wheels  
**DF-300-980 each . . . . . 8.95**  
Ford® jack instruction - Ranchero, regular wheel  
**DF-300-823 each . . . . . 4.50**  
Fairlane tire pressure decal  
**DF-300-788 each . . . . . 5.95**

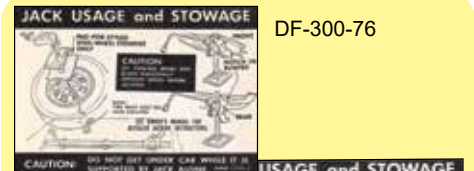

DF-300-76

DF-300-636

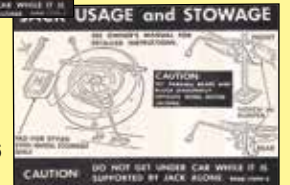

**1970-71**  
Ford® jack instruction decal - Fastback, Hardtop, and Sedan except 429 4 speed, regular wheels  
**DF-300-398 each . . . . . 8.95**  
Ford® jack instruction decal - Fastback, Hardtop, and Sedan except 429 4 speed, styled wheels  
**DF-300-446 each . . . . . 8.95**  
Ford® jack instruction decal - all 429 4 speed, regular wheels  
**DF-300-636 each . . . . . 8.95**  
Mercury® jack instruction decal, styled steel wheel  
**DL-300-76 each . . . . . 0.00**  
Mercury® jack instruction - Convertible, regular wheels  
**DL-300-630 each . . . . . 0.00**

**1-800-654-3247**  
**Call Us for**  
**All-American**  
**Deals**

*If everyone is moving forward together, then success takes care of itself.*  
Henry Ford

Decals

# 1962-72 Fairlane

## • Trunk Decals •

## • Exterior & Chassis Decals •



- 1971**  
 Ford® jack instruction decal - Convertible, regular wheels  
**DF-300-542 each . . . . . 8.95**  
 Ranchero jack instruction decal  
**DF-300-935 each . . . . . 4.50**



- 1971-72**  
 Mercury® jack instruction decal  
**DL-300-140 each . . . . . 8.95**



- DF-300-471**
- 1972**  
 Fairlane and Montego jack instruction decal - all  
**DF-300-471 each . . . . . 8.95**  
 Ford® jack instruction decal  
**DF-300-1224 each . . . . . 4.50**  
 Ford® jack instruction decal  
**DF-300-541 each . . . . . 4.50**  
 Montego jack instruction decal  
**DL-300-178 each . . . . . 0.00**

**Check out our website for information, and up to date pricing!**



- 1969**  
 Ford® Talladega gas cap decal  
**DF-500-593 each . . . . . 0.00**



**COBRA**

- 1970**  
 Torino cobra snake decal - right hand or deck lid  
**DF-500-521 each . . . . . 0.00**  
 Torino cobra snake decal - left hand  
**DF-500-522 each . . . . . 0.00**



**Cobra**

- 1971**  
 Torino cobra snake decal - blue  
**DF-500-537 pair . . . . . 0.00**  
 Torino cobra snake decal - brown  
**DF-500-538 pair . . . . . 0.00**  
 Torino cobra snake decal - green  
**DF-500-539 pair . . . . . 0.00**  
 Torino cobra snake decal - red  
**DF-500-540 pair . . . . . 0.00**

**We accept these MAJOR credit cards.**



UNLEADED GASOLINE ONLY

- Unleaded gasoline only 5" straight - white  
**DZ-500-8 each . . . . . 8.95**

UNLEADED GASOLINE ONLY

- Unleaded gasoline only 5" straight - black  
**DZ-500-9 each . . . . . 8.95**

UNLEADED GASOLINE ONLY

- Unleaded gasoline only 5" straight - black/white  
**DZ-500-13 each . . . . . 8.95**

UNLEADED GASOLINE ONLY

- Unleaded gasoline only 4" straight - black/silver  
**DZ-500-12 each . . . . . 8.95**

UNLEADED FUEL ONLY

- Unleaded fuel only 3" curved - white  
**DZ-500-10 each . . . . . 8.95**

UNLEADED FUEL ONLY

- Unleaded fuel only 3" curved - black  
**DZ-500-11 each . . . . . 8.95**



- Ford® 2" wheel center decal with Ford® oval  
**DF-500-1447 each . . . . . 0.00**



- Ford® 1965-70 Coil spring shipping tag  
**DF-500-1516 each . . . . . 0.00**  
 Mercury® Coil spring shipping tag  
**DL-500-589 each . . . . . 9.95**



# 1962-72 Fairlane

## • Miscellaneous Decals • Miscellaneous Decals •



- 3½" Ford® oval decal - blue on white  
**DF-600-361 each** ..... 0.00
- 3½" Ford® oval decal - blue on clear  
**DF-600-1388 each** ..... 0.00
- 6½" Ford® oval decal - blue on white  
**DF-600-362 each** ..... 0.00
- 6½" Ford® oval decal - blue on clear  
**DF-600-1389 each** ..... 0.00
- 9½" Ford® oval decal - blue on white  
**DF-600-363 each** ..... 0.00
- 9½" Ford® oval decal - blue on clear  
**DF-600-1390 each** ..... 0.00
- 17" Ford® oval decal - blue on white  
**DF-600-364 each** ..... 0.00
- 17" Ford® oval decal - blue on clear  
**DF-600-1391 each** ..... 0.00



- 3" Ford® genuine parts decal  
**DF-600-531 each** ..... 0.00



DZ-600-114

- Muscle power inside window decal  
**DZ-600-113 each** ..... 9.95
- Muscle power exterior decal  
**DZ-600-114 each** ..... 9.95



DZ-600-116

- 5" Ford® drag team decal  
**DZ-600-115 each** ..... 9.95
- 8" Ford® drag team decal  
**DZ-600-116 each** ..... 9.95



- Cobra window decal - 5 ½ x 4 ½"  
**DF-600-822 each** ..... 0.00
- Cobra-Jet window decal - 5 x 4 ½"  
**DF-600-393 each** ..... 0.00



DZ-600-122

- 1½" x 2½" Ford® Autolite decal  
**DZ-600-120 each** ..... 9.95
- 5" Autolite GT40 decal  
**DZ-600-122 each** ..... 9.95
- 8" Autolite GT40 decal  
**DZ-600-123 each** ..... 9.95

DZ-600-04



- 4" Autolite spark plug circle decal  
**DZ-600-05 each** ..... 9.00
- 6½" Autolite spark plug circle decal  
**DZ-600-04 each** ..... 10.00



- 6" Motorcraft GT40 decal  
**DZ-600-121 each** ..... 9.95

Check out our Swap Meet Schedule to see when we will be in your area. Maybe even save some on shipping. Call one of the guys for more information!



- Lady Luck Decal - 6"  
**DZ-600-175 each** ..... 11.95



DZ-600-273

- Ford® Power Punch battery decal  
**DZ-600-273 each** ..... 9.95
- Ford® Power Battery oval decal  
**DZ-600-275 each** ..... 9.95



Classic Auto Parts has been serving your car and truck needs since 1974!  
We appreciate our customers!

**1-800-654-3247**  
**Call Us for**  
**All-American**  
*Deals*

Decals

# 1962-72 Fairlane



## Rear Wheel Backing Plate Gasket

1962-69 Fairlane - 1962-63 Meteor - all  
1966-68 Comet - all

2<sup>5</sup>/<sub>16</sub>" ID  
(Stock # P01-105)

Price Reduced!

OEM # A8AZ-1001-A each. . . . . .95



## Rear Brake Carrier Plate Gasket

1963-70 Fairlane  
1963 Meteor

1966-70 Comet - before 9-30-69

2<sup>7</sup>/<sub>16</sub>" ID  
(Stock # P01-105-015)

Price Reduced!

OEM # C1AZ-1001-A each. . . . . .95



## 14" Styled Steel Wheel

Want to get your car as factory as possible? This is a styled steel wheel with black outer rims, argent depressions & chrome trim. The stainless trim rings are optional and sold separately.

1966 Fairlane and Comet - 14 x 5"  
1967 Comet - 200 and 289 - 14 x 5"

Backspacing 3.75 - Bolt Pattern 5 on 4<sup>1</sup>/<sub>2</sub>  
(Stock # B01-115-010)

OEM # C6OZ-1007-A each. . . . . 181.00

1967 Fairlane and Comet - 14 x 5<sup>1</sup>/<sub>2</sub>"  
(Stock # B01-115-020)

OEM # C7OZ-1007-B each. . . . . 181.00



(A)

## Styled Steel GT Rallye Rims

Beautiful precise assembly that ensures a true and balanceable rim, triple chrome plating. Perfect OEM reproductions.

1968-69 Fairlane - 14 x 6" - with chrome center

(Stock # B01-115-030) - black rim Price Reduced!  
OEM # C8OZ-1007-A each. . . . . 259.95

(Stock # B01-115-031) - chrome rim Price Reduced!  
OEM # C8OZ-1007-B each. (A). 259.95

1970-72 Torino - 14 X 7" All Chrome  
(Stock # B01-115-032)

OEM # C8OZ-1007-C each. . . . . 267.95



## Front and Rear Hub Bolt Nut

1/2" x 20 open

1962-69 Fairlane

1962-63 Meteor

(Stock # V01-120-025)

OEM # B-1012 each. . . . . .95



## Chrome Lug Nut

For style steel wheels.

1965-69 Fairlane

1966-70 Comet

(Stock # P01-120-030)

OEM # C5ZZ-1012-B each . . . . . 2.95



## Lug Nut Cupped Washer

Special washer, tapered like a cone fits in worn wheel holes. This stops paint from chipping when tightening lug nuts. Solves wheel bolt hole wear. Fits under the lug nut. Stainless steel.

1962-70 Fairlane

1962-71 Mercury®

(Stock # V01-125)

OEM # B-1013 each. . . . . .95



## Styled Steel Wheel Accent Set

Our ABS plastic accents will bring those argent styled steel wheels to life. Features include a bright chrome finish and simple snap-in installation. These were a rare option offered by Ford®. These wheel accents really dress up argent or body color painted rims! 50 piece set does four wheels.

1968-69 Fairlane

(Stock # B01-190-100) - set of 50

OEM # C9ZZ-1A079-A set . . . . . 132.95



(A)

(B)

## Disc Brake Rotor

1967 Fairlane and Comet

(Stock # P01-220-010) - 1 piece design

OEM # C5ZZ-1102-B each . (A) . . 85.95

1968-69 Fairlane and Comet

(Stock # B01-220-025) - 1 piece design

OEM # C8OZ-1102-A each. (B). 105.95

1970 Fairlane

1970-71 Comet or Montego

(Stock # B01-220-055) - 1 piece design

OEM # D0OZ-1102-B each . . . . . 79.95

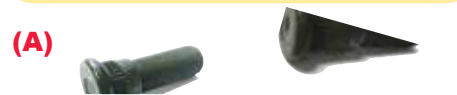

(A)

(B)

## Wheel Hub Bolt

Front or rear

1962-64 Fairlane - rear wheels

1962-63 Meteor

1965-70 Comet and Montego - rear drum brakes

(Stock # P01-240-040) - 1/2" x 20 x 1 5/8" Price Reduced!

OEM # A9AZ-1107-B each. . (A) . . 3.95

1962-70 Fairlane

(Stock # P01-240-050) - 1/2" x 20 x 1 1/16" (B)

OEM # C3AZ-1107-A each. . . . . 4.95

1965-70 Fairlane - front drum, except full cast drums - 1/2-20 x 1 1/2

(Stock # P01-240-047)

OEM # C1AZ-1107-A each. . . . . 6.95



# 1962-72 Fairlane



## Wheel Stud

Has knurl at head.

1968 Fairlane - disc brakes  
(Stock # B01-240-150) - 1/2 - 20 x 1 13/32"

**OEM # C8OZ-1107-A each . . . . . 5.95**



## Drum Brake Hub

This part was originally part of the hub and drum assembly - 5 lug

1963-65 Fairlane - 8 cylinder  
(Stock # P01-240-075)

**OEM # C5ZZ-1107-HUB each . . 119.95**



## Front Brake Drum

1962-63 Meteor - Station Wagon  
1962-70 Fairlane  
1966-70 Comet

1968-71 Torino, Montego and Cyclone  
(Stock # B01-300-090) - 10 x 2 3/4" **Price Reduced!**

**OEM # C6OZ-1125-A each . . . . . 91.95**

1962-65 Fairlane  
(Stock # B01-300-075) - 10 x 2 1/4"

**OEM # C3OZ-1125-D each . . . . 115.95**

1971-72 Comet  
(Stock # X01-220-015) - 9 x 2 1/2" **(A)**

**OEM # C6DZ-1102-B each . . . . . 64.95**



**(A)**

## Rear Brake Drum

1962-70 Fairlane  
1962-63 Meteor - Station Wagon  
1966-70 Comet  
1967-70 Comet - disc brakes  
1966-67 Cyclone - disc brakes  
1968-70 Montego - disc brakes  
1968-71 Torino

1968-71 Montego and Cyclone

**10" composite non-finned drum**  
(Stock # B01-305-075)

**OEM # C2OZ-1126-B each . . . . . 56.95**

1963-67 Fairlane

1963 Meteor - Station Wagon  
(Stock # B01-305-084) - 10 x 2 1/2" non-flared

**OEM # C3OZ-1126-A each . . . . . 74.95**

1963 Meteor - except Station Wagon

1966-70 Comet

1966-67 Cyclone - disc brakes

1967-70 Comet - disc brakes

1968-71 Montego - disc brakes

1968-71 Cyclone and Montego

(Stock # B01-305-085) - 10 x 1 3/4"

**OEM # C3OZ-1126-B each . . . . . 98.95**

1966 Comet

(Stock # X01-305-065) - 9 x 2 1/4" **Price Reduced!**

**OEM # C0DZ-1126-B each . . . . . 49.95**



**(A)**



**(B)**

## Wire Wheel Spinner

Wire wheel chrome spinner for 13 and 14" wire wheel covers. Chrome plated and die cast as original.

1963-65 Fairlane and Torino

(Stock # B01-535-020) **Price Reduced!**

**OEM # C3OZ-1A363-A each . . . . 47.95**

## Wheel Spinner Plastic Insert

Red, blue and gold

1963-65 Fairlane

(Stock # X01-355-010) **(B)**

**OEM # C3DZ-1141-A each . . . . . 35.95**



## Styled Steel Wheel Center Cap

With the Crest logo, red background, white and blue rest as original.

1965-67 Fairlane

(Stock # B03-315-263)

**OEM # C6OZ-1130-SS each . . . . 43.95**

**Price Reduced!**

**(A)**



**(B)**

## Styled Steel Hub Cap

Heavy gauge polished stainless cap with or without the GT emblem installed.

1969 Fairlane - except Rio Grande **(A)**

(Stock # B01-315-280) - 7.5" diameter

**OEM # C8OZ-1130-C each . . . . . 39.95**

With a plain center.

1968-70 Fairlane - except Rio Grande

1969-71 Cyclone and Montego - Cyclone spoiler

(Stock # B01-315-285) - 7.5" diameter **(B)**

**OEM # C8OZ-1130-G each . . . . . 33.95**



## Hub Cap Center Emblem

For 7 1/2" hub cap, with GT emblem.

1968-69 Fairlane

(Stock # B01-315-290)

**OEM # C8OZ-1130-GTE each . . . 19.95**



## Hub Cap Center Emblem

Magnum 500 center cap. Features red Ford® crest. Push-in style for easy installation. Can be used with or without trim rings.

(Stock # B01-315-300)

**OEM # D0OZ-1130-F each . . . . . 41.95**

**If you think you can do a thing or think you can't do a thing, you're right.**

~Henry Ford

**1-800-654-3247**

**Call Us for**

**All-American**

**Deals**

# 1962-72 Fairlane

Wheel Parts



## Front Wheel Hub Dust Cap

1<sup>23</sup>/<sub>32</sub>" OD - 5 lug wheel

1962-69 Fairlane/Torino

1966-70 Comet and Montego - all

1968-69 Comet and Montego - disc brakes

(Stock # P01-320-015)

Price Reduced!

OEM # B5A-1131-A each . . . . . 2.95



## Wire Wheel Center Emblems

For 13 and 14" wire wheel hub caps.

1963-65 Fairlane

(Stock # X01-355-010)

(A)

Price Reduced!

OEM # C3DZ-1141-A each . . . . . 35.95

1964 Fairlane - Sports Coupe

(Stock # B01-355-020)

(B)

OEM # C4OZ-1141-S each . . . . . 49.95



## Hubcap Center Emblem

Adhesive emblem - Chrome plated with blue background and black line symbol. This is a really nice piece.

1967-68 Fairlane/Torino

(Stock # P01-355-025)

OEM # C5AZ-1141-A each . . . . . 23.95



## Wheel Center Emblem

Red emblem with black logo designed for the simulated mag wheels.

1970-71 Fairlane/Torino

(Stock # B01-355-125)

OEM # D0OZ-1141-A each . . . . . 49.95



## Rear Wheel Grease Seal

1962-67 Fairlane

1968 Comet and Montego

(Stock # P01-385-015) - 1<sup>3</sup>/<sub>8</sub>" ID x 2<sup>3</sup>/<sub>8</sub>" OD

OEM # B7A-1177-B each . . . . . 4.95

1962-67 Fairlane

1964-72 Fairlane - with 28 spline axle

(Stock # P01-385-035) - 1<sup>3</sup>/<sub>4</sub>" ID

OEM # C2OW-1177-A each . . . . . 13.95

1965-67 Fairlane - 427

1969-71 Fairlane - with 31 spline axle

1967-68 Comet and Montego - 8 cylinder

1969-70 Comet and Montego - 31 spline axle shaft

(Stock # M01-385-040) - 1<sup>1</sup>/<sub>2</sub>" ID

OEM # C7OZ-1177-A each . . . . . 9.95



## Rear Wheel Bearing Retainer

1962-69 Fairlane

1966-70 Comet

(Stock # P01-390-005) - 1<sup>3</sup>/<sub>8</sub>" ID x 2" OD

OEM # 8A-1180 each . . . . . 8.95

1962-69 Fairlane

(Stock # M01-390-010) - 1<sup>7</sup>/<sub>32</sub>" ID x 2<sup>3</sup>/<sub>8</sub>" OD

OEM # 8M-1180 each . . . . . 9.95



## Front Wheel Grease Seal

1962-70 Fairlane - drum brakes

1966-69 Comet and Montego - drum and disc brakes

(Stock # P01-400-050) - 2<sup>1</sup>/<sub>2</sub>" OD (A)

OEM # B5A-1190-A each . . . . . 1.95

1967-69 Comet and Montego - disc brakes

1968-70 Fairlane - disc brakes

1970 Comet and Montego - all

(Stock # P01-400-175) - 2<sup>3</sup>/<sub>4</sub>" OD

OEM # C8AZ-1190-A each . . . . . 1.95



## Front Spindle Nut to Outer Bearing Washer

1962-69 Fairlane

(Stock # P01-410-015) - 1<sup>2</sup>/<sub>32</sub>" OD

OEM # C2AZ-1195-A each . . . . . 2.95



## Front Wheel Inner Bearing (A)

1962-69 Fairlane - all

1966-70 Comet - 6 cylinder

(Stock # P01-425-030) - 1<sup>1</sup>/<sub>4</sub>" ID

OEM # B5A-1201-A each . . . . . 6.95

1965-72 Fairlane

1966-70 Comet

1968-70 Montego

(Stock # P01-425-055) - 1<sup>3</sup>/<sub>8</sub>" ID

OEM # D0AZ-1201-A each . . . . . 6.95

## Front Wheel Inner Bearing Cup (B)

1962-69 Fairlane

1966-69 Comet and Montego

(Stock # P01-430-035) - 1<sup>1</sup>/<sub>4</sub>" ID

OEM # B5A-1202-A each . . . . . 3.95

1965-72 Fairlane

1966-70 Comet

1968-70 Montego

(Stock # P01-430-060) - 1<sup>3</sup>/<sub>8</sub>" ID

OEM # D0AZ-1202-A each . . . . . 3.95



## Wheel Trim Ring

Styled Steel Stainless Ring - fits on the 14" OEM or reproduction wheels.

1966-72 All

(Stock # P01-435-005)

OEM # C6ZZ-1210-AR each . . . . . 37.95

Check out our Swap Meet Schedule to see when we will be in your area. Maybe even save some on shipping. Call one of the guys for more information!

# 1962-72 Fairlane



## Front Wheel Outer Bearing (A)

1962-69 Fairlane  
1966-69 Comet and Montego **Price Reduced!**  
(Stock # P01-440-035) - 3/4" ID

**OEM # B5A-1216-A each. . . . . 5.95**

1965-70 Fairlane  
1966-70 Comet  
(Stock # P01-440-065) - 7/8" ID

**OEM # D0AZ-1216-A each . . . . . 6.95**

## Front Wheel Outer Race (B)

1962-69 Fairlane  
1966-70 Comet - 6 and 8 cylinder  
(Stock # P01-445-025) - 3/4" ID

**OEM # B5A-1217-A each. . . . . 2.95**

1965-70 Fairlane  
1966-70 Comet  
(Stock # P01-445-050) - 7/8" ID

**OEM # D0AZ-1217-A each . . . . . 2.95**



## Rear Wheel Bearing

1962-71 Fairlane - all  
1966-70 Comet and Montego - all  
(Stock # P01-450-02) - 2 3/16" OD

**OEM # B7AZ-1225 each . . . . . 22.95**



## Spare Wheel Carrier Bolt

May be cut down if necessary

1962-70 Fairlane  
1966-67 Comet  
(Stock # B01-665-025) - 3/8" x 9 3/16"

**OEM # C6OZ-1448-A each. . . . . 5.95**

"J" hook  
1966 Fairlane - except Station Wagon and Convertible

1966 Comet - Sedan and Hardtop  
1967 Comet - except Station Wagon  
(Stock # P01-665-005) - 3/8" -16 x 7 7/8" **(A)**

**OEM # B5A-1448-B each. . . . . 6.95**



## Wing Bolt with Washer

1962 Fairlane - all  
1963-65 Fairlane - except Station Wagon  
(Stock # P01-665-010)

**OEM # B7A-1448-A each. . . . . 21.95**



## Spare Wheel Clamp

Hold down wing nut with rubber coated ends.

1966-67 Fairlane - except Ranchero and Station Wagon

1963-66 Fairlane - Station Wagon  
1967-71 Ranchero  
(Stock # P01-690) - 3/8"-16 **(A)**

**OEM # BA-1457-A each. . . . . 5.95**

1963-64 Ranch Wagon or Squire  
1963-69 Fairlane

1966-68 Comet **Price Reduced!**  
1968-69 Torino  
(Stock # P01-700-005) - 3/8"-16

**OEM # B9AZ-1462-A each. . . . . 2.95**

1968-70 Fairlane  
1968-71 Comet and Montego **Price Reduced!**  
(Stock # P01-700-010) - 1/2"-13

**OEM # C8AZ-1462-A each. . . . . 2.50**



**Please allow 7-14 days  
for Special Orders!**

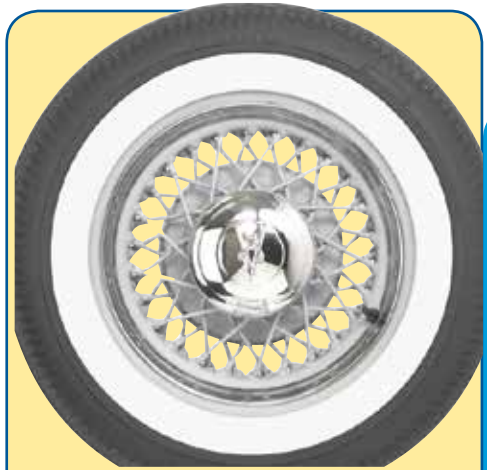

## Whitewall Tire

**Special Order ONLY!** Available in the following sizes and brands:

- 695 x 14 BF Goodrich
- 700 x 14 BF Goodrich
- 735 x 14 BF Goodrich
- 750 x 14 BF Goodrich
- E78 x 14 Commander
- F70 x 14 Firestone
- F78 x 14 Firestone
- F750 x 14 Firestone
- G78 x 14 Firestone
- G70 x 14 Firestone

(Stock # B01-750-110)  
**OEM # C2OZ-1500-WSP0 each. . . . . 0.00**



## Red Line Tires

**Special Order ONLY!** Available in the following sizes and brands:

- 695 x 14 Firestone
- 750 x 14 BF Goodrich
- 775 x 14 BF Goodrich
- E70 x 14 Firestone
- F70 x 14 Firestone
- G78 x 14 Firestone
- G70 x 14 Firestone

(Stock # B01-750-115)  
**OEM # C3OZ-1500-RSPO each . . . 224.95**



# 1962-72 Fairlane

Wheel Parts



### Blackwall Tires

**Special Order ONLY!** Available in the following sizes and brands:

- 695 x 14 BF Goodrich
- 700 x 14 BF Goodrich
- 735 x 14 BF Goodrich
- 750 x 14 BF Goodrich
- 775 x 14 BF Goodrich
- E78 x 14 Commander
- E70 x 14 Firestone
- F70 x 14 Firestone
- F78 x 14 Firestone
- F750 x 14 Firestone
- G78 x 14 Firestone
- G70 x 14 Firestone
- 695 x 14 Firestone

(Stock # B01-750-120)  
**OEM # C4OZ-1500-BSPO each . . . . . 0.00**



### Crown Tire Valve Caps

A perfect nostalgic reproduction.

Gold - (Stock # V01-760-005) - set of 5

**OEM # B-1503-GVC set . . . . . 8.95**

Red - (Stock # V01-760-040) - set of 5

**OEM # B-1503-RVC set . . . . . 8.95**



### Tire Valve Stem Covers

Precision machined with Ford® script encased on top of each one. Complete with buna o-rings for proper sealing.

(Stock # V01-760-045) - set of 5 **Price Reduced!**

**OEM # B-1503-S5429 set . . . . . 11.95**



### Tire Valve Stem Extension

Screws on to the valve stem to extend through full wheel covers.

1960-72 Falcon

1966-70 Comet

(Stock # P01-785) - 1/4" long

**OEM # B7AZ-1705-A each. . . . . 1.95**

## Obsolete & Classic Auto Parts, Inc.

8701 South I-35

Oklahoma City, OK 73149

### Summer Store Hours:

Monday - Friday  
8 a.m. thru 6 p.m.

Saturday  
8 a.m. thru 12 p.m.

### Winter Store Hours:

Monday - Friday  
8 a.m. thru 5 p.m.

Saturday  
8 a.m. thru 12 p.m.

(Central Standard Time)

Please allow 7-14 days for Special Orders!



We love when our customers bring their cars and trucks by. Feel free to drive yours up and show it off.

# 1962-72 Fairlane

## Front Brake Kits

Master Power Brakes disc brake kits bolt to your stock or reproduction spindles without modification. All MPB disc brake kits provide perfect caliper alignment for even pad wear and support the calipers as designed by the original manufacturer. Master Power Brakes kits are complete with everything you need and ready to bolt on with common hand tools.



Brake Parts



**Special ORDER**

### Ford® Power Front Disc Brake Kit

For 1964-65 Fairlane and 1964-65 Comet. Must have 15" or larger wheels or 14" disc brake wheels. Bolts to your original 8 cylinder spindles.

Includes: 11¼" vented rotors, calipers and pads, caliper brackets, 7" dual diaphragm power booster, master cylinder, combination valve kit, brake hoses, bearings, seals, dust caps, and all hardware.

**DB1508P each ..... .945.00**

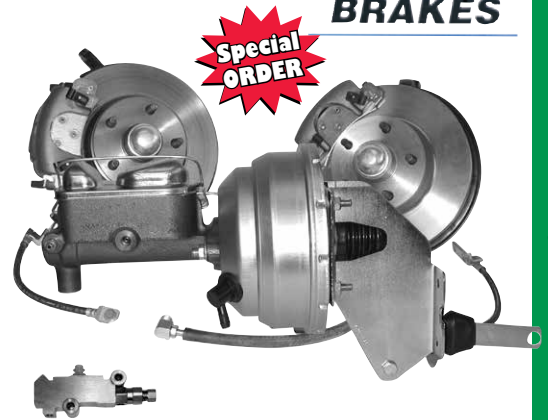

**Special ORDER**

### Ford® Power Front Disc Brake Kit

For 1968-71 Fairlane, Torino and Rancho and Montego. Must have 15" or larger wheels or 14" disc brake wheels. Bolts to your original 8 cylinder spindles.

Includes: 11¼" vented rotors, calipers and pads, caliper brackets, 7" dual diaphragm power booster, master cylinder, combination valve kit, brake hoses, bearings, seals, dust caps, and all hardware.

**DB1509P each ..... .900.00**

### Ford® Power Front Disc Brake Kit

For 1966-67 Fairlane and 1966-67 Comet. Must have 15" or larger wheels or 14" disc brake wheels. Bolts to your original 8 cylinder spindles.

Includes: 11¼" vented rotors, calipers and pads, caliper brackets, 7" dual diaphragm power booster, master cylinder, combination valve kit, brake hoses, bearings, seals, dust caps, and all hardware.

**DB1510P each ..... 900.00**



**Special ORDER**

**Please allow 7-14 days for Special Orders!**

# 1962-72 Fairlane

## Front Brake Kits



Master Power Brakes disc brake kits bolt to your stock or reproduction spindles without modification. All MPB disc brake kits provide perfect caliper alignment for even pad wear and support the calipers as designed by the original manufacturer. Master Power Brakes kits are complete with everything you need and ready to bolt on with common hand tools.

Brake Parts

### Ford® Manual Front Disc Brake Kit

Includes: 11¼" vented rotors, calipers and pads, caliper brackets, master cylinder, combination valve kit, brake hoses, bearings, seals, dust caps, and all hardware.

For 1964-67 Fairlane and 1966-67 Comet. Must have 15" larger wheels or 14" disc brake wheels. Bolts to your original 8 cylinder spindles.

**DB1510M each .....800.00**

For 1968-71 Fairlane, Torino and Rancho and Montego. Must have 15" or larger wheels or 14" disc brake wheels. Bolts to your original 8 cylinder spindles.

**DB1509M each .....800.00**



### Ford® Front Disc Brake Bottom Kit

Includes: 11¼" vented rotors, calipers and pads, caliper brackets, brake hoses, bearings, seals, dust caps, and all hardware.

For 1962-63 Fairlane and 1962-66 Comet. Must have 15" or larger wheels or 14" disc brake wheels. Bolts to original 8 cylinder spindles.

**DB1524B ..... 1045.00**

For 1964-67 Fairlane 1966-67 Rancho and 1966-67 Comet. Must have 15" or larger wheels or 14" disc brake wheels. Bolts to your original 8 cylinder spindles.

**DB1510B each .....700.00**

For 1968-71 Fairlane, Torino and Rancho and Montego. Must have 15" or larger wheels or 14" disc brake wheels. Bolts to your original 8 cylinder spindles.

**DB1509B each .....700.00**

**Please allow 7-14 days for Special Orders!**

# 1962-72 Fairlane

## Rear Brake Kits



Brake Parts



**Special ORDER**

### Ford® Rear Disc Brake Kit With Cross-Drilled/Slotted Rotors - 8" or 9" Small Bearing

Includes: 11 $\frac{1}{8}$ " multi-pattern vented cross-drilled/slotted rotors, calipers with integral parking brake and pads, mounting brackets, brake hoses, parking brake cables, and hardware.

Fits 8" or 9" small bearing Ford® rear ends with 3 $\frac{3}{8}$ " x 2" flange. 5 x 4 $\frac{3}{4}$ " or 5 x 4 $\frac{1}{2}$ " bolt pattern. Must have 15" or larger wheels or 14" disc brake wheels.

**DB1515BHPR** ..... **850.00**

Fits 9" large bearing late Ford® rear ends with 3 $\frac{9}{16}$ " x 2" flange. 5 x 4 $\frac{3}{4}$ " or 5 x 4 $\frac{1}{2}$ " bolt pattern. Must have 15" or larger wheels or 14" disc brake wheels.

**DB1517BHPR** ..... **850.00**

**Please allow  
7-14 days for  
Special Orders!**



### Ford® Rear Disc Brake Kit - 8" or 9" Small Bearing

Includes: 11 $\frac{1}{8}$ " multi-pattern vented rotors, calipers with integral parking brake and pads, mounting brackets, brake hoses, parking brake cables, and hardware.

Fits 8" or 9" small bearing Ford® rear ends with 3 $\frac{3}{8}$ " x 2" flange. 5 x 4 $\frac{3}{4}$ " or 5 x 4 $\frac{1}{2}$ " bolt pattern. Must have 15" or larger wheels or 14" disc brake wheels.

**DB1515BR** ..... **745.00**

Fits 9" large late Ford® rear ends with 3 $\frac{9}{16}$ " x 2" flange. 5 x 4 $\frac{3}{4}$ " or 5 x 4 $\frac{1}{2}$ " bolt pattern. Must have 15" or larger wheels or 14" disc brake wheels.

**DB1517BR** ..... **750.00**

**Special ORDER**

# 1962-72 Fairlane

Brake Parts



## Front Brake Shoes

**10" drum brakes**  
 1966-70 Comet and Cyclone - Station Wagon except 390  
 1967-70 Comet and Cyclone - 351, 390 and 428 Sedan  
 1968-70 Montego - Station Wagon except 390  
 1968-70 Montego - 351, 390 and 428 Sedan  
 1969-70 Montego - 250 and 302 Sedan  
 1969-70 Montego and Cyclone - 250, 302, 351, 390 and 428 Station Wagon  
 1971 Montego - 250, 302, 351 and 429 Station Wagon  
 1971 Montego 351 and 429 Sedan (Stock # B02-1005-120)  
**OEM # C7OZ-2001-B set . . . . . 44.95**  
**10 x 2½"**  
 1966-71 Fairlane - 390, 427, 428, and 390 Station Wagon  
 1967-68 Fairlane and Torino - 390, 427 and 428 Station Wagon and 428 Sedan - disc brakes  
 1968 Torino - 8 cylinder and 390 Station Wagon  
 1969 Fairlane and Torino - 428 and 351, 390, and 429 Station Wagon - disc brakes  
 1969-71 Torino - 302 Sedan and Convertible  
 1972 Torino - 351, 400 and 429 Station Wagon - disc brakes **Price Reduced!**  
**OEM # B9S-2001-R set . . . . . 39.95**  
**10 x 2½"**  
 1969-70 Montego, Cyclone and Comet - 351, 390 and 428 Station Wagon  
 1971 Montego - 351 and 429 Station Wagon (Stock # B02-1005-115) - 4 piece set  
**OEM # C6OZ-2001-A set . . . . . 28.95**

**We have tried to make ordering easy. You can order online with a click of the mouse, or use the order sheets in the back of the catalog. Simply mail or fax over. We'll handle it all from there.**



## Front Disc Pads

1962-63 Meteor  
 1962-65 Fairlane - except Convertible  
 1966-68 Fairlane - except 390, 427, and 428  
 1969-70 Fairlane - except 302 Convertible  
 1966-68 Comet - 6 cylinder and 302  
 1967-68 Cyclone - except 390  
 1968 Montego - all except 390  
 1969-70 Comet  
 1969-70 Cyclone 250 and 302 Sedan  
 1969-71 Montego - 250 and 302 Sedan (Stock # B02-1005-095)  
**OEM # C3OZ-2001-C set . . . . . 37.95**  
 1967 Fairlane - except 427 (Stock # P02-1005-107)  
**OEM # C5ZZ-2001-B set . . . . . 51.95**  
 1968 Comet - except 390, 427 and Convertible  
 1968-71 Montego and Cyclone  
 1969-71 Comet **Price Reduced!**  
 (Stock # B02-1005-145)  
**OEM # D0OZ-2001-A set . . . . . 31.95**

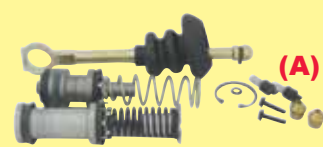

## Master Cylinder Repair Kit

1962 Fairlane - power brakes  
 1962 Meteor - power brakes (Stock # P02-1020-040) - 1" diameter cylinder  
**OEM # C0AZ-2004-C kit . . . . . 19.95**  
 1962-65 Fairlane - manual drum brakes (Stock # P02-1020-017) - 1" cylinder bore  
**OEM # B2A-2004 kit . . . . . 18.95**  
 1962-66 Fairlane - power drum brakes  
 1963 Meteor - power brakes (Stock # P02-1020-055) - 1" cylinder bore  
**OEM # C3AZ-2004-B kit . . . . . 34.95**  
 1966 Fairlane and Comet - manual drum brakes (Stock # P02-1020-065) - 1" cylinder bore  
**OEM # C4AZ-2004-A kit . . . . . 24.95**  
 1967-70 Fairlane - manual drum brakes  
 1967-71 Torino - manual drum brakes  
 1967-71 Comet and Cyclone - manual drum brakes **(A)**  
 (Stock # B02-1020-100) - 1" cylinder bore  
**OEM # C7OZ-2004-D kit . . . . . 65.95**



## Master Cylinder Repair Kit

1967-70 Fairlane - power drum brakes  
 1967-71 Torino - power drum brakes  
 1967-69 Comet and Montego - power drum brakes (Stock # P02-1020-085) - 1½" cylinder bore  
**OEM # C7AZ-2004-B kit . . . . . 27.95**  
 1967-71 Fairlane - manual drum brakes  
 1967-71 Comet and Montego - manual drum brakes (Stock # B02-1020-038) - 1" cylinder bore  
**OEM # C9OZ-2004-A kit . . . . . 29.95**  
 1967-71 Fairlane and Torino - power disc brakes  
 1968-71 Montego - power disc brakes  
 1967-70 Comet - disc brakes  
 1967-71 Cyclone - disc brakes **(A)**  
 (Stock # B02-1020-135) - 1½" cylinder bore  
**OEM # C9OZ-2004-B kit . . . . . 29.95**  
 1972 Torino - manual drum or power disc brakes (Stock # B02-1020-150) - 1" cylinder bore  
**OEM # D2OZ-2004-B kit . . . . . 26.95**



## Push Rod to Firewall Seal

Power brake booster push rod to firewall seal with booster - 2¾" long  
 1966-71 Fairlane and Torino (Stock # P02-1065-010)  
**OEM # C0AA-2A021-A each . . . . . 9.95**

**We accept these MAJOR credit cards.**



# 1962-72 Fairlane

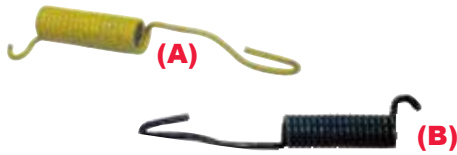

## Brake Shoe Spring

1962-71 Fairlane and Torino

1966-70 Comet - front and rear 10" brakes

1968-70 Montego - front and rear 10" brakes

(Stock # P02-1100-005) (A)

**OEM # 8A-2035 each . . . . . 2.95**

1962-72 Fairlane and Torino - front and rear secondary spring

(Stock # B02-1100-036) (B)

**OEM # C2OZ-2035-A each . . . . . 5.95**



## Brake Adjusting Screw

1962-71 Fairlane - front and rear

1972 Torino - rear

Right hand - (Stock # F02-1110-080)

**OEM # C4TZ-2041-S each . . . . . 12.95**

Left hand - (Stock # X02-1110-081)

**OEM # C4UZ-2041-A each . . . . . 11.95**



## Brake Shoe to Cylinder Link

Requires 8.

1962-71 Fairlane - front and rear

1963 Meteor - front and rear

(Stock # P02-1115-020)

**OEM # B7A-2042-A each . . . . . 3.95**



## Brake Adjuster Screw Spring

1961-72 Fairlane - self-adjusting brakes

1966-71 Comet and Montego - front and rear

(Stock # S02-1130-010) (A)

**OEM # C1SS-2049-A each . . . . . 2.95**

1962 Fairlane - manual adjusting brakes - front and rear

(Stock # P02-1130)

**OEM # 8A-2049 each . . . . . 2.95**



## New Front Wheel Cylinders

1 1/8" cylinder bore

1962 Fairlane - before 1/15/62

1963-65 Fairlane

1966 Fairlane - 200 and 289 except Station Wagon

1967-68 Fairlane - except Convertible, Station Wagon and 390

1969 Fairlane - 302 except Station Wagon and Convertible

1970 Fairlane

1970-71 Torino

Right hand - (Stock # B02-1165-045)

**OEM # C2OZ-2061-A each . . . . . 19.95**

Left hand - (Stock # B02-1170-045)

**OEM # C2OZ-2062-A each . . . . . 16.95**

1 1/2" cylinder bore

1962 Fairlane - from 1/15/62 (A)

Right hand - (Stock # B02-1165-060)

**OEM # C3OZ-2061-C each . . . . . 19.95**

Left hand - (Stock # B02-1170-060)

**OEM # C3OZ-2062-C each . . . . . 19.95**

1 3/2" cylinder bore

1966 Fairlane - 390

1967-68 Fairlane - 390 except Station Wagon

1967-68 Fairlane - Convertible except 390

1967-69 Fairlane - Station Wagon

1969 Fairlane - 250, 302, 351, 390 and 428 Convertible

1966-68 Comet and Cyclone - 390

1968 Montego - 390 Station Wagon

1967-68 Comet and Montego - Convertible except 390

1969 Comet, Montego and Cyclone - 205 and 302 Convertible

1969 Comet, Montego and Cyclone - 351, 390, and 428

Right hand - (Stock # F02-1165-075) **Price Reduced!**

**OEM # C9TZ-2061-B each . . . . . 32.95**

Left hand - (Stock # F02-1170-075)

**OEM # C9TZ-2062-B each . . . . . 32.95**



## Drum Brake Hardware Kit

Brake hold down spring kit includes all springs, anchor, cups and C washers needed.

1962-70 Fairlane - rear axel - 10" x 2"

1962-70 Fairlane - front axel - 10"

(Stock # X02-1175-060)

**OEM # C2DZ-2065-S kit . . . . . 14.95**

1962-69 Fairlane - rear axel - 10 x 1 3/4"

(Stock # B02-1175-065)

**OEM # C2OZ-2065-R kit . . . . . 13.95**



## Brake Shoe Hold Down Kit

1962-71 Fairlane and Torino - rear brakes - 10" x 1 3/4" or 2 1/2"

1966-70 Comet and Montego - rear brakes - 10" x 1 3/4" or 2 1/2" brakes

(Stock # M02-1185-001)

**OEM # A9A-2068-KT kit . . . . . 11.95**

1966-70 Comet and Montego - rear brakes - 10" x 2"

(Stock # M02-1185-002)

**OEM # B5A-2068-KT kit . . . . . 9.95**



## Brake Hold Down Spring

2 3/32" OD - 1 1/6" long

1962-72 Fairlane

(Stock # R02-1185-020)

**OEM # H-2068 each . . . . . .95**

**Friend us on Facebook and follow us on Twitter. You never know what you might be in for.**



**1-800-654-3247**  
**Call Us for**  
**All-American**  
**Deals**

# 1962-72 Fairlane



**Front Brake Hose**  
 1962-65 Fairlane  
 1966 Comet  
 (Stock # P02-1220-030) **Price Reduced! (A)**  
**OEM # B4AZ-2078-A each. . . . . 15.95**  
 13<sup>3</sup>/<sub>8</sub>" long  
 1966 Fairlane **Price Reduced!**  
 (Stock # P02-1220-435)  
**OEM # LD-2078-A each. . . . . 14.95**  
 With disc brakes - 14<sup>1</sup>/<sub>4</sub>" long  
 1967 Fairlane, Comet and Montego  
 (Stock # B02-1220-125)  
**OEM # C7OZ-2078-B each. . . . . 19.95**  
 With drum brakes - 12<sup>5</sup>/<sub>8</sub>" long  
 1967-70 Fairlane **Price Reduced!**  
 1967-71 Torino  
 1967-71 Comet, Cyclone and Montego  
 (Stock # B02-1220-120)  
**OEM # C7OZ-2078-A each. . . . . 11.95**  
 With disc brakes - 12<sup>1</sup>/<sub>4</sub>" long  
 1968-70 Fairlane  
 1968-71 Torino  
 1968-71 Comet and Montego  
 1969-71 Cyclone  
 Right hand - (Stock # B02-1220-160)  
**OEM # C8OZ-2078-A each. . . . . 26.95**  
 Left hand - (Stock # B02-1220-165)  
**OEM # C8OZ-2078-B each. . . . . 52.95**



**Brake Adjusting Hole Cover**  
 Rubber. For front and rear.  
 1962-72 Fairlane and Comet  
 (Stock # P02-1255)  
**OEM # 8A-2092 each. . . . . .95**



**Emergency Brake Arm Clip**  
 1962-69 Fairlane  
 1962-63 Meteor  
 1966-70 Comet, Cyclone and Montego  
 (Stock # V02-1280)  
**OEM # 91A-2106 each. . . . . .95**



**Disc Brake Seal and Boot Kit**  
 This is a disc brake caliper seal and boot kit.  
 1967 Comet, Montego and Cyclone  
 (Stock # M02-1295-005)  
**OEM # C7MY-2120-K kit . . . . . 28.95**  
 1968-71 Comet, Montego and Cyclone  
 (Stock # M02-1295-015)  
**OEM # C8MY-2120-K kit . . . . . 5.95**

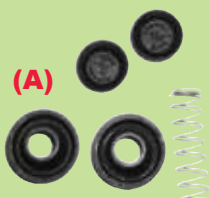

**Rear Wheel Cylinder Repair Kit**  
<sup>27</sup>/<sub>32</sub>" cylinder bore  
 1962 Fairlane - after 1/15/62  
 1962-63 Meteor - heavy duty  
 (Stock # X02-1315-080)  
**OEM # D1DZ-2128-A kit . . . . . 6.95**  
<sup>29</sup>/<sub>32</sub>" cylinder bore  
 1962 Fairlane - before 1/15/62  
 1963-65 Fairlane - except Station Wagon  
 1967-68 Fairlane - except 390 and Station Wagon  
 1970-71 Fairlane - except Station Wagon  
 (Stock # B02-1315-050) **Price Reduced!**  
**OEM # C3OZ-2128-B kit . . . . . 9.95**  
<sup>15</sup>/<sub>16</sub>" cylinder bore  
 1963-69 Fairlane - Station Wagon  
 (Stock # P02-1315-030)  
**OEM # B2A-2128-A kit . . . . . 6.95**  
<sup>7</sup>/<sub>8</sub>" cylinder bore  
 1966-68 Fairlane - 390 except Station Wagon  
 1969 Fairlane - 250, 302, 351, and 428 except Station Wagon  
 (Stock # P02-1315-005) **(A)**  
**OEM # 8A-2128 kit . . . . . 5.95**  
<sup>31</sup>/<sub>32</sub>" cylinder bore  
 1967-71 Fairlane  
 1969 Comet - 250 and 302 except Convertible and Station Wagon  
 1970-71 Montego  
 (Stock # P02-1315-055)  
**OEM # C5AZ-2128-A kit . . . . . 14.95**  
<sup>31</sup>/<sub>32</sub>" cylinder bore **Price Reduced!**  
 1970-71 Torino and Gran Torino  
 1970-71 Fairlane - Station Wagon  
 (Stock # P02-1315-060)  
**OEM # C5AZ-2128-B kit. . . . . 9.95**  
<sup>1</sup>/<sub>8</sub>" cylinder bore  
 1970-71 Fairlane  
 1971 Comet and Montego - 250 and 8 cylinder  
 (Stock # F02-1315-070)  
**OEM # C5TZ-2128-B kit. . . . . 5.95**  
<sup>27</sup>/<sub>32</sub>" cylinder bore  
 1971-72 Comet  
 1972 Montego  
 (Stock # X02-1315-065)  
**OEM # C5DZ-2128-B kit. . . . . 5.95**



**Push Rod Spacer**  
 Brake master cylinder push rod spacer -  
<sup>9</sup>/<sub>16</sub>" ID - <sup>1</sup>/<sub>8</sub>" thick  
 1965-72 Fairlane and Torino  
 (Stock # X02-1316-100)  
**OEM # C5DZ-2B129-A each . . . . . 1.95**

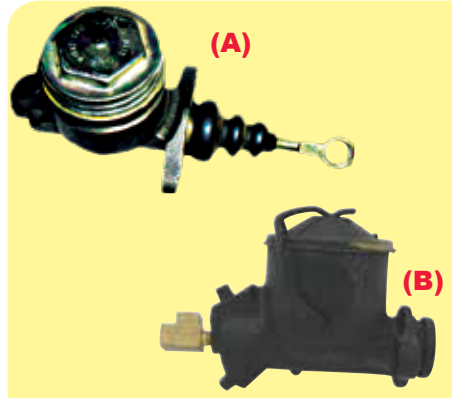

**Master Cylinder**  
<sup>1</sup>" cylinder bore  
 1962-65 Fairlane - after 1/3/66 - manual drum brakes  
 1962-63 Meteor - manual brakes **(A)**  
 (Stock # P02-1335-065) **Price Reduced!**  
**OEM # C2AZ-2140-B each . . . . . 77.95**  
<sup>15</sup>/<sub>16</sub>" cylinder bore  
 1962-66 Fairlane - before 1/3/66 - power drum brakes  
 1962-63 Meteor  
 (Stock # B02-1335-070) **(B)**  
**OEM # C2OZ-2140-A each. . . . . 83.95**  
<sup>1</sup>" cylinder bore  
 1966 Fairlane and Comet  
 (Stock # B02-1335-095)  
**OEM # C6OZ-2140-D each . . . . . 89.95**  
<sup>15</sup>/<sub>16</sub>" cylinder bore  
 1967-71 Fairlane and Torino - power drum and power disc brakes  
 1967-71 Comet, Montego and Cyclone  
 (Stock # B02-1335-140)  
**OEM # C8OZ-2140-A each. . . . . 99.95**  
<sup>1</sup>" cylinder bore  
 1967-70 Fairlane and Torino  
 1967-70 Comet  
 1967-71 Montego  
 1967-71 Cyclone  
 (Stock # B02-1335-170)  
**OEM # C9OZ-2140-A each. . . . . 109.95**  
<sup>1</sup>" cylinder bore  
 1972 Torino - manual disc brakes  
 (Stock # B02-1335-180)  
**OEM # D2OZ-2140-B each . . . . . 62.95**



# 1962-72 Fairlane



## Ford® Manual Disc/Drum Master Cylinder

Master cylinder for Ford® disc/drum applications. Deep piston hole for manual brakes. Left ports. 1" bore. (A)

MC11378M ..... 89.95

Left ports. 1½" bore.

MC11680M ..... 99.95



## Ford® Power or Manual Disc/Disc Master Cylinder

Master cylinder for Ford® disc/disc applications. Deep piston hole for power or manual brakes. Right ports. 1½" bore.

MC11897P/M ..... 139.95

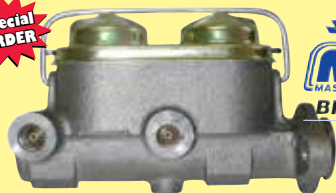

## Ford® Manual Drum/Drum Master Cylinder

Master cylinder for Ford® drum/drum applications. Deep piston hole for manual brakes. Left ports. 1" bore.

MC11488M ..... 99.95

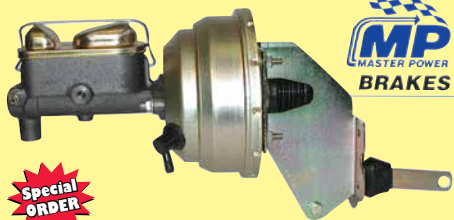

## Ford® 7" Dual Diaphragm Power Booster/Master Cylinder

For 1966-69 Fairlane and Torino. 1" bore master cylinder for disc/drum applications.

BM1510 ..... 395.00



## Silicone Brake Fluid

This is the end of condensation in your brake system. Fits all years with hydraulic brakes. 1 quart.

(Stock # Z02-1340)

OEM # M-2141-SBF each ..... 18.95



## Brake Line Gasket

1962-72 Fairlane - 1962-63 Meteor

1966-71 Comet, Montego and Cyclone

(Stock # M02-1350) - .39 ID x .62 OD

OEM # 8M-2149 each ..... .95

(A)



(B)

## Brake Master Cylinder Filler Cap

Chrome plated

1962-66 Fairlane - drum brakes

1966 Comet - drum brakes

(Stock # P02-1380-030)

OEM # C5ZZ-2162-B each ..... 22.95

Original gold color with gasket

1962-66 Fairlane - drum brakes

1966 Comet - drum brakes

(Stock # P02-1380-040)

OEM # C5ZZ-2162-G each ..... 19.95

Gold cadmium

1967 Fairlane - disc brakes

(Stock # P02-1380-043)

OEM # C7AZ-2162-B each ..... 18.95

1967-71 Fairlane and Torino - drum brakes

(Stock # P02-1380-060)

OEM # C7AZ-2162-A each ..... 25.95

Chrome with Concours marking. Includes diaphragm and locking bail.

1967-71 Fairlane and Torino - disc brakes

(Stock # P02-1380-041)

OEM # C7AZ-2162-C each ..... 19.95

Chrome plated, diaphragm NOT included.

1967-71 Fairlane and Torino - drum brakes

(Stock # P02-1380-042)

OEM # C9AZ-2162-C each ..... 27.95



## Disc Pad Retainer Clip Kit

1967 Fairlane

(Stock # B02-1380-110)

OEM # C7OZ-2B164-A kit ..... 27.95



## Master Cylinder Filler Cap Gasket

1967-71 Fairlane and Torino

1967-71 Comet, Montego and Cyclone

(Stock # P02-1390-020) - drum brakes

OEM # C7AZ-2167-A each. (A) . . . 6.95

1967 Comet - power brakes

1968-70 Comet and Montego - disc brake

(Stock # F02-1390-030)

OEM # D1FZ-2167-B each ..... 19.95



## Brake Shoe Adjusting Lever

1962-64 Fairlane - left hand

(Stock # F02-1400-100)

OEM # COLL-2A177-A each ..... 3.95



## Brake Self Adjuster Cable

Requires 4. Uses 1 cable per drum.

1962-71 Fairlane - front or rear

(Stock # B02-1405-006)

OEM # C2OZ-2A178 each ..... 2.95



## Brake Master Cylinder Boot

1962-71 Fairlane - drum brakes

(Stock # P02-1410)

OEM # OA-2180 each ..... 4.95



Please allow  
7-14 days for  
Special Orders!

# 1962-72 Fairlane

Brake Parts



## Rear Drum Brake Shoes

Set does two wheels.

10 x 2" brakes

1966-68 Fairlane - 390 except Station Wagon

1966-70 Comet - 351, 390, and 428 Sedan

1967-68 Fairlane and Torino - except Station Wagon and 351 and 429 - with disc brakes

1968-70 Montego and Cyclone - 351, 390 and 428 Sedan

1969-70 Comet - Station Wagon

1969-71 Fairlane - Sedan and Station Wagon

1969-71 Fairlane and Torino - except Station Wagon and 351 and 429 - with disc brakes

1969-71 Torino - Station Wagon except 302

1969-71 Torino - Sedan

1972 Torino - except 351, 400 and 429 - disc brakes

(Stock # B02-1430-040) - set of 4

**OEM # C6OZ-2200-A set . . . . . 41.95**



## Wheel Cylinder Bleeder Screw

1962-71 Fairlane and Torino

1962-63 Meteor

1966-71 Comet, Montego and Cyclone (Stock # M02-1445)

**OEM # 8M-2208 each . . . . . 1.95**

**We accept these MAJOR credit cards.**

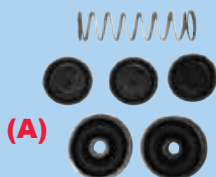

## Front Wheel Cylinder Kit

1 1/8" cylinder bore

1962 Fairlane - before 1/15/62

1963-65 Fairlane

1966 Fairlane - 200 and 289 exc St Wagon

1967-68 Fairlane - except Convertible, Station Wagon and 390 engine

1969 Fairlane - 250 and 302 except Station Wagon and Convertible

(Stock # B02-1470-033)

**OEM # C2OZ-2221-A kit . . . . . 5.95**

1 1/8" cylinder bore

1962 Fairlane - from 1/15/62

(Stock # P02-1470-032)

**OEM # C2AZ-2221-A kit . . . . . 6.95**

1 1/16" cylinder bore

1962-63 Meteor

(Stock # B02-1470-035)

**OEM # C2OZ-2221-B kit . . . . . 4.95**

1 1/16" cylinder bore

1962-65 Fairlane - 10 x 2 1/2" brakes

(Stock # B02-1470-046)

**OEM # C3OZ-2221-C kit . . . . . 5.95**

1 3/32" cylinder bore

1966 Fairlane - 390

1967-68 Fairlane - 390 - except Station Wagon

1967-68 Fairlane - Convertible except 390

1967-69 Fairlane - Station Wagon

1969 Fairlane - 250 and 302 Convertible

1969 Fairlane - 351, 390 and 428 - except Station Wagon

1966-69 Comet - 390 and Station Wagon

1967-68 Montego - except 390

1967-69 Cyclone - except 390

1969 Comet - Convertible 250 and 302

1969 Comet - 351, 390 and 428

(Stock # P02-1470-040)

**OEM # C3AZ-2221-A kit . . . . . 6.95**

1 1/8" cylinder bore

1962-71 Fairlane and Torino

1962-63 Meteor

1966 Comet - 200 and 289 except Station Wagon

1967-68 Montego - 8 cylinder except Convertible and Station Wagon with 390

1969 Montego and Cyclone - 250 and 302 except Station Wagon

1970 Montego and Cyclone

(Stock # B02-1470-045)

**OEM # C3OZ-2221-B kit . . . . . 5.95**

Price Reduced!

(A)



## Outer Rear Wheel Bearing Retainer Gasket

1963-69 Fairlane

(Stock # P02-1525)

**OEM # 8A-2245 each. . . . . 3.95**



## Backing Plate to Rear Axle Housing Gasket

1963-69 Fairlane

(Stock # P02-1550)

**OEM # 8A-2256 each. . . . . 3.95**



(A)

## Rear Brake Wheel Cylinder

2 7/32" cylinder bore

1962 Fairlane

1962-63 Meteor

Right hand - (Stock # B02-1565-045)

**OEM # C2OB-2261-A each . . . . . 0.00**

Left hand - (Stock # B02-1570-035)

**OEM # C2OB-2262-A each . . . . . 29.95**

2 9/32" cylinder bore

1962 Fairlane - before 1/15/62

1962-63 Meteor

1963-65 Fairlane - except Station Wagon

1966 Fairlane - 200 and 289 except Station Wagon

1966 Comet - 200 and 289 except Station Wagon

1967-68 Fairlane - Convertible except 390

1967-68 Fairlane - except Station Wagon

and 390

1967-68 Comet and Cyclone - except Station Wagon with 390

1967-68 Montego - except 390 and Station Wagon

1970 Fairlane - except Station Wagon

1970 Cyclone - except Station Wagon

1970-71 Montego - except Station Wagon

Right hand - (Stock # B02-1565-050)

**OEM # C2OZ-2261-A each. . . . . 18.95**

Left hand - (Stock # B02-1570-040)

**OEM # C2OZ-2262-A each. . . . . 18.95**

1962 Fairlane - from 1/15/62

Right hand - (Stock # B02-1565-051)

**OEM # C2OZ-2261-B each. . . . . 36.95**

Left hand - (Stock # B02-1570-041)

**OEM # C2OZ-2262-B each. . . . . 36.95**

# 1962-72 Fairlane



## Rear Brake Wheel Cylinder

1 5/16" cylinder bore

1963-69 Fairlane - Station Wagon  
1966-69 Comet - Station Wagon  
1967-68 Montego and Cyclone - Station Wagon

1969 Montego - Station Wagon  
Right hand - (Stock # P02-1565-095)

**OEM # C7AZ-2261-A each . . . . . 12.95**

Left hand - (Stock # P02-1570-085)

**OEM # C7AZ-2262-A each . . . . . 12.95**

7/8" cylinder bore

1966-68 Fairlane - 390 except Station Wagon  
1966 Comet - 390 except Station Wagon  
1966-69 Fairlane -200, 250, 289 and 302  
1967-68 Montego - 390 except Station Wagon

1967-68 Montego and Cyclone - 390 Convertible with disc brakes  
1967-68 Comet - 390 with disc brakes  
1969 Fairlane - except Station Wagon  
1969 Montego and Cyclone - except Station Wagon

1969 Comet - 351, 390 and 428 except Station Wagon

1969 Montego and Cyclone - except Station Wagon with disc brakes

1969 Comet - all with disc brakes (A)

Right hand - (Stock # P02-1565-005)

**OEM # 8A-2261 each . . . . . 12.95**

Left hand - (Stock # P02-1570-005)

**OEM # 8A-2262 each . . . . . 12.95**

3 1/32" cylinder bore

1970 Fairlane - Station Wagon  
1970-71 Torino

Right hand - (Stock # P02-1565-067)

**OEM # C5AZ-2261-A each . . . . . 24.95**

Left hand - (Stock # P02-1570-055)

**OEM # C5AZ-2262-A each . . . . . 38.95**



## Brake Pressure Differential Valve Warning Lamp Switch

1968-69 Fairlane/Torino  
(Stock # P02-1575-005)

**OEM # C8AZ-2B264-A each . . . . . 34.95**



## Pre-bent Steel Brake Line Kits

Complete line kit in plain steel.

### Required information:

1. Year of Car
2. Body style
3. Type of Brakes (Manual Drum, Power Disc etc.)
4. Axle Size - 8" or 9"

If additional information is needed, please leave us a contact number as these are **Special Order per application and NON-returnable**. Oversized shipping applies.

1963-71 Fairlane/Torino

**OEM # C3OZ-2265-SPO set . . . . . 202.95**

1964-66 Comet

**OEM # C4GY-2265-SPO set . . . . . 149.95**

1966-69 Cyclone

**OEM # C6GY-2265-SPO set . . . . . 0.00**



**Special ORDER**



## Rear Brake Hose

1962-65 Fairlane  
(Stock # S02-1220-095) - 15 1/4" long **Price Reduced!**

**OEM # C2SZ-2078-B each . . . . . 16.95**

1966 Fairlane - except Station Wagon

1966 Comet - except Station Wagon

(Stock # B02-1635-050) - 17 1/8" long

**OEM # C6OZ-2282-D each . . . . . 45.95**

1967-68 Ranchero and Station Wagon

1969-71 Fairlane and Torino - except Ranchero and Station Wagon not 15 1/8" long

1967-71 Comet and Montego - Station Wagon

(Stock # B02-1635-085) - 15 1/8" long

**OEM # C7OZ-2282-A each . . . . . 39.95**

1967 Fairlane and Comet - 6 cylinder Sedan and Hardtop built before 4/3/67

1967-68 Fairlane - 8 cylinder

1967-68 Comet - 289, 302 and 390 Sedan, Hardtop and Convertible

1969-71 Fairlane and Torino - except Ranchero and Station Wagon

1969-71 Comet and Montego - except Station Wagon

(Stock # B02-1635-090) - 17 1/8" long

**OEM # C7OZ-2282-B each . . . . . 77.95**



## Return Line Clamp

Power steering return line clamp and oil return line clamp, reservoir to pump hose.

1960-70 Fairlane

(Stock # P02-1655)

**OEM # B5A-2344-A each . . . . . 2.95**



## Power Brake Booster Check Valve

1965-68 Fairlane

(Stock # P02-1680-005)

**OEM # C4AZ-2365-A each . . . . . 29.95**

1969-70 Fairlane - disc brakes

1969-70 Comet

(Stock # P02-1680-020)

**OEM # D0AZ-2365-A each . . . . . 11.95**



# 1962-72 Fairlane

Brake Parts



### Clutch and Brake Pedal Pad

Clip on pad  
1962-67 Fairlane - manual transmission  
(Stock # P02-1730-020)  
**OEM # B7A-2457-A each . . . . . 4.95**



### Brake Pedal Pad

1967-71 Fairlane - manual trans/disc brakes  
1967-70 Montego - manual trans/disc brakes  
(Stock # P02-1715-090)  
**OEM # C5ZZ-2454-D each . . . . . 6.95**



### Disc Brake Pedal Pad

1967-71 Fairlane  
1967-70 Comet  
1967-71 Torino  
(Stock # P02-1715-105) - auto trans/disc brake  
**OEM # D3ZZ-2454-A each . . . . . 7.95**



### Brake or Clutch Pedal Pad

1965-66 Fairlane  
(Stock # P02-1730-035)  
**OEM # C5AZ-2457-A each . . . . . 6.95**



### Parking Brake Pedal Pad

1966-71 Fairlane and Montego **Price Reduced!**  
(Stock # B02-1715-095)  
**OEM # C6OZ-2454-A each . . . . . 5.95**



### Parking Brake Pedal Pad

1972 Fairlane **Price Reduced!**  
(Stock # S02-1715-100)  
**OEM # C8SZ-2454-A each . . . . . 4.95**

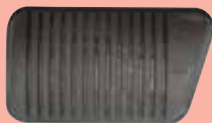

(A)

### Brake Pedal Pads

1962-65 Fairlane - manual or power brakes and automatic transmission  
(Stock # X02-1730-030)  
**OEM # C0DD-2457-A each . . . . . 7.95**  
1966-71 Fairlane - manual brakes and manual transmission  
1966-68 Torino - disc brakes and manual transmission  
1966-72 Comet - manual brakes and manual transmission  
1966-72 Montego - manual brakes and manual transmission  
1972 Torino - disc brakes and manual transmission  
(Stock # P02-1730-050) **(A)**  
**OEM # C5ZZ-2457-G each . . . . . 3.95**  
1966-71 Fairlane - manual brakes and automatic transmission  
1968-71 Torino - manual brakes and automatic transmission  
1966-71 Comet and Montego - manual drum brakes and automatic transmission  
(Stock # B02-1730-060)  
**OEM # C6OZ-2457-B each . . . . . 6.95**  
1972 Torino  
(Stock # S02-1730-075)  
**OEM # D2SZ-2457-A each . . . . . 19.95**



### Brake Master Cylinder Link Rod Bolt

1965-67 Fairlane - power brakes  
(Stock # F02-1745-010) - 3/8" - 24 x 1-11/32"  
**OEM # C0TT-2462-A each . . . . . 0.00**

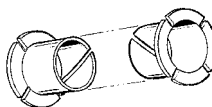

### Brake and Clutch Mounting Bracket Bushing

Clutch pedal requires 2. Brake pedal requires 4.  
1962-68 Fairlane  
1966-68 Comet - clutch and brake  
1969-70 Comet - brake only  
(Stock # P02-1770)  
**OEM # B7AZ-2471-A each . . . . . 1.95**  
1969-70 Fairlane  
(Stock # B02-1770-010)  
**OEM # C9OZ-2471-B each . . . . . 3.95**



### Brake Master Cylinder Push Rod Bushing

1962-64 Fairlane  
(Stock # P02-1785) - 1/8" long  
**OEM # B2A-2474-A each . . . . . 1.95**  
1965-68 Fairlane and Comet **Price Reduced!**  
(Stock # X02-1785-010) - 5/16" long  
**OEM # C5DZ-2474-A each . . . . . 1.95**  
1969-70 Fairlane and Comet **Price Reduced!**  
(Stock # P02-1785-020) - 5/16" long  
**OEM # C9AZ-2474-A each . . . . . 2.95**

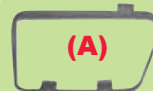

(A)

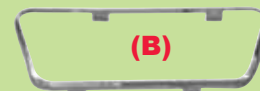

(B)

### Brake Pedal Pad Cover, Stainless Steel Trim

1966-67 Caliente and Cyclone  
1966-71 Fairlane - manual transmission  
1967-71 Fairlane - automatic transmission  
1968-71 Torino - automatic transmission  
(Stock # P02-1830) **(A)**  
**OEM # C5ZZ-2A487-C each . . . . . 7.95**  
1966-68 Caliente and Cyclone  
1966-71 Fairlane - automatic transmission  
1968-71 Torino - automatic transmission  
(Stock # B02-1830-005) **(B)**  
**OEM # C6OZ-2A487-A each . . . . . 10.95**



### Parking Brake Link Spring

1966-68 Caliente and Cyclone  
1969-70 Comet  
(Stock # F02-2145-005)  
**OEM # C6TZ-2A601-A each . . . . . 4.95**



### Parking Brake Cable Equalizer

1962-65 Fairlane  
(Stock # X02-2150)  
**OEM # C0DD-2A602-A each . . . . . 5.95**  
1966-72 Fairlane  
1966-70 Comet **Price Reduced!**  
(Stock # B02-2150-010)  
**OEM # C6OZ-2A602-A each . . . . . 16.95**

*Check those prices on-line!  
See our website for current pricing.*

# 1962-72 Fairlane



## Parking Brake Equalizer Rod

Universal - 12" long. Cut from thread end to required length.

1962-72 Fairlane and Torino

1971 Comet and Montego

(Stock # P02-2175-005)

**OEM # B7A-2628-B each . . . . . 8.95**

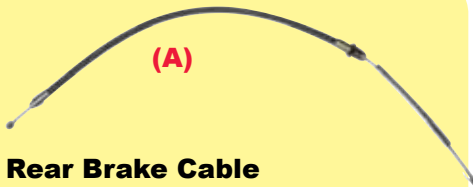

## Rear Brake Cable

1962-65 Fairlane

(Stock # B02-2195-100) - 162½" long (A)

**OEM # C2OZ-2635-A each . . . . . 63.95**

1966-68 Fairlane - except Ranchero and Station Wagon

(Stock # B02-2195-215) - 91" long

**OEM # C6OZ-2A635-C each . . . . . 76.95**

1966-71 Ranchero and Station Wagon

(Stock # B02-2195-220) - 176" long

**OEM # C6OZ-2A635-D each . . . . . 24.95**

1969-71 Torino - except Ranchero and Station Wagon

Right hand - (Stock # B02-2195-265) - 152" long

**OEM # C9OZ-2A635-A each . . . . . 79.95**

Left hand - (Stock # B02-2195-270) - 30" long

**OEM # C9OZ-2A635-B each . . . . . 74.95**



## Parking Brake Release Handle

1962-65 Fairlane

1962-63 Meteor

(Stock # X02-2360)

**OEM # C0DZ-2760-B each . . . . . 5.95**



## Parking Brake Ratchet Bar Pawl

1960-65 Fairlane

(Stock # M02-2390)

**OEM # 0M-2786 each . . . . . 9.95**



## Parking Brake Ratchet Bar Pawl Locking Spring

1962-65 Fairlane

(Stock # M02-2400)

**OEM # 0M-2788 each . . . . . 2.95**



## Parking Brake Cable Connector

1966-71 Fairlane - except Ranchero and Station Wagon

1966-71 Comet - except Station Wagon

(Stock # B02-2405-005)

**OEM # C6OZ-2A790-A each . . . . . 9.95**



## Parking Brake Cable Pulley

1962-65 Fairlane

1966-70 Comet

(Stock # M02-2445)

**OEM # 0M-2804 each . . . . . 23.95**



## Brake Hose and Handbrake Cable Clamp

1962-64 Fairlane - parking brake cable to control

(Stock # M02-2460-01) (A)

**OEM # 8M-2814 each . . . . . 2.95**

1965-71 Fairlane - as required

(Stock # V02-2460-005)

**OEM # 78-2814-A each . . . . . 0.95**

1965-71 Fairlane - as required

(Stock # P02-2460-015)

**OEM # A7AZ-2814-A each . . . . . 1.95**

1972 Torino - as required

(Stock # P02-2460-020)

**OEM # C7AZ-2814-A each . . . . . 1.95**

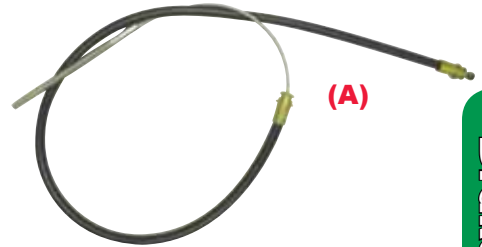

## Front Parking Brake Cable and Conduit

1962-65 Fairlane

(Stock # B02-2555-190) - 57" long

**OEM # C3OZ-2853-A each . . . . . 66.95**

1966-67 Fairlane

(Stock # B02-2555-215) - 44¾" long (A)

**OEM # C6OZ-2853-A each . . . . . 32.95**

1968-71 Fairlane, Torino and Comet

(Stock # B02-2555-240) - 43¾" long

**OEM # C8OZ-2853-A each . . . . . 33.95**



## Air Compressor Belt Idler Pulley Bearing Assembly

1962-65 Fairlane - 200,250

(Stock # B02-2580)

**OEM # C3OZ-2873-A each . . . . . 58.95**



## Air Conditioner Brush and Holder Assembly

1962 Fairlane - used on compressor with top mounted hoses

(Stock # P02-2665)

**OEM # C0AE-2979-E each . . . . . 42.95**



## Air Conditioner Compressor Switch and Bracket

1965-58 Fairlane

(Stock # S02-2665-200)

**OEM # C8SZ-2979-A each . . . . . 44.95**

**Obsolete & Classic Auto Parts, Inc.**

**An American Classic!**

Brake Parts

# 1962-72 Fairlane



### Power Steering Return Line Hose

3/8" ID x 5/8" OD - Universal Application  
(Stock # P03-3025-005)  
**OEM # C7AZ-3A005-A each . . . . 19.95**



### Power Steering Oil Reservoir Filler Cap Seal

1962-65 Fairlane - 8 cylinder - without A/C  
(Stock # P03-3030-005)  
**OEM # C1AA-3A006-A each . . . . 1.95**



### Power Steering Oil Reservoir Filler Cap

1965-66 Fairlane  
1966 Comet  
Use with straight, vertical reservoir filler tube - for Ford® pumps.  
(Stock # P03-3030-010)  
**OEM # C5AZ-3A006-B each. . . . 13.95**  
Use with angular reservoir filler tube - for Ford® pumps - with dipstick.  
(Stock # P03-3030-015)  
**OEM # C5AZ-3A006-C each. . . . 14.95**



### Front Suspension Bumper

1962-65 Fairlane  
(Stock # B03-3085-085) **(A)**  
**OEM # C3OZ-3020-B each. . . . . 12.95**  
1966-68 Fairlane/Comet/Montego  
(Stock # B03-3085-095) **(B)**  
**OEM # C6OZ-3020-A each. . . . . 6.95**  
1969-71 Fairlane/Torino/Comet  
(Stock # B03-3085-100) **(C)**  
**OEM # C9OZ-3020-A each. . . . . 9.95**



### Upper Control Arm Shaft Kits

1962-65 Fairlane - 1 shaft does 1 arm - complete with bushings, no bolts.  
(Stock # B03-3190-035)  
**OEM # C3OZ-3047-B kit . . . . . 279.95**  
1966-71 Fairlane/Comet/Montego - with bolts & no bushings  
(Stock # B03-3190-055) **(A)**  
**OEM # C6OZ-3047-A kit . . . . . 24.95**  
1972 Fairlane (bef 3/15/72) **Price Reduced!**  
(Stock # P03-3190-045)  
**OEM # C5AZ-3047-A kit . . . . . 79.95**



### Upper Inner Arm Shaft Bushing

1972 Torino - except heavy duty suspension  
(Stock # P03-3275-020) - requires 4  
**OEM # C5AZ-3068-A each. . . . . 3.95**



### Front Upper Ball Joint

**4 bolt style**  
1962-69 Fairlane  
1966-69 Comet  
(Stock # B03-3200-050)  
**OEM # C7OZ-3049-A each. . . . . 26.95**  
**3 bolt style**  
1966-71 Comet/Montego  
1970-71 Torino  
(Stock # B03-3200-060)  
**OEM # D0OZ-3049-A each . . . . 17.95**



### Lower Ball Joint

1966-67 Fairlane - pressed-in  
(Stock # B03-3205-040)  
**OEM # C6OZ-3050 each . . . . . 74.95**  
Requires 2 - bolts on  
1966-71 Fairlane, Torino & Comet  
(Stock # X03-3205-025)  
**OEM # C2DZ-3050-A each. . . . . 69.95**



### Lower Control Arm Shaft Kit

Without bushings  
1966-71 Fairlane - 1 kit does 1 arm  
(Stock # B03-3195-051)  
**OEM # C6OZ-3048-KT kit . . . . . 39.95**



### Lower Control Arm Bushing

1962-65 Fairlane  
(Stock # P03-3280-026) - 2" ID  
**OEM # C2OZ-3069-B each. . . . . 75.95**  
1966-71 Fairlane  
(Stock # B03-3280-050) - 1 1/2" ID  
**OEM # C6OZ-3069-A each. . . . . 11.95**  
1972 Torino  
(Stock # P03-3280-045) - 1/2" ID **Price Reduced!**  
**OEM # C5AZ-3069-A each. . . . . 9.95**



### Lower Control Arm Assembly

Includes ball joint and bushings as shown.  
1966-67 Fairlane  
(Stock # B03-3305-010) - black **(A)**  
**OEM # C7OZ-3078-A each. . . . . 69.95**  
1968-71 Fairlane/Comet/Montego  
(Stock # B03-3305-030) - black **(B)**  
**OEM # D1OZ-3078-A each . . . . 69.95**



### Grease Fitting Kit

Special zerks fittings with extra long extensions. Allows easy access to hard to reach zerks fittings. Helps solve squeaky upper control arms. Installation tool included.  
1962-65 Fairlane  
(Stock # X03-3325-002)  
**OEM # C4DZ-3082-KT kit. . . . . 22.95**

# 1962-72 Fairlane



### Upper Control Arm Assembly

Complete with upper shaft kit and ball joint  
1966-71 Fairlane/Torino/Comet  
(Stock # B03-3325-005)  
**OEM # C7OZ-3082-A each . . . . . 89.95**



### Ball Joint Seal (Dust Boot)

1965-71 All  
(Stock # B03-3385-095) - lower  
**OEM # C7OZ-3A105-A each . . . . . 6.95**  
1965-69 All  
(Stock # B03-3385-100) - upper  
**OEM # C7OZ-3A105-B each . . . . . 7.95**



### Outer Tie Rod End

1962-65 Fairlane - power steering  
(Stock # B03-3465-028) - left hand  
**OEM # C3OZ-3A131-A each . . . 129.95**  
1962-65 Fairlane - manual steering  
(Stock # B03-3460-136) - fits either side  
**OEM # C3OZ-3A130-B each . . . 179.95**  
1966 Fairlane - manual or power steering  
1966 Comet  
(Stock # B03-3460-165) - fits either side  
**OEM # C6OZ-3A130-A each . . . . 41.95**  
1967-69 Fairlane - manual or power steering  
1966-69 Comet and Montego  
(Stock # P03-3460-190) - fits either side  
**OEM # C7ZZ-3A130-A each . . . . . 19.95**  
1970-71 Torino - manual or power steering  
1970-71 Comet and Montego  
(Stock # B03-3460-205) - fits either side  
**OEM # D0OZ-3A130-B each . . . . 16.95**  
1971 Comet  
(Stock # P03-3460-210) - fits either side  
**OEM # D0ZZ-3A130-B each . . . . 29.95**



### Inner Spindle Connecting Rod

1966 Fairlane and Comet  
(Stock # B03-3460-170) - fits either side  
**OEM # C6OZ-3A130-B each . . . 153.95**  
1967-69 Fairlane - power or manual steering  
1967-69 Comet and Montego  
(Stock # B03-3460-185) - fits either side  
**OEM # C7OZ-3A130-A each . . . . 27.95**  
1970 Comet  
1970-71 Torino/Montego  
(Stock # B03-3465-070) - fits either side  
**OEM # D0OZ-3A131-A each . . . . 35.95**



### Strut Rod Bushing Kit

1962-65 Fairlane  
(Stock # B03-3555) - 12 pieces  
**OEM # C2OZ-3A187-A kit . . . . . 8.95**  
1966-67 Fairlane and Comet  
(Stock # B03-3555-015) - 12 pieces  
**OEM # C6OZ-3A187-A kit . . . . . 15.95**  
1970-71 Torino and Montego  
(Stock # X03-3555-005) - 6 pieces  
**OEM # D0OZ-3A187-KT kit . . . . 29.95**



### Spindle Connecting Rod

1962-65 Fairlane - manual steering  
(Stock # B03-3670-045)  
**OEM # C3OZ-3280-A each . . . . 139.95**  
1962-65 Fairlane - power steering  
(Stock # B03-3670-050) (A)  
**OEM # C3OZ-3280-B each . . . . 209.95**



### Drag Link Adjusting Sleeve

1962-65 Fairlane - manual steering  
(Stock # B03-3760-010)  
**OEM # C2OZ-3310-A each . . . . . 15.95**  
1962-65 Fairlane - power steering  
1965-72 Comet and Montego - all  
1966-71 Fairlane - all  
(Stock # V03-3760)  
**OEM # 11A-3310 each . . . . . 14.95**  
1972 Fairlane - all  
(Stock # P03-3760-015)  
**OEM # D3AZ-3310-A each . . . . . 25.95**



### Drag Link End Seal Kit

1962-72 Fairlane and Torino  
(Stock # V03-3820)  
**OEM # 48-3332-S kit . . . . . 4.95**



### Front Spindle Arm Connecting Rod End Seal

1969-72 Fairlane and Torino  
(Stock # P03-3820-050)  
**OEM # C9AZ-3332-A each . . . . . 6.95**



### Tie Rod Dust Seal

With metal ring for original style press fit  
1966-69 Fairlane  
(Stock # B03-3820-047)  
**OEM # C6OZ-3332 each . . . . . 5.95**



Classic Auto Parts has been serving your car and truck needs since 1974!  
We appreciate our customers!

**1-800-654-3247**  
**Call Us for**  
**All-American**  
**Deals**

# 1962-72 Fairlane

Steering Parts

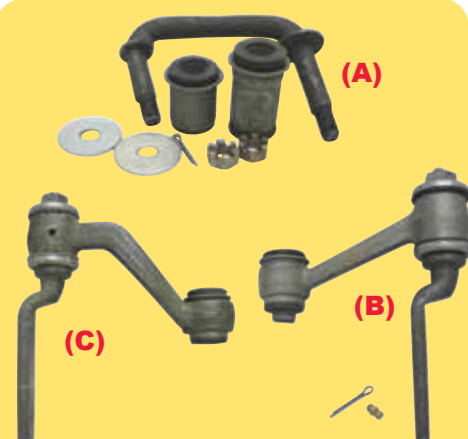

## Steering Idler Arm and Bracket Assembly

- 1962-64 Fairlane before 3/2/64 - manual steering  
(Stock # B03-3865-060) **OEM # C2OZ-3352-A kit . . . . . 139.95** (A)
- 1962-65 Fairlane - power steering  
(Stock # B03-3865-065) **OEM # C2OZ-3352-B kit . . . . . 249.95**
- 1964-65 Fairlane from 3/2/64 - power steering  
(Stock # B03-3865-110) **OEM # C4OZ-3352-A kit . . . . . 119.95**
- 1966 Fairlane - all  
(Stock # B03-3855-001) **OEM # C6OZ-3350-A kit . . . . . 109.95**
- 1967-69 Fairlane - manual steering  
(Stock # B03-3855-005) **OEM # C7OZ-3350-A kit . . . . . 205.95** (B)
- 1967-69 Fairlane/Comet - power steering  
(Stock # B03-3855-010) **OEM # C7OZ-3350-B kit . . . . . 79.95** (C) Price Reduced!
- 1970-71 Fairlane/Comet/Montego - power steering  
(Stock # B03-3855-025) **OEM # D0OZ-3350-B kit . . . . . 59.95**
- 1970-71 Comet and Montego - all  
(Stock # X03-3875-010) **OEM # D3DZ-3355-A kit . . . . . 43.95**
- 1972 Torino - all  
(Stock # B03-3875-015) **OEM # D3OZ-3355-A kit . . . . . 34.95** (C)



## Upper Steering Idler Arm Bushing

- 1962-64 Fairlane - before 3/2/64  
1964-65 Fairlane - after 3/2/64  
(Stock # P03-3880-010) - power steering **OEM # C3AZ-3356-A each . . . . . 11.95** (A)
- 1964-65 Fairlane - from 3/2/64  
(Stock # P03-3880-030) - manual steering **OEM # C5ZZ-3356-A each . . . . . 39.95**



## Lower Steering Idler Arm

- 1962-64 Fairlane - before 3/2/64 - power or manual steering  
1964-65 Fairlane after 3/2/64 - power steer  
1966 Comet - 6 cylinder power steering  
(Stock # P03-3885)  
**OEM # C3AZ-3358-A each . . . . . 15.95**
- 1964-65 Fairlane from 3/2/64 - manual steer  
(Stock # B03-3885-002)  
**OEM # C4OZ-3358-A each . . . . . 69.95**
- 1966 Fairlane - all  
(Stock # B03-3885-007)  
**OEM # C6OZ-3358-A each . . . . . 11.95**
- 1967-72 Fairlane/Torino - manual steering  
1967-71 Comet and Montego - manual steer  
(Stock # P03-3885-005) **OEM # C5AZ-3358-A each . . . . . 7.95** (A)
- 1967-71 Fairlane and Torino - power steering  
1967-71 Montego - power steering  
1967-69 Comet - power steering  
(Stock # B03-3885-010)  
**OEM # C7OZ-3358-A each . . . . . 9.95**



## Shock Tower Nut Set

- 1962-72 Fairlane  
1966-71 Comet  
(Stock # P03-3945)  
**OEM # C0AZ-3382-MB set 6 . . . . . 0.00**



## Front Spring Lower Seat and Bushing Assembly

- Front suspension upper arm spring seat and bushing assembly.  
1965-71 Fairlane/Torino/Comet/Montego  
(Stock # B03-3950)  
**OEM # C7OZ-3388-B each . . . . . 24.95**

**It is not the employer who pays the wages. Employers only handle the money. It is the customer who pays the wages.**

~ Henry Ford

Dakota Digital

Special ORDER



## Cruise Control

This is the only cruise control that will work with the high performance motors of street rods and sport trucks. This advanced electric servo cruise control uses solid state electronics for exceptional accuracy and reliability. It requires no vacuum and will work with radical camshafts and blown motors. Small and quiet enough to hide under any dash. A simple wiring harness and built-in self-diagnostic check makes for exceptionally easy installation. Add the safety and convenience of cruise control to your vehicle today. 36 month/36,000 mile warranty.

For vehicles with cable driven speedometers: Includes electric servo, mounting hardware, wiring harness, electric speed sensor and choice of control handle. Speed sensor attaches in-line with speedometer cable

**CRS-2000 each . . . . . 280.00**

For vehicles with electric speedometers, or for use with Dakota Digital instruments: Includes electric servo, mounting hardware, wiring harness and choice of control handle. Compatible with 2,000 to 40,000 pulse per mile speed signals. Dakota Digital instruments use 8K ppm signals.

**CRS-3000 each . . . . . 245.00**

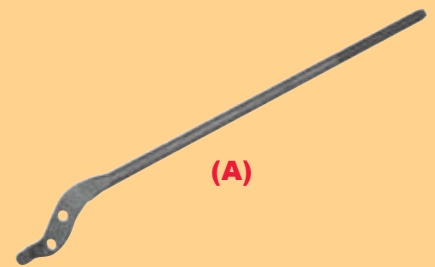

## Front Suspension Lower Arm Strut

- 1968-69 Fairlane, Comet and Montego  
**Right hand** - (Stock # B03-4140-015)  
**OEM # C8OZ-3468-A each . . . . . 179.95**
- 1968-71 Fairlane and Torino  
1968-69 Comet and Montego  
**Left hand** - (Stock # P03-4140-025) **OEM # C9ZZ-3468-D each . . . . . 99.95** (A)
- 1970-71 Fairlane and Torino  
1970 Comet  
**Right hand** - (Stock # P03-4140-02)  
**OEM # C9ZZ-3468-C each . . . . . 69.95**

# 1962-72 Fairlane



## Lower Strut Rod Nuts

Oval lock nuts exactly like original.  
 $\frac{1}{16}$ -18 x  $1\frac{1}{8}$ " and  $\frac{1}{16}$ -18 x 1"

1970-71 Fairlane and Torino  
 (Stock # P03-4140-030)

**Price  
 Reduced!**

**OEM # C9ZZ-3468-N pair . . . . . 14.95**



## Steering Wheel Collar

Chrome plated. Fits on the back side of the optional wood grain wheel.

1967 Fairlane

(Stock # B03-4160-025)

**Price  
 Reduced!**

**OEM # C7OZ-3491-A each. . . . . 37.95**



## Rebuilt Steering Gearbox

**Must have core for exchange!**

We can rebuild almost any gearbox. Send us your complete, re-buildable core and we'll completely disassemble, clean, inspect and repair any problems. Include your daytime phone number, so we may contact you if necessary. The usual turn around is 3 weeks from the date we receive your gearbox.

1962-71 Fairlane

(Stock # B03-3965-200)

**OEM # C2OZ-3504-RR each . . . 259.95**



**Save on shipping by watching for our Free Freight e-mails. You can join our e-mail club at [www.ClassicAutoParts.com](http://www.ClassicAutoParts.com)**

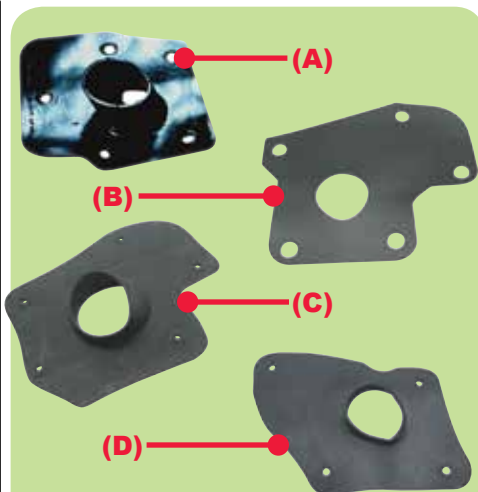

## Steering Column to Floor Seal

1962-65 Fairlane

(Stock # B03-4235-075)

**(A)**

**OEM # C2OZ-3513 each . . . . . 29.95**

1966-67 Fairlane and Comet

(Stock # B03-4235-085)

**(B)**

**OEM # C6OZ-3513 each . . . . . 6.95**

1968-69 Fairlane/Torino/Comet/Montego

(Stock # B03-4235-105)

**(C)**

**OEM # C8OZ-3513 each . . . . . 19.95**

1970-71 Fairlane/Torino/Comet/Montego

(Stock # B03-4235-115)

**(D)**

**OEM # D0OZ-3513 each . . . . . 19.95**



## Steering Column Bushing

$\frac{3}{4}$ " ID x  $\frac{13}{16}$ " OD

1964-70 Fairlane - power steering

(Stock # S03-4250-050)

**OEM # C7SZ-3517-D each . . . . . 27.95**



## Steering Column Upper Bearing Sleeve

1" OD x  $\frac{3}{4}$ " ID

1960-67 Fairlane - manual steering

1965-67 Comet - without flange

(Stock # P03-4255-005)

**(A)**

**OEM # B1AZ-3518-A each. . . . . 5.95**

1964-67 Fairlane - with power steering

(Stock # P03-4295-020)

**OEM # D5AZ-3D527-A each . . . . . 5.95**



## Power Steering Hydraulic Ball Stud Repair Kit

Consists of seats, spring, bumper, clamp, stud, cover, seals and screws.

1962-71 Fairlane/Torino

(Stock # P03-4325-045) - steel bushings **(A)**

**OEM # C2AZ-3A533-A kit . . . . . 19.95**

(Stock # P03-4325-050) - bronze bushings

**OEM # C2AZ-3A533-SK kit **Price Reduced!** . . . . . 78.00**



## Power Steering Spool Valve Rebuilding Kit

Includes input shaft dust cover, 2 seals, 2 snap rings, sector shaft bushing, cover, and spacer. Piston ring back-up o-ring, valve housing seal, sector shaft cover seal, and piston ring Teflon seal.

1965-72 Fairlane and Torino

1966-71 Comet, Montego, and Cyclone

(Stock # P03-4340-020)

**OEM # D1AZ-3A538-ER each . . . . 8.95**



## Steering Gear Bearing Cup

Fits upper and lower

1962-64 Fairlane

1966-71 Comet, Montego and Cyclone

(Stock # P03-4405-010)

**OEM # C2AZ-3552-A each. . . . . 14.95**



## Linkage Stop Insulator

Power steering control valve linkage stop insulator. Requires 2.

1962-65 Fairlane

(Stock # P03-4445)

**OEM # C1AA-3C562-A each . . . . . 3.95**

Steering Parts

# 1962-72 Fairlane

Steering Parts



## Steering Column Lower Flange Insulator

For steering gear without flange.

1965-67 Fairlane

(Stock # B03-4455-005)

**Price Reduced!**

**OEM # C6OZ-3B564-A each . . . . . 9.95**



## Steering Gearbox Worm Bearing and Race

1962-71 Fairlane and Torino

(Stock # P03-4475-110)

**OEM # C2AZ-3571-A each . . . . . 59.95**



## Sector Shaft Bushing

This is the steering gear housing sector shaft bushing.

**Lower**

1962-71 Fairlane and Torino

1966-71 Comet and Montego

1972 Torino - manual steering

(Stock # P03-4495-050)

**OEM # C1AZ-3576-B each . . . . . 7.95**

**Upper**

1966-71 Fairlane/Torino/Comet/Montego

(Stock # C03-4495-060)

**OEM # C4DZ-3576-B each . . . . . 24.95**



(A)

## Power Steering Pump Seal and Gaskets

1962-65 Fairlane - with Eaton pump

(Stock # S03-4530-015)

**OEM # C2SZ-3B584-A kit . . . . . 17.95**

(A)

1965-72 Fairlane and Torino - with Ford® pump

(Stock # P03-4530-025)

**OEM # D1AZ-3B584-A kit . . . . . 13.95**



## Power Steering Pump Seal and Gasket Super Kits

These kits include numerous o-rings, shaft seals, filter seat seals, housing cover gaskets, stud washers, cover bolt grommets, and pressure adapter seals. Parts will vary with different pumps and applications.

1962-72 Fairlane and Torino

1966-71 Comet, Montego and Cyclone

(Stock # S03-4530-055)

**OEM # C2SZ-3C584-BC kit . . . . . 19.95**

1972 Torino - Saginaw vane pumps

(Stock # M03-4530-045)

**OEM # D2VY-3B584-BC kit . . . . . 18.95**



## Pitman Arm

**Price Reduced!**

1966-71 Fairlane - manual steering

(Stock # B03-4555-056)

**OEM # C8OZ-3590-A each . . . . . 292.95**



## Steering Shaft Oil Seal

**Fits 1 1/8" sector shaft only**

1962-71 Fairlane and Torino

1966-70 Comet and Montego

(Stock # P03-4560-010)

**OEM # 8A-3591 each . . . . . 3.95**



## Power Steering Pump Rotor Shaft Oil Seal

**Eaton pump, belt driven and side mounted**

1960-65 Fairlane

1962-63 Meteor

(Stock # S03-4565)

**OEM # C2SZ-3B592-A each . . . . . 18.95**

**For Ford® pump**

1965-72 Fairlane and Torino

1966-72 Comet, Montego and Cyclone

(Stock # P03-4565-005)

**OEM # C5AZ-3B592-C each . . . . . 15.95**



## Woodgrain Steering Wheel

This is a 3 spoke wheel that is a reproduction of the original pony interior simulated wood wheel. It includes the horn ring, contact plates and hardware. This wheel was also option on standard interior cars. Horn center cap sold separately.

1967 Fairlane

(Stock # B03-4590-104)

**OEM # C7OZ-3600-AJ each . . . . . 299.95**



## Steering Wheel

Standard 2-spoke wheel

1968-69 Fairlane

**Black** - (Stock # C03-4590-106)

**Price Reduced!**

**OEM # C8AZ-3600-A each . . . . . 169.95**

**Blue** - (Stock # P03-4590-107)

**OEM # C8AZ-3600-B each . . . . . 249.95**

**Dark Red** - (Stock # P03-4590-108)

**OEM # C8AZ-3600-C each . . . . . 249.95**

**Ivy gold** - (Stock # P03-4590-109)

**OEM # C8AZ-3600-D each . . . . . 239.95**



## Power Steering Hose Mounting Insulator

1962-66 Fairlane

(Stock # B03-4620-010)

**OEM # C2OZ-3A609-A each . . . . . 5.95**

1966 Fairlane - 390

1967-71 Fairlane and Torino

1966-69 Comet and Montego - 390

(Stock # P03-4620-020)

**OEM # C7ZZ-3A609-A each . . . . . 6.95**

# 1962-72 Fairlane



## Steering Column Upper Bearing Retainer

Fixed wheel - key lock retainer  
1970 Fairlane/Comet - Montego/Cyclone  
(Stock # P03-4625-020)  
**OEM # D0AZ-3C610-A each . . . . . 1.95**



## Steering Wheel Pad

Black - for 3 spoke wheels  
1969-71 Fairlane  
(Stock # P03-4660-019)  
**OEM # C9AZ-3623 each. . . . . 119.95**



## Rimblow Steering Wheel Pad

Correct Corinthian grain with a soft, padded feel. Pad only, emblems not included.  
1970 Torino and Ranchero  
(Stock # B03-4650-005)  
**OEM # D3OZ-3623-BAK each . . . 95.95**



## Steering Wheel Rim Cover

Black - for 3 spoke wheel  
1969-71 Fairlane  
(Stock # P03-5077-080)  
**OEM # C9ZZ-3752-A each . . . . . 159.95**

**Price Reduced!**



## Steering Wheel Emblem

For the 3 spoke wheel. Original colors with black background. Beautiful piece.  
1969 Fairlane  
(Stock # P03-4665-074)  
**OEM # C9AZ-3627-A each. . . . . 0.00**



## Steering Wheel Emblem

For the 3 spoke wheel. Original colors with black background. Beautiful piece.  
1970 Fairlane  
(Stock # P03-4665-078)  
**OEM # D0AZ-3627-A each . . . . . 0.00**



## Horn Panel Pad

Black only - can be dyed to match interior.  
1968-69 Fairlane  
(Stock # P03-4670-050)  
**OEM # C8AZ-3629-A each. . . . . 28.95**



## Oil Reservoir Cap Gasket

1962 Fairlane - 8 cylinder  
1963-65 Fairlane - all  
(Stock # P03-4715-005)  
**OEM # C0AA-3A642-B each . . . . . 3.95**



## Horn Ring Emblems

1962-64 Fairlane 500  
(Stock # B03-4745-005)  
**OEM # C2OZ-3649-A each. . . . . 35.95**  
1963 Fairlane - Sports Coupe  
(Stock # B03-4745-010)  
**OEM # C3OZ-3649-B each. . . . . 36.95**

# 1-800-654-3247



## Power Steering Control Valve and Ball Stud Repair Kit

This is a super kit including 1 ball stud, 2 stud seats, an aluminum stop plug, a ball stud rubber spaces, dust boot and clamp, 2 clamp screws, 1 bronze bushing, seal bushings, 2 thick bumper spool stops, cap gasket, 2 valve plug o-rings, housing gaskets, adjusting nut and 2 thin bumper spool stops.  
1962-72 Fairlane and Torino  
1966-71 Comet, Montego and Cyclone  
(Stock # P03-4750-025)  
**OEM # C2AZ-3A650-SK each. . . . . 46.95**



## Power Steering Hydraulic Control Valve Repair Kit

This is the soft parts only. Includes gaskets, nuts, o-rings, rubbers & bushings.  
1963-71 Fairlane and Torino  
1966-71 Comet and Montego  
(Stock # P03-4750-030)  
**OEM # C3AZ-3A650-B each. . . . . 13.95**



## Power Steering Piston Boot and Insulator Kit

Kit includes: 2 washers, 2 insulators, 1 clamp, and 1 boot.  
1964-67 Fairlane & 1966-71 Comet/Montego  
(Stock # P03-4755)  
**OEM # C3AZ-3C651-A kit . . . . . 11.95**



## Steering Wheel Upper Collar

1967 Fairlane - with woodgrain wheel  
(Stock # B03-4770-200)  
**OEM # C7OZ-3656-A each. . . . . 39.95**

Steering Parts

# 1962-72 Fairlane

Steering Parts



## Key Blanks

- 1962-64 Fairlane (A)  
(Stock # P03-4880-045) - ignition/door  
**OEM # BA-3685-A each . . . . . 2.95**  
(Stock # P03-4880-050) - trunk  
**OEM # BA-3685-B each . . . . . 3.95**  
1965-72 Fairlane and Torino (B) Price Reduced!  
(Stock # P03-4880-065) - ignition  
**OEM # C7AZ-3685-A each . . . . . 2.95**  
(Stock # P03-4880-070) - trunk  
**OEM # C7AZ-3685-B each . . . . . 4.95**



## Anniversary Key Blank

- Has the multi-colored Ford® crest in the key.  
1962-64 Fairlane Price Reduced!  
(Stock # P03-4880-046)  
**OEM # BA-3685-ANV each . . . . . 15.95**



## Power Steering Return Hose

- Control valve to pump  
1967 Fairlane - 390 and 427  
1968-69 Fairlane - 390  
1969 Fairlane - 302, 351 and 428  
1970-71 Torino - 8 cylinder  
(Stock # B03-4965-055)  
**OEM # C8OZ-3A713-B each . . . . . 15.95**  
1967-68 Fairlane - 170 and 200  
1969 Fairlane - 250  
1966-68 Comet - 6 cylinder  
1969 Comet - 6 cylinder and 250 Price Reduced!  
(Stock # B03-4965-035)  
**OEM # C7OZ-3A713-A each . . . . . 21.95**  
1967-68 Fairlane - 289 and 302 Price Reduced!  
(Stock # B03-4965-040)  
**OEM # C7OZ-3A713-C each . . . . . 32.95**

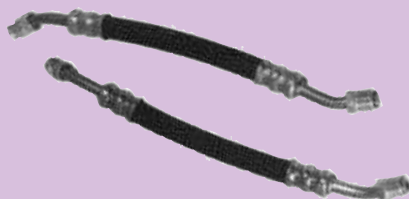

## Power Steering Control Valve to Cylinder Hoses

- 1966-71 Fairlane/Torino Price Reduced!  
(Stock # B03-4970-025)  
**OEM # C6OZ-3A714/17-A pair . . 54.95**



## Steering Column Lock Insert

- 1970-72 Fairlane/Torino  
(Stock # P03-4980-005)  
**OEM # D0AZ-3E716-A each . . . . . 4.95**



(A)

## Power Steering Pressure Hose

- Pump to control valve  
1967 Fairlane - 289 V-8  
(Stock # B03-4995-065) (A)  
**OEM # C6OZ-3A719-D each . . . . . 39.95**  
1967 Fairlane - 6 cylinder Price Reduced!  
1967 Comet - 6 cylinder  
(Stock # B03-4995-070)  
**OEM # C7OZ-3A719-A each . . . . . 56.95**  
1967 Fairlane - 390 and 427  
1967 Comet - 390 and 427 without air  
(Stock # B03-4995-075)  
**OEM # C7OZ-3A719-B each . . . . . 37.95**  
1967 Fairlane - 289  
1967 Comet - 289  
(Stock # B03-4995-080)  
**OEM # C7OZ-3A719-C each . . . . . 38.95**  
1968-69 Fairlane - Big Block without air  
(Stock # B03-4995-095) Price Reduced!  
**OEM # C8OZ-3A719-B each . . . . . 29.95**  
1970-71 Fairlane and Torino - 302 and 351  
(Stock # B03-4995-085) Price Reduced!  
**OEM # D0OZ-3A719-E each . . . . . 24.95**



## Power Steering Pump Pulley

- Single groove pulley. Fits many applications.  
(Stock # P03-5050-020) - 5 1/4" OD  
**OEM # C7AZ-3A733-A each . . . . . 79.95**



## Power Steering Control Valve Ball Stud Socket

- 1962-71 Fairlane and Torino  
1966-71 Comet and Montego  
(Stock # P03-5090)  
**OEM # C1AA-3A754-C each . . . . . 26.95**



## Power Steering Cylinder Seal Kit

- Kit includes 1 spacer, 1 bushing, 3 seals, 1 scraper, and 1 ring.  
1962-71 Fairlane  
(Stock # P03-5105-005)  
**OEM # C1AZ-3A764-A each . . . . . 17.95**



## Power Steering Cylinder Super Seal Kit

- 1962-65 Fairlane  
1966 Comet (A)  
(Stock # P03-5105-010)  
**OEM # C1AZ-3A764-C each . . . . . 29.95**  
1966-72 Fairlane  
1967-71 Comet and Montego  
(Stock # P03-5105-015)  
**OEM # C6AZ-3A764-C each . . . . . 22.95**



# 1962-72 Fairlane



## Power Steering Gear Piston Seal

1972 Fairlane  
(Stock # P03-5145) - 3 $\frac{1}{2}$ " ID  
**OEM # C5AZ-3805-A each . . . . . 7.95**

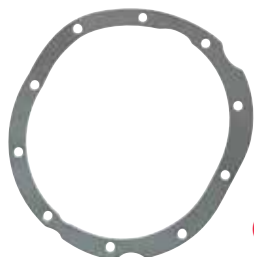

## Rear Axle Housing Gasket

**For 9" rear end**  
1962-71 Fairlane and Torino  
1966-70 Comet and Montego - 9" and 9 $\frac{5}{8}$ " ring gear  
(Stock # P04-6095-045) **(A)**  
**OEM # B7A-4035 each . . . . . 5.95**  
**For 8" rear end**  
1962-71 Fairlane and Torino  
1966-70 Comet and Montego  
(Stock # B04-6095-055)  
**OEM # C9OZ-4035-A each . . . . . 7.95**



## Ring Gear and Pinion Set

3.25:1 gear ratio - 9" ring gear  
1966-72 Fairlane  
(Stock # P04-6245-100)  
**OEM # B8AZ-4209-C set . . . . . 419.95**



## Differential Pinion Shaft

2 pinion differential for 7 $\frac{3}{4}$ ", 8", 8 $\frac{3}{4}$ ", and 9" ring gear. Includes 1 shaft and 1 pin.  
1962-71 Fairlane and Torino  
1966-70 Comet and Montego  
(Stock # P04-6255-020)  
**OEM # B7AZ-4211-A each . . . . . 29.95**



## Differential Bearing

**1 $\frac{1}{2}$ " ID**  
1962-64 Fairlane - 7 $\frac{1}{4}$ " ring gear  
1967-68 Fairlane - small bearing  
1966-68 Comet and Montego - 7 $\frac{1}{4}$ " ring gear  
(Stock # F04-6280-055)  
**OEM # C1UW-4221-A each . . . . . 23.95**  
**1 $\frac{5}{8}$ " ID**  
1962-70 Fairlane - medium bearing  
1965-72 Comet and Montego - 7 $\frac{3}{4}$ " and 8" ring gear  
(Stock # P04-6280-035) **(A)**  
**OEM # B7A-4221-A each . . . . . 12.95**  
**1 $\frac{25}{32}$ " ID**  
1962-70 Fairlane - large bearing  
1966-70 Comet and Montego - 9" ring gear  
(Stock # P04-6280-040)  
**OEM # B7A-4221-B each . . . . . 12.95**  
1970-71 Fairlane and Torino - from 5/13/70 - 9" ring gear  
1970-71 Comet and Montego - 9" ring gear  
(Stock # P04-6280-060)  
**OEM # C9AZ-4221-A each . . . . . 19.95**



## Differential Bearing Cup

**2 $\frac{1}{16}$ " OD**  
1962-64 Fairlane  
1967-68 Fairlane  
1966-68 Comet - 260 and 289 - 24 spline shaft only  
(Stock # F04-6285-050)  
**OEM # C1UW-4222-A each . . . . . 15.95**  
**2 $\frac{57}{64}$ " OD**  
1966-71 Comet and Montego  
(Stock # P04-6285-035)  
**OEM # B7A-4222-A each . . . . . 7.95**  
1970-72 Fairlane and Torino  
1970-71 Comet and Montego - 9" ring gear  
(Stock # P04-6285-055)  
**OEM # C9AZ-4222-A each . . . . . 8.95**



## Differential Side Gear Washer

Rear axle differential side gear thrust washer.  
1965-70 Fairlane  
1969-72 Comet, Montego and Cyclone - 7 $\frac{3}{4}$ ", 8", 8.7", 9" and 9 $\frac{5}{8}$ " ring gears  
(Stock # B04-6295-020)  
**OEM # C9OZ-4228-A each . . . . . 5.95**



## Rear Axle Differential Pinion Thrust Washer

1972 Fairlane  
(Stock # P04-6300-025)  
**OEM # D0AZ-4230-A each . . . . . 3.95**



## Driving Pinion Bearing Cup

1962-71 Fairlane - 7 $\frac{3}{4}$ " and 8" ring gear  
1966-70 Comet - all  
(Stock # X04-6530-055)  
**OEM # C0DW-4616-A each . . . . . 9.95**  
1963-71 Fairlane - 8 $\frac{3}{4}$ " and 9" ring gear - front or rear, 28 spline shaft  
1967-71 Fairlane - 9" ring gear - front, 31 spline shaft  
(Stock # P04-6530-035) **Price Reduced! (A)**  
**OEM # B7A-4616 each . . . . . 9.95**  
1964-72 Fairlane - except 8" ring gear  
(Stock # F04-6530-100)  
**OEM # TBAA-4616-A each . . . . . 19.95**



## Driving Pinion Bearing Cone and Roller Assembly

Fits both front and rear.  
1962-64 Fairlane  
(Stock # P04-6535-040) **(A)**  
**OEM # B7A-4621-A each . . . . . 25.95**  
1962-72 Fairlane and Torino  
1966-70 Comet  
(Stock # X04-6535-055)  
**OEM # C0DW-4621-A each . . . . . 19.95**



# 1962-72 Fairlane



## Differential Pinion Pilot Bearing

1.10" ID - 2<sup>1</sup>/<sub>2</sub>" thick

1962-72 Fairlane and Torino  
1966-70 Comet and Montego - 9" ring gear

(Stock # P04-6540-025)

**OEM # C2AZ-4625-B each . . . . . 43.95**

7<sup>3</sup>/<sub>4</sub>" and 8" ring gear

1962-72 Fairlane and Torino  
1966-70 Comet and Montego - 8" ring gear

(Stock # B04-6540-030)

**OEM # C2OZ-4625-B each . . . . . 39.95**



## Driving Pinion Pilot Bearing Retainer

1962-71 Fairlane and Torino - 8<sup>3</sup>/<sub>4</sub>" or 9" ring gear

1966-70 Comet and Montego

(Stock # P04-6550)

**OEM # B7AZ-4627-A each . . . . . 33.95**



## Driving Pinion Bearing Cup

1962-64 Fairlane

(Stock # X04-6555-005)

**OEM # CODW-4628-A each . . . . . 15.95**



## Driving Pinion Bearing Cone and Roller Assembly

1962-64 Fairlane - 6<sup>3</sup>/<sub>4</sub>" ring gear

1962-63 Fairlane - 7<sup>1</sup>/<sub>4</sub>" ring gear

(Stock # X04-6565-015)

**OEM # CODW-4630-A each . . . . . 18.95**

1964-68 Fairlane - 7<sup>1</sup>/<sub>4</sub>" ring gear

(Stock # B04-6565-100)

**OEM # C1DZ-4630-A each . . . . . 51.95**



## U-Joint Assembly

We have several u-joints on hand but their applications overlap greatly so we are listing the original OEM numbers. For applications give us a ring and we can see if we have what you're looking for.

(Stock # P04-6575-015)

**OEM # C3AZ-4635-C each . . . . . 14.95**

(Stock # P04-6575-020)

**OEM # C3AZ-4635-D each . . . . . 14.95**

(Stock # P04-6575-025)

**OEM # C3AZ-4635-E each . . . . . 14.95**

(Stock # P04-6575-030)

**OEM # C3AZ-4635-F each . . . . . 14.95**

(Stock # P04-6575-035)

**OEM # C3AZ-4635-G each . . . . . 14.95**

(Stock # P04-6575-040)

**OEM # C3AZ-4635-H each . . . . . 19.95**



## Rear Axle Pinion Bearing Spacer

Also called the crush collar.

1962-71 Fairlane - 8<sup>3</sup>/<sub>4</sub>" or 9" ring gear

1966-72 Comet and Montego

(Stock # P04-6605)

**OEM # B7A-4662-A each . . . . . 8.95**

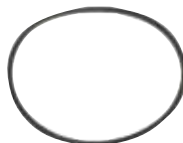

## Driving Pinion Bearing Retainer "O" Ring

1962-71 Fairlane

(Stock # P04-6610-005) - 4<sup>3</sup>/<sub>4</sub>" long

**OEM # B7A-4669-B each . . . . . 2.95**

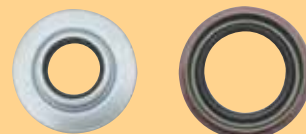

## Driving Pinion Oil Seal

1962-67 Fairlane - 7<sup>1</sup>/<sub>4</sub>" or 8" ring gear  
(Stock # B04-6630-051)

**OEM # C2OZ-4676-B each . . . . . 19.95**

1.8" x 3"

1963-64 Fairlane - 289 Special

(Stock # P04-6630-040)

**OEM # C2AZ-4676-A each . . . . . 11.95**

1<sup>1</sup>/<sub>6</sub>" ID - 1/2" thick

1963-71 Fairlane - 9" ring gear

(Stock # P04-6630-030)

**OEM # B8A-4676-B each . . . . . 9.95**

Double lip seal - will not fit WER axle!

1965-70 Fairlane

(Stock # P04-6630-045)

**OEM # C2AZ-4676-B each . . . . . 10.95**



## Rear Axle Differential Clutch Plate

Traction Lock Axles 4<sup>7</sup>/<sub>8</sub>" OD x 3<sup>3</sup>/<sub>4</sub>" ID with 46 spines, .062" thick.

1968-72 Fairlane

(Stock # B04-6785-010)

**OEM # C8OZ-4945-B each . . . . . 22.95**



## Differential Clutch Plate

Steel plate

1968-72 - 9" rear end with traction lock

(Stock # B04-6795-005)

**OEM # C8OZ-4947-A each . . . . . 13.95**

Don't forget to join our e-mail list. We send out e-mail specials, and you don't want to miss out!



# 1962-72 Fairlane

Frame Parts

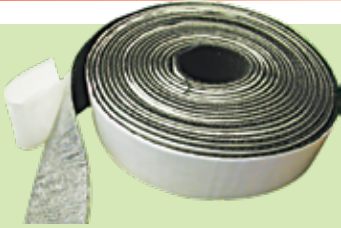

## Adhesive Body to Frame Webbing "Anti-Squeak"

This is a special body cushion with pressure sensitive adhesive on the back side designed to go between your body and your frame.

- 20 Ft. long x 1½" wide**  
(Stock # V05-7000-025) **Price Reduced!**  
**OEM # B-5000-AS roll . . . . . 26.95**
- 20 Ft. long x 2" wide**  
(Stock # V05-7000-030) **Price Reduced!**  
**OEM # B-5000-BS roll . . . . . 26.95**



## Body to Frame Shims

**2" X 1½" with 5/8" slot**  
1962-72 Fairlane and Torino  
1966-71 Comet and Montego  
(Stock # V05-7000-045) - **package of 10**  
**OEM # B-5000-SHK pkg. . . . . 6.95**



**Special ORDER**

## Sub Frame Connectors

1966-67 Fairlane and Ranchero - Hardtop  
1966-67 Cyclone - Hardtop  
(Stock # B05-7020-300)  
**OEM # C60Z-5005-ASPO each . 269.95**  
1966-67 Fairlane and Cyclone Convertible  
(Stock # B03-7020-200)  
**OEM # C60Z-5005-BSPO each . 299.95**

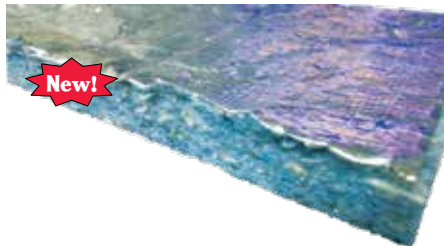

**New!**

## Felt and Foil Insulation

**4' x 5' roll**  
(Stock # V05-7040-003)  
**OEM # B-5010-FI roll . . . . . 31.95**



**Best Seller!**

## Noise and Heat Insulation Material

Reflective foil insulation consists of two layers of polyethylene bubble film sandwiched between two layers of pure aluminum foil, making a structure 5/16" thick. Temperature range of -60°F to 180°F. Works great for insulating firewalls, headliners, floor pans, trunk area, door panels, kick panels, rumble seat area, etc. Cut and form into needed shapes using scissors and contact cement or weather strip adhesive.

**48" x 72" x 5/16"**  
(Stock # R05-7040-015)  
**OEM # SR-5010-5 each . . . . . 26.95**



## Body to Frame Insulation Sheeting

**3' wide by 8' long x 1/16" thick roll**  
We recommend using spray-on adhesive for easy installation. Tar paper style.  
(Stock # V05-7040)  
**OEM # B-5010-F30 roll . . . . . 8.95**



## Body Insulation Sheeting

This is a heat resistant, waterproof, sound deadening material that fits under the headliner, carpet, door panels, firewall, etc. It has a self-adhesive backing for easy installation and non-slip coverage. High density rubber.

**32" x 50" sheet**  
(Stock # V05-7040-005)  
**OEM # B-5010-FSS each . . . . . 36.95**



**New!**

## Exhaust Tips

Polished stainless steel  
1969 Torino and Cyclone - big block  
(Stock # B05-7580-035)  
**OEM # C90Z-5263-A each. . . . 229.95**  
1970-71 Torino and Cyclone - big block  
(Stock # B05-7580-048)  
**OEM # D00Z-5263-A each . . . 229.95**



**Special ORDER**

## Shock Tower Kit

For extra clearance for Big and Small block engines. Detailed installation instructions included.  
1962-65 Fairlane  
(Stock # B05-7645-063)  
**OEM # C20Z-5310-SPO each . . 279.95**



**Special ORDER**

## Shock Tower Lower Brace

Replace the curved tube for header clearance.  
1962-65 Fairlane  
(Stock # B05-7647-010)  
**OEM # C20Z-5311-LBSP0 each . 89.95**



**Special ORDER**

## Shock Tower Export Brace

Braces towers to the firewall.  
1962-65 Fairlane  
(Stock # B05-7647-015)  
**OEM # C20Z-5311-SPO each . . 159.95**

# 1962-72 Fairlane

Frame Parts



side view

## Coil Spring Insulator

1966-72 Fairlane/Comet/Montego  
(Stock # C05-7730-015)

OEM # C4DZ-5415-A each . . . . . 2.95



## Stabilizer Bar End Kit

Includes 4 insulators, 4 washers, 1 nut and washer set, and 1 spacer. Requires 2 kits.

1962-71 Fairlane and Torino  
1966-67 Comet - before 12/30/66  
1968 Comet and Montego - except GT  
1969-71 Comet and Montego  
(Stock # B05-7830-110) - front

OEM # C2OZ-5A486-A kit . . . . . 14.95



## Stabilizer Bar Bushing

.66" ID

1963-64 Fairlane  
(Stock # P05-7855-035)

OEM # B9A-5493-B each . . . . . 6.95

For 1/16" bar

1966-68 Fairlane  
(Stock # X05-7855-062)

OEM # C6OZ-5493-B each . . . . . 27.95

For 7/8" bar

1966-71 Fairlane and Torino  
1966-71 Comet and Montego  
(Stock # B05-7855-060)

OEM # C6OZ-5493-E each . . . . . 15.95

For 3/4" bar

1966-71 Fairlane  
(Stock # B05-7855-066)

OEM # C7OZ-5493-C each . . . . . 14.95

1969-72 Fairlane and Torino  
(Stock # P05-7855-070)

OEM # C9AZ-5493-A each . . . . . 0.00



## Rear Spring Insulator

1972 Torino  
(Stock # P05-7875)

OEM # C9AZ-5536-A each . . . . . 11.95



## Rear Spring Relocation Kit

This total of 6" clearance allows for larger rear tires. This kit moves the springs inward on the axel housing.

Special Order ONLY!

1966-69 Fairlane and Comet  
(Stock # B05-7880-070)

OEM # C6OZ-5560-AK kit . . . . . 338.95



## Black Leaf Spring Poly

This is a black poly material used between leaves of spring to eliminate squeaking.

2 1/4" x 20'

(Stock # Z05-7880-285)

OEM # U-5560-PA roll . . . . . 9.95

2" x 20'

(Stock # Z05-7880-290)

OEM # U-5560-PB roll . . . . . 19.95



## Anti-Squeak Pad

For rear leaf springs - molded plastic

1963-64 Fairlane  
(Stock # P05-7885-005)

OEM # B8A-5586-A each . . . . . 1.95

1968-72 Fairlane - requires 12  
(Stock # P05-7885-010)

OEM # C0AA-5586-B each . . . . . 2.95



## Rear Spring Clamp

1962-66 Fairlane - with 2" springs  
(Stock # C05-8000-030)

OEM # C4DZ-5724-B each . . . . . 4.95

1967-71 Fairlane - with 2 1/2" springs (A)  
(Stock # C05-8000-025)

OEM # C4DZ-5724-A each . . . . . 11.95



## Rear of Rear Spring Shackle Kit

Includes shackle bar, bushings and bolts. Requires 2 kits per car.

1962-65 Fairlane  
(Stock # B05-7895-110)

OEM # C2OZ-5630-C kit . . . . . 71.95

1966-69 Fairlane and Torino  
1966-69 Comet

1970-71 Torino and Montego  
(Stock # B05-7895-175)

OEM # D1OZ-5630-A each . . . . . 44.95

1966-72 Fairlane and Torino  
1966-69 Comet and Montego  
(Stock # B05-7895-135)

OEM # C6OZ-5630-A each . . . . . 69.95

1966-72 Station Wagon only  
(Stock # X05-7895-130)

OEM # C6DZ-5630-A kit . . . . . 0.00

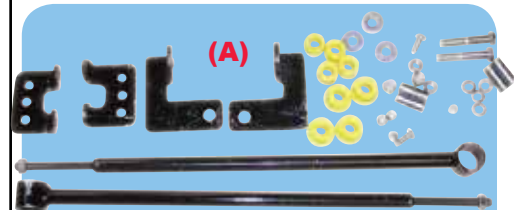

## Rear Traction Bar Kit

Includes polyurethane bushings and brackets

1964-66 Fairlane  
(Stock # B05-8025)

OEM # C4OZ-5750-K kit . . . . . 199.95

1967-72 Fairlane  
(Stock # B05-8025-005)

OEM # C7OZ-5750-K kit . . . . . 171.95



## Rear Leaf Spring Bushing

1/2" diameter hole

1965-71 Fairlane  
(Stock # X05-8050-073)

OEM # C4DZ-5781-C each . . . . . 19.95

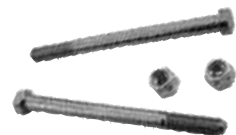

## Leaf Spring Eye Bolt Set

Complete with nuts  
1971 Ranchero and Fairlane 429CJ  
(Stock # P05-8050-085)

OEM # C5ZZ-5781-A kit . . . . . 17.95

# 1962-72 Fairlane



## Engine Dress-Up Kit

This puts some real "shine" under the hood! Contains baffled valve covers, mini tabs, wing nuts, push in breathers, breather grommets, and valve cover grommet. Fits Small Block Fords 1962-72 **Price Reduced!**  
 (Stock # B06-10000-040)  
**OEM # C2OZ-6000-EDK kit . . . . 184.95**

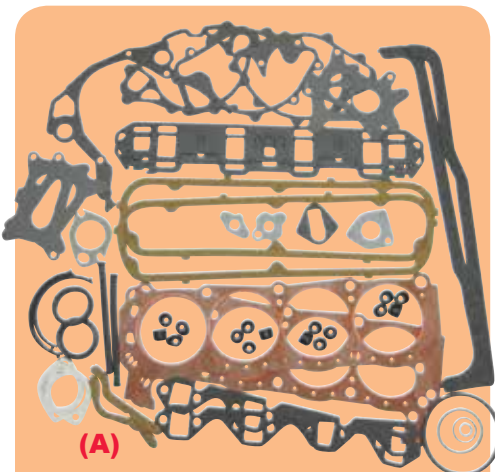

## Complete Engine Gasket Set

1962 Fairlane - 292 **Price Reduced!**  
 (Stock # P06-10020-065)  
**OEM # B7AZ-6008-F set . . . . . 146.95**  
 1962-64 Fairlane - 170, 200  
 (Stock # X06-10020-080)  
**OEM # CODZ-6008-C set . . . . . 139.95**  
 1962-68 Fairlane - 260, 289 and 302  
 (Stock # B06-10020-090) **(A)**  
**OEM # C2OZ-6008-E set . . . . . 158.95**  
 1962-71 Fairlane - 332, 352, 390, 406,  
 427 and 428  
 (Stock # P06-10020-085)  
**OEM # C2AZ-6008-D set . . . . . 136.95**  
 1969-72 Fairlane - 250, 6 cylinder  
 (Stock # B06-10020-110)  
**OEM # C9OZ-6008-A set . . . . . 87.95**  
 1969-78 Fairlane - 351W  
 (Stock # P06-10020-125)  
**OEM # D1AZ-6008-C set . . . . . 108.95**

**Please allow 7-14 days for Special Orders!**



## Head to Block Down Pin

Split Type  
 1962-71 Fairlane - small block  
 (Stock # B06-10020-145)  
**OEM # C2OZ-6A008-A each . . . . . .95**

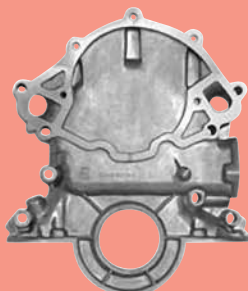

## Timing Chain Cover

With cast aluminum timing pointer as original. Cast aluminum machine dip stick tube hole - plug also included. Crankshaft seal installs from front side. Clears crankshaft mounted oil slinger used on early engines. Precision machined to factory specs.  
 1962-66 Fairlane - 2V Man Trans - 289, 302 and 351W - early '64-65 must use only with cast iron water pump **Price Reduced!**  
 (Stock # P06-10050-030)  
**OEM # C4AZ-6019-B each . . . . . 139.95**



## Timing Pointer

1962 Meteor - 221  
 1962-63 Fairlane - except power steering - 221 and 260  
 1962-64 Fairlane - 144, 170 and 200  
 (Stock # B06-10060-020) **(A)**  
**OEM # C2OZ-6023-B each . . . . . 8.95**  
 Includes screws.  
 1968 Fairlane - 289  
 1968-69 Fairlane - 302  
 1969 Fairlane 302 Special, and 351W  
 (Stock # P06-10060-025) **(B)**  
**OEM # C8AZ-6023-B each . . . . . 9.95**

Check out our Swap Meet Schedule to see when we will be in your area. Maybe even save some on shipping. Call one of the guys for more information!



## Front Motor Mount Brackets

Die stamped steel brackets that are a must for converting a 6 cylinder to an 8 cylinder. Great to replace if they happen to be missing from your car. They will also fit a big block by drilling one extra mounting hole.  
 1964-72 Fairlane - small block  
 (Stock # P06-10075-060)  
**OEM # C5ZZ-6028/9-K pair . . . . . 99.95**

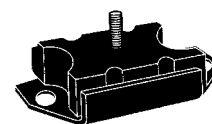

## Front Motor Mount

1962-64 Fairlane - 221, 260, 289 and 289 HI-PO  
 Either side - (Stock # B06-10110-090)  
**OEM # C2OZ-6038-A each . . . . . 47.95**  
 1967-68 Fairlane - 200  
 (Stock # X06-10110-187) **(A)**  
**OEM # C6DZ-6038-E each . . . . . 18.95**  
 1966-69 Fairlane - 390  
 1967-68 Fairlane - 427  
 1968-69 Fairlane - 428  
 1966-69 Comet and Montego - 390, 427 and 428  
 1967-69 Comet and Montego - 428  
 Right hand - (Stock # P06-10110-145)  
**OEM # C5AZ-6038-C each . . . . . 10.95**  
 Left hand - (Stock # P06-10110-150)  
**OEM # C5AZ-6038-D each . . . . . 10.95**  
 1966-69 Fairlane - 390  
 1968 Fairlane - 427 from 11/1/67  
 1968-69 Fairlane - 428  
 Right hand - (Stock # B06-10110-191)  
**OEM # C6OZ-6038-G each . . . . . 18.95**  
 Left hand - (Stock # B06-10110-192)  
**OEM # C6OZ-6038-H each . . . . . 21.95**  
 1966-69 Comet and Montego - 289, 302, 351W  
 1966-71 Fairlane - 289, 302 and 351 Convert  
 Either side - (Stock # B06-10110-265)  
**OEM # D0OZ-6038-D each . . . . . 17.95**

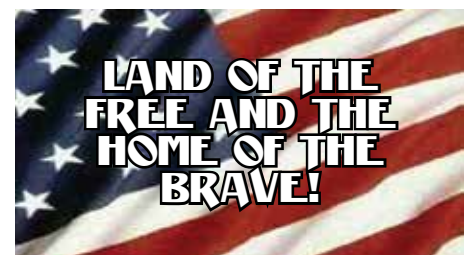

# 1962-72 Fairlane

Motor Parts

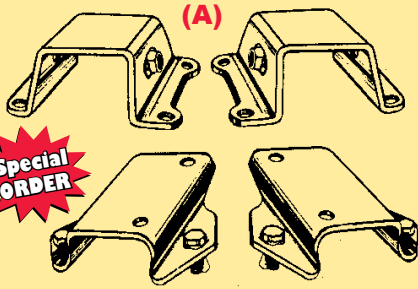

**Special ORDER**

## Engine Conversion Installation Brackets

Special Order ONLY!

This allows you to put a 429 or 460 into the 1966-69 Fairlane, Torino, Comet and Montego.

(Stock # B06-10110-155) **Price Reduced! (A)**

**OEM # C5OZ-6038-ADK set. . . . 499.95**

This allows you to put a 390-427 or 428 - including the pre 1964 FE style - into the 1966-69 Fairlane, Torino, Comet and Montego.

(Stock # B06-10110-195)

**OEM # C6OZ-6038-ADK set. . . . 359.95**

This allows you to put a 302, 351W or 351C into the 1966-69 Fairlane, Torino, Comet and Montego.

(Stock # B06-10110-201)

**OEM # C6OZ-6038-BDK set. . . . 259.95**

This allows you to put a 429 or 460 into the 1970-71 Torino and Cyclone.

(Stock # P06-10110-260)

**OEM # D0AZ-6038-ADK set. . . . 369.95**

This allows you to put a 429 or 460 into a 1972-79 Torino, Ranchero, and Cyclone

(Stock # B06-10110-275) **Price Reduced!**

**OEM # D2OZ-6038-ADK set . . . 299.95**



## Upper Motor Mount

1962-64 Fairlane - 170 and 200

1964 Fairlane - upper donut - HIPO 289

(Stock # B06-10115-025)

**OEM # C2OZ-6039-A each. . . . . 24.95**

**1-800-654-3247**  
**Call Us for**  
**All-American**  
**Deals**



## Head Gasket

1962-63 Fairlane - 221

(Stock # B06-10130-075)

**OEM # C2OZ-6051-C each. . . . . 32.95**



## Transmission Mount

1963-64 Fairlane - 221, 260 and 289 - 4 speed transmission

(Stock # X06-10185-037)

**OEM # C1AA-6068-A each . . . . . 18.95**

1962-64 Fairlane - 170, 200 Auto Trans  
 1962-65 Fairlane - 221, 260 and 289 except 4 speed transmission

(Stock # B06-10185-055)

**OEM # C3OZ-6068-B each. . . . . 19.95**

1966-68 Fairlane - 200 except Convertible  
 1966-68 Fairlane - 289 and 390

1967-68 Fairlane - 427

1968-69 Fairlane - 428

1968-71 Fairlane - 302

1969-71 Fairlane - 351W

**Price Reduced!**

1970-71 Fairlane - 351C

(Stock # B06-10185-082)

**OEM # C8OZ-6068-B each. . . . . 15.95**

1970-71 Fairlane - 351 - except Hardtop and Convertible

1966-70 Comet, Cyclone and Montego - 200, 289, 302, 390, 427, 428 and 429

(Stock # P06-10185-095)

**OEM # D1ZZ-6068-B each. . . . . 0.00**



(A)

## Harmonic Balancer

1962-65 Fairlane - 6 cylinder - single groove

(Stock # X06-10530-067)

(A)

**OEM # C2DZ-6312-A each. . . . . 139.95**

1964-68 Fairlane - 289 - except Hi-Performance

(Stock # P05-10535-001)

**OEM # C5AZ-6316-B each. . . . . 149.95**

1965-67 Fairlane - 352, 390

(Stock # P06-10530-070)

**OEM # C3AZ-6312-A each. . . . . 139.95**



(A)

**Special ORDER**

## Rocker Arm and Shaft Kit

1962 Fairlane - 272, 292

(Stock # P06-10845-005)

(A)

**OEM # B4A-6563-K each. . . . . 509.95**

1962-63 Fairlane - 406

1963-67 Fairlane - 427

(Stock # P06-10845-025) - hydraulic lifters

**OEM # C3AZ-6563-K each. . . . . 231.95**

1965-69 Fairlane - 352, 390, 427

(Stock # P06-10845-035) - mechanical lifters

**OEM # C5AZ-6563-K each. . . . . 799.95**

1965-72 Fairlane - 200, 250

(Stock # B06-10845-045) - hydraulic lifters

**OEM # C5OZ-6563-K each. . . . . 314.95**



## New USA Made Camshafts

1962 Fairlane - 170 - mechanical tappets, cast iron, 14 tooth dist gear - (Stock # X06-10360-045)

**OEM # CODZ-6250-A each. . . . . 139.95**

1962-65 Fairlane - 221, 260 - hydraulic lifters - (Stock # B06-10360-060)

**OEM # C2OZ-6250-A each. . . . . 162.95**

1963-66 Fairlane - 352, 390 - hydraulic lifters - (Stock # P06-10360-065)

**OEM # C3AZ-6250-A each. . . . . 82.95**

1963-71 Fairlane - 289, 302 - hydraulic lifters - (Stock # P06-10360-070)

**OEM # C3AZ-6250-E each . . . . . 59.95**

1966-68 Ranchero - 200 - hydraulic lifters - (Stock # X06-10360-075)

**OEM # C3DZ-6250-A each. . . . . 78.95**

1963-67 Fairlane - 260, 289, 302-4V - mechanical lifters - (Stock # B06-10360-080)

**OEM # C3OZ-6250-C each. . . . . 187.95**

# 1962-72 Fairlane

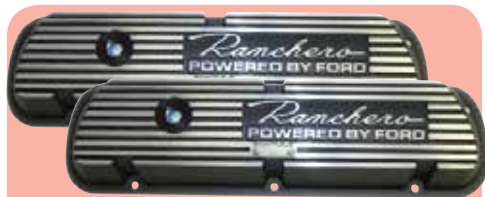

## Aluminum Alloy Valve Covers

Die cast aluminum alloy valve covers inscribed with "Ranchero Powered by Ford®." Fits all small block engines, not EFI. Comes complete with plug wire brackets.

1962-79 Ranchero  
(Stock # X06-10905-030)

**OEM # C2DZ-6582-R/P pair . . . 199.95**



## Aluminum Alloy Valve Covers

Die cast aluminum alloy valve covers inscribed with "Fairlane Powered by Ford®." Fits all small block engines, not EFI. Comes complete with plug wire brackets.

1962-79 Fairlane  
(Stock # B06-10905-055)

**OEM # C2OZ-6582-FL/P pair . . . 199.95**



## Aluminum Alloy Valve Covers

Die cast aluminum alloy valve covers inscribed with "Comet Powered by Ford®." Fits all small block engines, not EFI. Comes complete with plug wire brackets.

1966-70 Comet  
(Stock # X06-10905-035)

**OEM # C2GY-6582-CT/P pair . . . 199.95**

**We have tried to make ordering easy. You can order online with a click of the mouse, or use the order sheets in the back of the catalog. Simply mail or fax over. We'll handle it all from there.**



## Aftermarket Chrome Valve Cover

1962-72 Fairlane and Comet - 221, 260, 289, 302 - except Boss - and 351W  
(Stock # B06-10905-045)

**OEM # C2OZ-6582-CH each . . . 54.95**



## Chrome Valve Cover

After-market style complete with baffle.  
1962-72 Fairlane and Comet - 429 and 460

(Stock # B06-10905-105)

**OEM # C8OZ-6582-A each . . . . . 48.95**

## OEM Style Valve Covers

These valve covers are produced from Ford® factory specifications, making them absolutely perfect reproductions. They feature "Powered by Ford®" stamped on the top with the Ford® blue finish! Sold in pairs.

1968-70 Fairlane - 302 and 351  
(Stock # B06-10905-135)

**OEM # C8OZ-6582-BL pair . . . . . 87.95**



## OEM Style Valve Covers

These valve covers are produced from Ford® factory specifications, making them absolutely perfect reproductions. They feature "Powered by Ford®" stamped on the top and a beautiful chrome finish! Sold in pairs.

1968-70 Fairlane - 302 and 351  
(Stock # B06-10905-155)

**OEM # C8OZ-6582-CH pair . . . . . 125.95**



## Valve Cover Gaskets

1962-72 Fairlane/Torino - 144, 170, 200  
(Stock # X06-10915-007)

**OEM # CODE-6584-B set . . . . . 24.95**

1962-68 Fairlane - 260, 289  
1968-72 Fairlane/Torino - 302  
1969-72 Fairlane/Torino - 351W  
(Stock # B06-10915-015)

**OEM # C2OZ-6584-B set . . . . . 0.00**

1965-72 Fairlane - 240  
(Stock # P06-10915-020)

**OEM # C5AZ-6584-B set . . . . . 18.95**

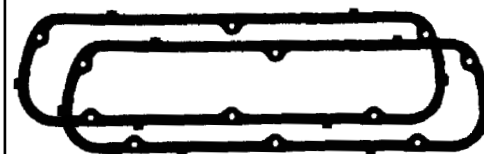

## Steel Core Valve Cover Gaskets

These are not the typical rubber or cork gasket. But a new design with a steel inner core designed to last and wear.  
1962-72 All - Small Block Ford® engines  
(Stock # B06-10915-025)

**OEM # C6OZ-6584-SC pair . . . . . 29.95**



## New Oil Pumps

NOTE: #'s ending in HV are high volume pumps, thus they push more product at a faster, higher volume than standard pumps.

1962-71 All - 352, 390, 427  
(Stock # P06-10965-095)

**OEM # COAZ-6600-HV each . . . . . 39.95**

1963-81 - 221, 260, 289, 302  
1969-72 - Boss 302  
(Stock # B06-10965-145)

**OEM # C2OZ-6600-HV each . . . . . 38.95**

1969-83 - 351W  
(Stock # B06-10965-220)

**OEM # C9OZ-6600-HV each . . . . . 52.95**



Motor Parts

# 1962-72 Fairlane

Motor Parts



**PCV Hose**  
 From valve to carburetor spacer  
 1965-67 Fairlane - 289  
 (Stock # P06-11100-006)  
**OEM # C6AZ-6A664-N each . . . . 13.95**  
 1968-72 Fairlane - 390  
 (Stock # P06-11100-007)  
**OEM # C8AZ-6A664-D each . . . . 19.95**  
 1969 Fairlane - 351W  
 (Stock # P06-11000-010)  
**OEM # C9AZ-6A664-A each . . . . 27.95**  
 1970 Fairlane - 351C  
 (Stock # P06-11100-037)  
**OEM # D0AZ-6A664-C each . . . . 21.95**



**PCV Valve**  
 1962-64 - 352, 390, 406  
 1963-68 - 427  
 (Stock # F06-11105-015)  
**OEM # C1TZ-6A666-A each . . . . 11.95**



**Chrome Oil Pan**  
 OEM Style - Perfect fit!  
 1962-72 - 221, 260, 289, 302  
 (Stock # B06-11115-020) **Price Reduced!**  
**OEM # C2OZ-6675-A each . . . . 89.95**

**Friend us on Facebook and follow us on Twitter. You never know what you might be in for.**

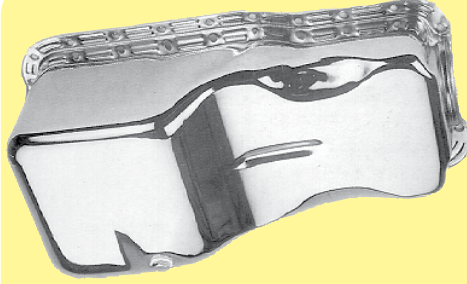

**Chrome Oil Pan**  
 OEM Style - Perfect fit!  
 1962-72 - 352, 390, 406, 427, 428 except CJ  
 (Stock # B06-11115-035) **Price Reduced!**  
**OEM # C7AZ-6675-A each . . . . 89.95**



**Chrome Oil Pan**  
 OEM Style - Perfect fit!  
 1962-72 - 351W  
 (Stock # B06-11115-050) **Price Reduced!**  
**OEM # C9OZ-6675-A each . . . . 64.95**



**Oil Pan Drain Plug**  
 1964-73 All  
 (Stock # P06-11175-020)  
**OEM # D1AZ-6730-A each . . . . 2.95**



**Oil Filter Element**  
 Spin-on, one piece filter with check valve.  
 Oil remains in top of engine for better lubrication during start up.  
 1962-72 All  
 (Stock # P06-11180-015)  
**OEM # C1AZ-6731-A each . . . . 7.95**



**Oil Filter Conversion Kit**  
 Converts older filters to the modern spin off filter.  
 (Stock # P06-11270)  
**OEM # B7A-6882-A kit . . . . . 26.95**



**Oil Pan Drain Plug Gasket**  
 Nylon - for longer life.  
 1962-72 All  
 (Stock # B06-11185-015)  
**OEM # C2OZ-6734-A each . . . . . 95**

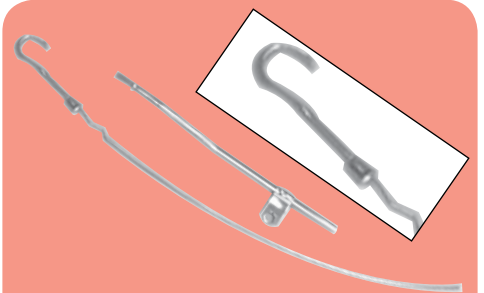

**Chrome Engine Oil Dipstick and Tube Set**  
 Aftermarket piece that is similar to the original and is chrome plated. NOTE: Due to different water pump designs, the bracket may need to be modified before installing.  
 1962-72 (289 302)  
 (Stock # B06-11200-050)  
**OEM # C2OZ-6750-A set . . . . . 9.95**



**Engine Oil Dipstick**  
 OEM style - Black  
 1962-64 - 221, 260, 289  
 (Stock # B06-11200-060)  
**OEM # C3OZ-6750-B each . . . . . 17.95**

# 1962-72 Fairlane

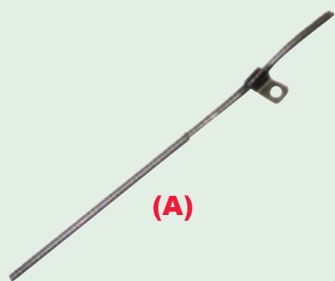

(A)

### Engine Oil Dipstick Tubes

- 1962-64 - 260, 289, and 289 Special 4V  
(Stock # B06-11210-010) - **black** (A)
- OEM # C2OZ-6754-A each** ..... 11.95  
(Stock # P06-11210-012) - **chrome**
- OEM # C2OZ-6754-AC each** .... 14.95
- 1965 - 289 and 289 Special  
(Stock # P06-11210-020) - **black**
- OEM # C5AZ-6754-A each** ..... 12.95  
(Stock # P06-11210-015) - **chrome**
- OEM # C5AZ-6754-AC each** ..... 15.95
- 1966-67 - 289  
(Stock # P06-11210-035) - **black**
- OEM # C6AZ-6754-A each** ..... 12.95  
(Stock # P06-11210-035) - **chrome**
- OEM # C6AZ-6754-AC each** ..... 15.95
- 1967-70 - Big Block  
(Stock # B06-11210-040) - **black**
- OEM # C7OZ-6754-A each** ..... 27.95
- 1969 - 351W  
(Stock # B06-11210-055) - **black**
- OEM # C9OZ-6754-A each** ..... 12.95  
(Stock # B06-11210-060) - **chrome**
- OEM # C9OZ-6754-C each** ..... 15.95



### Billet Dipstick

This functional dipstick uses an O-ring seal to eliminate leakage and blow-by. Designed to fit small block Chevy™ motors (up to '79) with driver's side dipstick.

**40120 each** ..... 36.95



(A)



(B)

### Oil Breather Caps

- 1962-68 Fairlane - Push-on style  
(Stock # P06-11225-035) - **black** (A)
- OEM # B6AZ-6766 each** ..... 5.95
- 1962-64 Fairlane - all
- 1965-67 Fairlane and Comet - 260-289  
(Stock # S06-11225-065) - **chrome** (B)
- OEM # C2SZ-6766-A each** ..... 5.95
- 1966-70 Fairlane - 144, 170, 200 and 250
- 1969-70 Comet and Montego - 250  
(Stock # F06-11225-070) - **black**
- OEM # C4TZ-6766-B each** ..... 5.95
- 1969-70 Comet and Montego - 250  
(Stock # P06-11225-075) - **chrome**
- OEM # C5ZZ-6766-D each** ..... 34.95
- 1968-71 Fairlane - 8 cylinder
- 1968 Comet - 427
- 1968-69 Comet and Montego - 390 and 428CJ
- 1969-70 Comet and Montego - 351W
- 1970 Comet and Montego - 429  
(Stock # P06-11225-080) - **twist on**
- OEM # C8AZ-6766-A each** ..... 37.95
- 1968-71 Fairlane and Torino - 6 cylinder  
(Stock # P06-11225-085) - **black**
- OEM # D1AZ-6766-A each** ..... 8.95



### Oil Filler Caps

- All machined from billet aluminum and available for a variety of applications. Weld-in style can be used by welding the bung to valve covers, aluminum tanks, etc. Weld-in bung is 6061-T6 aluminum and is 1 5/8" in diameter.
- Push-on 1 1/4" Valve Cover Hole
- 23120 each** ..... 43.95
- Twist on
- 23220 each** ..... 43.95
- Screw-on (Late GM)
- 23320 each** ..... 43.95
- Aluminum Weld-in Bung
- 24110 each** ..... 43.95

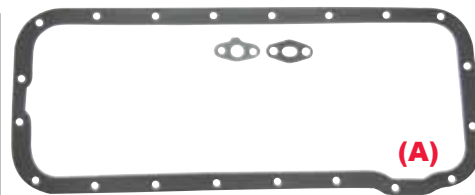

(A)

### Oil Pan Gasket Sets

- 1962-70 - 406, 427, 428  
(Stock # P06-11240-060) (A)
- OEM # C0AZ-6781-S set** ..... 21.95
- 1962-72 - 144, 170  
(Stock # X06-11240-070)
- OEM # C3DZ-6781-B set** ..... 19.95
- 1969-83 - 351W  
(Stock # P06-11240-080)
- OEM # D0AZ-6781-C set** ..... 24.95
- 1968-78 - 429, 460, except Boss & CJ  
(Stock # S06-11240-095)
- OEM # D0SZ-6781-A set** ..... 0.00



(A)

### PCV Valve Grommet

- D shaped hole
- 1966-72 Fairlane - 289, 302
- 1969 Fairlane - 351W  
(Stock # P06-11285-009) (A)
- OEM # C6AZ-6A892-A each** ..... 4.95
- D shaped hole with notches
- 1967-71 Fairlane - 289, 302  
(Stock # B06-11285-028)
- OEM # D0OZ-6A892-A each** ..... 3.95
- Round hole
- 1969-70 Fairlane G - 302 Special and 390  
(Stock # P06-11285-011)
- OEM # C7AZ-6A892-A each** ..... 4.95



### Air Cleaner Grommet

- 1 1/16" OD - 5/16" ID
- 1970 Fairlane - 8 cylinder except 351W  
(Stock # P06-11285-015)
- OEM # C8AZ-6A892-A each** ..... 2.95

Check out our website for information, and up to date pricing!

IF YOU HAVE ANY QUESTIONS, JUST GIVE US A RING!



# 1962-72 Fairlane

Transmission Parts



**New!**

## Transmission Dip Stick

1966-69 Fairlane - C6  
(Stock # B07-12050-100)  
**OEM # C6OZ-7A020-B each . . . . 15.95**  
1966-70 Fairlane - C4  
(Stock # P07-12050-200)  
**OEM # C6AZ-7A020-B each. . . . 19.95**



**Special ORDER**

## Pre-Bent Steel Transmission Lines

These are pre-bent to fit and flared on the ends with correct fittings included. Each set includes 2 lines - oil cooler inlet and outlet.

1963-64 Fairlane - 289 - C4  
(Stock # B07-12067-100)  
**OEM # C3OZ-7A030/1-A set . . . . 59.95**  
1964 Fairlane - 289-2V - Cruis-o-matic  
(Stock # B07-12067-105)  
**OEM # C4OZ-7A030/1-A set . . . . 41.95**  
1964 Fairlane - 289 - Cruise-O-Matic and C4 2V  
(Stock # B07-12067-110)  
**OEM # C4OZ-7A030/1-B set . . . . 49.95**  
1966 Fairlane - 8 cylinder - C-4  
(Stock # B07-12067-115)  
**OEM # C6OZ-7A030/1-A set . . . . 48.95**  
1966 Fairlane - 8 cylinder - C-6  
(Stock # B07-12067-120)  
**OEM # C6OZ-7A030/1-B set . . . . 65.95**  
1967 Torino C-4  
(Stock # B07-12067-125)  
**OEM # C7OZ-7A030/1-B set . . . . 49.95**  
1967-69 Fairlane - 8 cylinder - C-6  
(Stock # B07-12067-130)  
**OEM # C7OZ-7A030/1-A set . . . . 49.95**  
1967-70 Torino - 8 cylinder - C-4  
(Stock # B07-12067-135)  
**OEM # C7OZ-7A030/1-C set . . . . 49.95**

**We love when our customers bring their cars and trucks by. Feel free to drive yours up and show it off.**

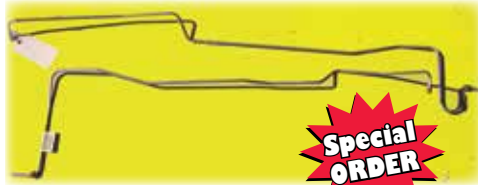

**Special ORDER**

## Pre-Bent Steel Transmission Lines

1969 Torino - FMX  
(Stock # B07-12067-140)  
**OEM # C9OZ-7A030/1-A set . . . . 59.95**  
1970 Torino - 8 cylinder - C-6  
(Stock # B07-12067-140)  
**OEM # D0OZ-7A030/1-A set. . . . 49.95**  
1971-73 Torino - 8 cylinder - C-6  
(Stock # B07-12067-150)  
**OEM # D1OZ-7A030/1-A set. . . . 75.95**



## Transmission Column Shift Selector Dial

1964-65 Fairlane  
(Stock # B07-12075-010)  
**OEM # C4OZ-7B033-B each. . . . 33.95**



## Transmission Column Shift Selector Dial

1967 Fairlane and Comet - C4 and C6 transmissions  
(Stock # B07-12565-420)  
**OEM # C7OZ-7A213-A each . . . . 34.95**



## Selector Dial Lens

This is the column gear shift selector dial lens for a fixed wheel.  
1968-69 Fairlane  
(Stock # S07-12085)  
**OEM # C8SZ-7B037-A each . . . . 24.95**



## Transmission Extension Housing Bushing

1 1/2" ID x 1 5/8" OD and 1 1/2" long  
1962-71 Fairlane and Torino - all  
(Stock # F07-12080-015)  
**OEM # B3TZ-7A034-A each. . . . 12.95**



## Transmission Extension Housing Oil Seal

1962-71 Fairlane and Comet - all 3 speed - except 65-66 - 200  
1969-71 Fairlane - 351, 390 - 4-speed  
(Stock # V07-12130)  
**OEM # 21C-7052-A each . . . . . 3.95**  
*Price Reduced!*  
1963-65 Fairlane - 8 cylinder - Warner 4-speed  
(Stock # P07-12130-025)  
**OEM # C2AZ-7052-A each. . . . . 3.95**  
*Price Reduced!*



## Automatic Transmission Control Selector Indicator

1968-72 Fairlane and Torino  
(Stock # P07-12315)  
**OEM # C8AZ-7A110-A each . . . . 19.95**



## Transmission Counter Shaft

1962-72 Fairlane - 4-speed manual trans  
(Stock # P07-12320-045)  
**OEM # C4AZ-7111-A each. . . . . 24.95**



# 1962-72 Fairlane



## Synchronizer Assembly

Low and reverse  
1965-71 Fairlane - 200, 250, 289, 292,  
351 - 3.03 - with tag TRG #HEF-HEG  
(Stock # P07-12360-015)  
**OEM # C6AZ-7124-B each . . . . . 89.95**



## Shift Lever Trunnion

4 speed floor shift.  
1965 Fairlane  
(Stock # P07-12365-005) **(A)**  
**OEM # C2AZ-7B125-A each . . . . . 5.95**  
1966-68 Fairlane - 4 speed  
1966-69 Fairlane - floor shift 3 speed  
(Stock # P07-12365-010) **(B)**  
**OEM # C2AZ-7B125-B each . . . . . 5.95**



## Floor Shift Lever Bushing

For automatic transmissions.  
1966-71 Fairlane and Torino  
1966-70 Comet and Montego  
(Stock # X07-12385-050)  
**OEM # C5ZZ-7A133-A each . . . . . 3.95**

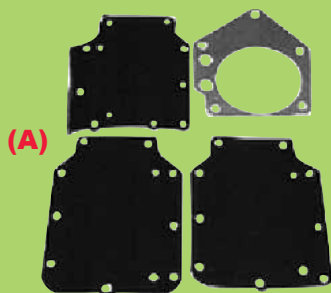

## Transmission Gasket Set

1962 Fairlane - 3 speed  
(Stock # P07-12425-040)  
**OEM # B8AZ-7153 set . . . . . 26.95**  
1963-72 Fairlane - 3 speed  
(Stock # P07-12425-060)  
**OEM # C3AZ-7153-F set . . . . . 21.95**  
1964-71 Fairlane - 4 speed except T10  
trans  
(Stock # P07-12425-065) **(A)**  
**OEM # C4AZ-7153-B set . . . . . 33.95**



## Automatic Transmission Kick-Down Cable

1966-68 Fairlane and Torino  
1969 Fairlane - C4 or Cruise-o-matic®  
1966-69 Comet and Montego **Price Reduced!**  
(Stock # B07-12495-010)  
**OEM # C6OZ-7A187-D kit . . . . . 3.95**

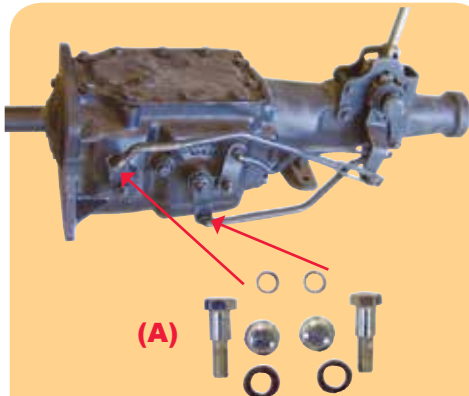

## Floor Shift Lever Kit

These rebuilding kits includes rubber insulators, springs and trunnions.  
1962-65 Fairlane - all 4 speed **(A)**  
(Stock # P07-12545-010) **Price Reduced!**  
**OEM # C2AZ-7208-A kit . . . . . 22.95**  
1965-68 Fairlane - all 3 speed floor shift  
1966-68 Fairlane - all 4 speed floor shift  
(Stock # P07-12545-005) **Price Reduced!**  
**OEM # C2AZ-7208-B kit . . . . . 27.95**



## Lower Shift Bracket

Both 3 and 4 speed lower shift bracket.  
1965-68 Fairlane - 4 speed  
1966-68 Fairlane - 3 speed floor shift  
(Stock # B07-12550-120)  
**OEM # C5ZZ-7210-D each . . . . . 49.95**



## Column Gear Shift Lever Knob

1962 Fairlane - early  
(Stock # X07-12565-210) - white w/recessed end  
**OEM # C0DZ-7213-W each . . . . . 9.95**  
1962 Fairlane - late  
(Stock # P07-12565-160) - black w/recessed end  
**OEM # C0AZ-7213-B each . . . . . 9.95**  
1963-65 Fairlane  
(Stock # P07-12565-130) - black without insert  
**OEM # B7A-7213-B each . . . . . 7.95**



## 4-Speed Shift Knob

Floor shift knob out of black plastic with bright metal base. Reverse is up and left.  
1962-65 Fairlane  
(Stock # P07-12565-215)  
**OEM # C2AZ-7213-A each . . . . . 17.95**



## 4-Speed Gear Shift Knob

Reverse is left and down. 1/2-20 thread size.  
1965-67 Fairlane  
(Stock # P07-12565-230)  
**OEM # C5ZZ-7213-A each . . . . . 14.95**



## 3-Speed Gear Shift Knob

1/2-20 thread size.  
1965-67 Fairlane  
1966-67 Comet  
(Stock # P07-12565-235)  
**OEM # C5ZZ-7213-H each . . . . . 18.95**



## Console "T" Handle Kit

Chrome plated. Complete with handle, knob, button and screw. For automatic transmission  
1966-72 Fairlane  
1966-68 Comet and Montego  
(Stock # P07-12565-240)  
**OEM # C5ZZ-7213-M each . . . . . 21.95**



## 4-Speed Shift Knob

1/2-20 thread size  
1967-68 Fairlane  
(Stock # P07-12565-245)  
**OEM # C7ZZ-7213-A each . . . . . 19.95**

# 1962-72 Fairlane

Transmission Parts



## Floor Shift Knob

Plastic insert with 4 speed pattern and racing stripe, with a wood grain base.

1968-69 Fairlane

(Stock # X07-12565-252)

**OEM # C80Z-7213-A each . . . . . 38.95**



## Floor Shift Knob

Original black knob with white shift pattern

1965-68 Fairlane

(Stock # B07-12565-250)

**OEM # C80Z-7213-B each . . . . . 18.95**



## Shift 'T' Handle

1968-69 Fairlane - automatic on the floor

**Black vinyl over chrome**

(Stock # B07-12565-256)

**OEM # C80Z-7213-BK each . . . . . 72.95**

**Dark blue vinyl over chrome**

(Stock # B07-12565-258)

**OEM # C80Z-7213-BL each . . . . . 78.95**

**Maroon vinyl over chrome**

(Stock # B07-12565-260)

**OEM # C80Z-7213-MR each . . . . . 84.95**

**Parchment vinyl over chrome**

(Stock # B07-12565-262)

**OEM # C80Z-7213-PA each . . . . . 85.95**

**Saddle vinyl over chrome**

(Stock # B07-12565-264)

**OEM # C80Z-7213-SA each . . . . . 73.95**

## Gear Shift Knob

Chrome plated automatic transmission column shift knob.

1966-72 Fairlane

1968-70 Comet and Montego

(Stock # B07-12565-270)

**OEM # D30Z-7213-A each . . . . . 17.95**



## Repair Buttons

Automatic transmission T-handle gear shift repair buttons.

1966-67 Fairlane

1966-68 Comet

**Left hand** - (Stock # P07-12950)

**OEM # C5ZZ-7C488-C each . . . . . 3.95**

**Right hand dummy** - (Stock # P07-12950-005)

**OEM # C5ZZ-7C488-D each . . . . . 2.95**

1968-71 Fairlane and Torino - before 11/8/71

**Left hand** - (Stock # B07-12950-015)

**OEM # C80Z-7C488-A each . . . . . 23.95**

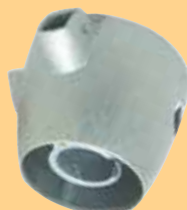

## Transmission Gear Shift Lever Socket

For top of steering column.

1962-67 Fairlane - 3 speed manual

1966-67 Comet - 3 speed man

(Stock # B07-12620-020)

**OEM # C20Z-7228-G each . . . . . 83.95**

1966-67 Fairlane and Comet - automatic

(Stock # P07-12620-025)

**OEM # C4AZ-7228-A each . . . . . 59.95**



## Transmission Dipstick Tube

1966-68 Fairlane - 289 C4 transmission

(Stock # B07-12620-199) - 19 1/4" long

**OEM # C60Z-7A228-B each . . . . . 19.95**



## Gearshift Insulator

1962-65 Fairlane

(Stock # M07-12680-005)

**OEM # 1M-7246-A each . . . . . 9.95**

1962-72 Fairlane - 3-speed

(Stock # B07-12680-020)

**OEM # C20Z-7246-A each . . . . . 4.95**



## Console Shift Selector Lever Linkage Cable

1972 Torino - 8 cylinder automatic transmission

(Stock # P07-12680-035)

**OEM # C5ZZ-7D246-A each . . . . . 12.95**



## Neutral Selector Switch

1965-66 Fairlane - C4 transmission column and console

(Stock # P07-12685-020)

**OEM # C4AZ-7A247-C each . . . . . 49.95**



## Shift Boot Retainer

Transmission gear shift lever boot retainer without console. Has a round base with four 3/8" bolt pattern. Chrome.

1962-64 Fairlane - 4 speed

(Stock # P07-12695) - **round** (A)

**OEM # C2AZ-7262-A each . . . . . 51.95**

1962-65 Fairlane - 4 speed

(Stock # P07-12695-005) - **square** (B)

**OEM # C3AZ-7262-A each . . . . . 107.95**

1969-72 Torino

(Stock # P07-12695-010) - **square**

**OEM # C9ZZ-7262-A each . . . . . 16.95**

**We accept these MAJOR credit cards.**



# 1962-72 Fairlane

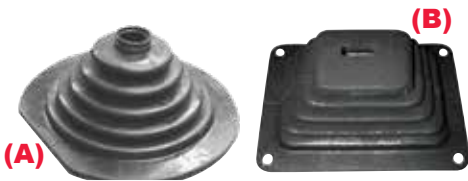

## Floor Shift Boot

Transmission gear shift lever boot with round base with cut-off. Has a 4 7/8" diameter bolt pattern. Used as a lower boot to cover the opening on gear shift lever plate.

1962-65 Fairlane - 4 speed without console  
(Stock # P07-12710-010) **(A) Price Reduced!**  
**OEM # C2AZ-7277-G each. . . . . 24.95**

1970-71 Torino - with Hurst 4 speed  
1970-71 Comet and Montego - 4 speed  
(Stock # P07-12710-020) **(B)**  
**OEM # D0ZZ-7277-B each. . . . . 26.95**

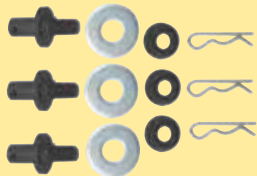

## Shifting Linkage Repair Kit

For all 4 speeds.

1962-72 Fairlane and Comet  
(Stock # P07-12725-005)  
**OEM # C5ZZ-7285-RPK2 kit. . . . . 17.95**



## Fiberglass Transmission Tunnel Cover

This is the hump that sits on the floor-board which the gear shift stick comes from.

1962-65 Fairlane  
(Stock # B07-12765-015) - 4 speed  
**OEM # C2OZ-7C309-FG each . . . 119.95**

1966-71 Comet and Cyclone  
(Stock # X07-12765-040) - 4 speed  
**OEM # C6DZ-7C309-FG each. . . . 99.95**

1966-71 Fairlane and Torino  
(Stock # B07-12765-045) - 4 speed  
**OEM # C6OZ-7C309-FG each . . . 89.95**

1970-71 Torino  
(Stock # B07-12765-055) - 4 speed  
**OEM # D0OZ-7C309-FG each . . . 41.95**



**Die Stamped Steel**

## 4-Speed Tunnel Hump

This is a quality die stamped steel reproduction of the original four speed tunnel hump used on 1963-1965 Fairlanes with factory four speed. This is just like the original with all factory shape and hole pattern included. Finally, a metal version made in the USA!

1963-65 Fairlane - 4 speed **Price Reduced!**  
(Stock # B07-12765-016)  
**OEM # C3OZ-7C309-A each . . . . . 0.00**



## Gear Shift Selector Arm Bushings and Insulator Kit

1962-67 Fairlane  
1966-67 Comet - 3 speed  
(Stock # F07-12835-010)  
**OEM # C3TZ-7343-A pair. . . . . 4.95**



## Automatic Transmission Shift Modulator Valves

1962-64 Fairlane - FM transmission  
1965-71 Fairlane - Cruis-o-matic® Trans - FM, MX or FMX  
(Stock # P07-12875)  
**OEM # C1AZ-7A377-A each . . . . 39.95**  
1965-71 Fairlane - C4 and C6 Trans  
(Stock # P07-12875-015)  
**OEM # C4AZ-7A377-B each. . . . . 35.95**

**1-800-654-3247**  
**Call Us for**  
**All-American**  
**Deals**



## Clutch Release Fork Dust Boot

1963-64 Fairlane - Ford® 3-speed or Warner 4-speed  
(Stock # P07-13005-015) **(A)**

**OEM # C3AZ-7513-A each. . . . . 13.95**  
1963-65 Fairlane - 6 cylinder, 2.77 design 3-speed

1963 Meteor - 170 **(B)**  
(Stock # B07-13005-020)  
**OEM # C3OZ-7513-A each. . . . . 14.95**



## Clutch Release Fork Dust Boot

1966-68 Fairlane, Torino and Comet - 200  
(Stock # M07-13005-035) **(A)**  
**OEM # C6GY-7513-A each. . . . . 12.95**

1966-69 Fairlane and Torino - 390, 427, 428  
1966-70 Comet and Montego - 390, 427, 428  
(Stock # B07-13005-040) **(B)**

**OEM # C6OZ-7513-A each. . . . . 11.95**



## Clutch Ford® Dust Boot

1965 Fairlane - except 2.77 trans  
1966-70 Fairlane/Torino - 250, 289, 302, 351  
1966 Comet - 200  
1966-71 Comet - 289, 302  
1969-71 Comet/Montego - 250, 351  
(Stock # B07-13005-045) **(A)**

**OEM # C6OZ-7513-C each. . . . . 12.95**  
1972 Fairlane - all **(B) Price Reduced!**

**OEM # C5AZ-7513-A each. . . . . 14.95**



## Clutch Fork

1965-68 Fairlane - 289, 302 - before 2-15-68  
(Stock # B07-13010-025) - 9 1/2" long **(A)**

**OEM # C5OZ-7515-B each. . . . . 59.95**  
1967-68 Fairlane - 6 cylinder  
(Stock # P07-13010-030) - 9" long **(B)**

**OEM # C7ZZ-7515-C each . . . . . 73.95**

Transmission Parts

# 1962-72 Fairlane

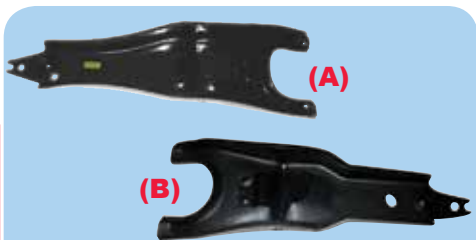

### Clutch Fork

1968 Fairlane - 289, 302  
(Stock # B07-13010-040) **(A)**  
**OEM # C80Z-7515-A each . . . . . 74.95**  
1968-69 Fairlane - 390  
(Stock # B07-13010-100) **(B)**  
**OEM # C80Z-7515-B each . . . . . 107.95**



### Clutch Fork

1968-69 Fairlane - 428CJ 4-speed  
1969 Fairlane - 250, 302, 351  
(Stock # B07-13010-045)  
**OEM # C80Z-7515-D each . . . . . 107.95**



### Clutch Pedal to Equalizer Rod

1966 Fairlane - 6 cylinder  
(Stock # B07-13025-030) **(A)**  
**OEM # C60Z-7521-E each . . . . . 49.95**  
1966-67 Fairlane - 289 **Price Reduced!**  
(Stock # P07-13025-033) - 6½" long  
**OEM # C6ZZ-7521-E each . . . . . 13.95**



### Clutch Pedal to Clutch Release Lever Rod

1967 Fairlane - 289 **(A)**  
(Stock # B07-13025-045) - 8½" long **Price Reduced!**  
**OEM # C70Z-7521-A each . . . . . 9.95**  
1969-71 Fairlane - 250, 302, 351 - adjustable  
(Stock # B07-13025-060)  
**OEM # C90Z-7521-A each . . . . . 16.95**



### Clutch Fork Pivot

Small block clutch fork pivot.  
1965-68 Fairlane  
(Stock # P07-13030-005)  
**OEM # B9AZ-7522-B each . . . . . 9.95**



### Clutch Release Lever Bracket

1962-68 Fairlane - 6 cylinder - before 2/15/68  
(Stock # X07-13030-010)  
**OEM # C2DZ-7522-B each . . . . . 19.95**  
1968-71 Fairlane - all V8 from 2/15/68  
(Stock # P07-13030-017)  
**OEM # C8AZ-7522-B each . . . . . 22.95**



### Clutch Pedal Bushing

Made of nylon  
1962-72 Fairlane and Torino  
1966-70 Comet and Montego  
(Stock # P07-13040-030) - ¾" ID  
**OEM # C0AZ-7526-B each . . . . . 1.95**



### Clutch Fork Rod Swivel

1967-69 Fairlane - except 390 and 428  
1970 Fairlane - except 429  
(Stock # X07-13050-145)  
**OEM # D1DZ-7A528-B each . . . . . 9.95**



### Clutch Equalizer Bar Seal

1970 Fairlane and Torino - 429 with 4 speed  
1971 Torino - all  
1970 Comet and Montego - 429 with 4 speed  
(Stock # P07-13055)  
**OEM # D0ZZ-7K530-A each . . . . . 0.00**



### Clutch Equalizer Bar Pivot

1962-65 Fairlane - engine side  
1969 Fairlane - 6 cylinder and 302/351W - engine side  
1970-71 Fairlane and Torino - 6 cylinder and all V8 - except 429 - engine side  
(Stock # P07-13060)  
**OEM # C20A-7A531-B each . . . . . 18.95**



### Clutch Pedal Rod Seal

1966-71 Fairlane and Torino  
1966-70 Comet and Montego  
(Stock # B07-13070-030)  
**OEM # C60Z-7A533-C each . . . . . 6.95**



### Clutch Pedal Spring

8½" long  
1962-65 Fairlane **(A)**  
(Stock # X07-13075-001)  
**OEM # C2AZ-7534-A each . . . . . 22.95**  
Installs at top of the clutch pedal arm.  
Complete with 2 nylon bushings.  
1968-71 Fairlane - 200/250 6 cylinder and 289/302 V8  
(Stock # B07-13075-010) **(B)**  
**OEM # C80Z-7534-B each . . . . . 39.95**



### Clutch Rod Adapter

Adapter is case hardened to OEM specifications and plated for years of service.  
1967-71 Fairlane - big block  
(Stock # B07-13080-200)  
**OEM # C80Z-7B535-A each . . . . . 23.95**



### Clutch Release Equalizer Shaft Ball

¾" OD x 7/16" ID x ½" thick  
1962-71 Fairlane - except 390, 428 and 429  
1966-70 Comet and Montego - 6 and 8 cylinder  
(Stock # X07-13100-010)  
**OEM # C1DD-7543-A each . . . . . 7.95**  
**1" OD**  
1969 Fairlane - 390 and 428  
1969-70 Comet and Montego  
1970 Fairlane and Torino - 428 and 429  
1971-72 Torino  
(Stock # P07-13100-005) **(A)**  
**OEM # C1AA-7543-A each . . . . . 2.95**



### Clutch Equalizer Bar Repair Kit

A must for all manual transmissions. Includes felt washers, nylon ball bushings, washers and clevis clips. Improves clutch operation. Fits 6 cylinder and small block V8  
1962-72 Fairlane - except 1965-71 390, 427, 428 and 429  
(Stock # X07-13100-014)  
**OEM # C1DD-7543-KT each . . . . . 15.95**

# 1962-72 Fairlane



## Clutch Pedal Pad Trim Ring

Stainless steel.

1965-71 Fairlane

(Stock # P07-13105)

**OEM # C5ZZ-7B544-A each . . . . . 9.95**

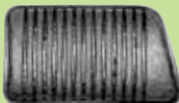

## Clutch Pedal Pad

1966-72 Fairlane and Torino

1966-70 Comet and Montego

(Stock # P07-13210)

**OEM # C5ZZ-7A624-B each . . . . . 4.95**



(A)

## Clutch Collar and Throwout Bearing Set

1962-71 Fairlane and Torino - 260, 289, 302

1963-70 Comet and Montego - 250, 260, 289, 351 and 390 - except GT

1966-69 Fairlane/Torino - 390 V8 except GT

1967-68 Comet/Montego - 200 except 10" clutch

(Stock # M07-13135-070) - 3 1/8" OD bearing

**OEM # MB-7561-S set . . . . . 33.95**

1960-64 Fairlane

(Stock # P07-13135-055) - 2 7/8" OD bearing

**OEM # B7A-7561 each . . . . . 44.95**

1962-64 Fairlane - 6 cylinder 4 speed

(Stock # B07-13135-065) - no bearing

**OEM # C30Z-7561-B each . . . . . 13.95**



## Clutch Release Lever Anti-Rattle Spring

1962-68 Fairlane

1966-68 Comet

(Stock # P07-13140-020)

**OEM # C6AZ-7562-A each . . . . . 4.95**



## Clutch Throwout Bearing

1962-64 Fairlane - 6 and 8 cylinder - 221, 223, 260, 289, 292, 352, 390 and 406 - manual and automatic transmissions (Stock # P07-13170-010)

**OEM # 8A-7580 each . . . . . 28.95**

1962-64 Fairlane - 6 cylinder - 4 speed

1965-66 Fairlane - 6 cylinder - 2.77 and all 4 speed

(Stock # X07-13170-030)

**OEM # C1DZ-7580-A each . . . . . 39.95**



## Clutch/Brake Pedal Arm Bumper

1962-65 Fairlane - manual brakes

(Stock # P07-13170-015)

**OEM # MA-7583-A each . . . . . 2.95**



(A)

## Clutch Pilot Bearings

1962-64 Fairlane - 6 cylinder - 3-speed and Dagenham 4-speed

(Stock # X07-13190-020)

**OEM # C0DD-7600-A each . . . . . 9.95**

1962-67 Fairlane - 260, 289

(Stock # B07-13190-025)

**OEM # C2OZ-7600-A each . . . . . 2.95**

1966-69 Fairlane - 390, 427, 428

(Stock # P07-13190-015)

**OEM # B8A-7600-A each . . . . . 6.95**

1968-73 Fairlane - 302, 351

1968-74 All - 200

(Stock # P07-13190-035)

**OEM # C8AZ-7600-A each . . . . . 9.95**



## Clutch Release Equalizer Shaft Bearing Retainer

"C" Clip

1965-70 Fairlane

(Stock # X07-13215)

**OEM # C1DD-7A629-A each . . . . . 2.95**



## Clutch Pedal Assist Spring Insulator

1966-67 Fairlane and Comet

(Stock # X07-13215)

**OEM # C1DZ-7A630-A each . . . . . 5.95**



## Idler Insulator

Insulator for the clutch fork rod.

1962-65 Fairlane

(Stock # P07-13220-050) - requires 2

**OEM # C3AZ-7A641-A each . . . . . 2.95**



## Overdrive Control Cable

Overdrive manual control cable assembly includes 80" cable, nut hardware, chrome plated handle, aluminum sleeve, crimping tool and cable shortening instructions.

1962-64 Fairlane

1962-63 Meteor

(Stock # P07-13225)

**OEM # A9AZ-7A650-A each . . . . . 59.95**



## Overdrive Cable Knob

Chrome plated with set screw

1962-67 Fairlane

(Stock # P07-13225-045)

**OEM # A9AZ-7A650-K each . . . . . 27.95**



## Torque Converter Housing Cover Plate

1965-70 Fairlane - 6 cylinder

(Stock # X07-13365-002)

**OEM # C5DZ-7986-A each . . . . . 21.95**

Price Reduced!



## Torque Converter Housing Cover Plate

1965-70 Fairlane - 8 cylinder - auto trans

(Stock # X07-13365-005)

**OEM # C5DZ-7986-B each . . . . . 11.95**

Transmission Parts

# 1962-72 Fairlane

Radiator Parts

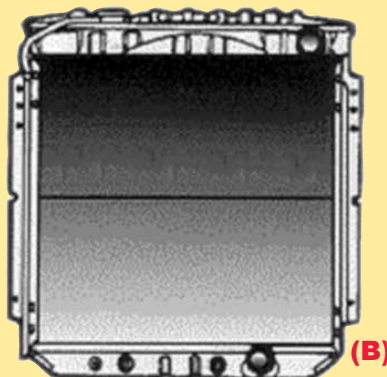

## New USA Made Copper/Brass Radiators

All our radiators are made to order and take approximately. 2-3 weeks for delivery.

1962-69 Fairlane - 260, 289, 302, 351	
1966-69 Comet - 260, 289, 302, 351	Price Reduced!
(Stock # P08-14010-175) - 3 row core - 17 <sup>3</sup> / <sub>8</sub> " x 20 1/4" x 1 1/4"	
<b>OEM # C4AE-8005-S each</b> .....	<b>525.00</b>
1962-69 Fairlane - 200	
966-68 Comet - 200	
(Stock # B08-14010-230) - 2 row core - 17 <sup>3</sup> / <sub>8</sub> " x 20 <sup>1</sup> / <sub>4</sub> " x 1 <sup>1</sup> / <sub>4</sub> "	
<b>OEM # C7OZ-8005-A each</b> .....	<b>364.95</b>
1962-69 Fairlane - 250	
1967-69 Comet - 250	
(Stock # X08-14010-257) - 2 row core - 17 <sup>3</sup> / <sub>8</sub> " x 20 <sup>1</sup> / <sub>2</sub> " x 1 <sup>1</sup> / <sub>4</sub> "	
<b>OEM # C9OZ-8005-B each</b> .....	<b>339.95</b>
1963-69 Fairlane - 6 cylinder	
(Stock # B08-14010-185) - 2 row core	Price Reduced! (A)
<b>OEM # C4OE-8005-B each</b> .....	<b>464.95</b>
1966 Fairlane - 289	
(Stock # B08-14010-210) - 3 row core	
<b>OEM # C6OZ-8005-A each</b> .....	<b>444.95</b>
1966 Comet - 390	
(Stock # B08-14010-400) - 3 row core - 17 <sup>3</sup> / <sub>8</sub> " x 23 <sup>1</sup> / <sub>4</sub> "	
<b>OEM # C6OE-8005-A each</b> .....	<b>599.95</b>
1967 Fairlane - 390	
1967 Comet - 390, 427	
(Stock # M08-14010-221) - 3 row core - 17 <sup>3</sup> / <sub>8</sub> " x 23 <sup>1</sup> / <sub>4</sub> " x 2"	Price Reduced!
<b>OEM # C7MY-8005-A each</b> .....	<b>469.95</b>
1967 Fairlane - 289	
1968 Fairlane - 289, 302	(B)
(Stock # B08-14010-225) - 2 row core	
<b>OEM # C7OE-8005-J each</b> .....	<b>236.95</b>
1968-69 Fairlane, Torino and Comet - 390, 428	
(Stock # M08-14010-233) - 3 row core - 17 <sup>3</sup> / <sub>8</sub> " x 24 <sup>1</sup> / <sub>4</sub> " x 2"	Price Reduced!
<b>OEM # C8MY-8005-A each</b> .....	<b>386.95</b>
1968-69 Fairlane and Torino - 289, 302, 351	
1968-69 Comet - 302, 351	
(Stock # B08-14010-240) - 3 row core - 17 <sup>3</sup> / <sub>8</sub> " x 24 <sup>1</sup> / <sub>4</sub> " x 2"	
<b>OEM # C8OZ-8005-A each</b> .....	<b>500.00</b>

- USA MADE
- Correct Fit
- Performance Cooling
- 2, 3 & 4 Row Cores

1970 Torino - 250 all, 302 all & 351 without AC	
(Stock # P08-14010-255) - 2 row core	Price Reduced!
<b>OEM # C9AE-8005-K each</b> .....	<b>215.95</b>
1970-71 Torino - 6 cyl & Small Block with air	
(Stock # B08-14010-265) - 3 row core	Price Reduced!
<b>OEM # D0OZ-8005-A each</b> .....	<b>349.95</b>
1970 Torino - 429 without AC	(C) Price Reduced!
(Stock # P08-14010-250) - 2 row core	
<b>OEM # C9AE-8005-E each</b> .....	<b>295.95</b>
1970 Torino - 351 all and 429 with AC	
(Stock # B08-14010-264) - 3 row core	Price Reduced!
<b>OEM # D0OE-8005-A each</b> .....	<b>552.95</b>
1970-71 Torino - Big Block	
(Stock # B08-14010-266) - 4 row core	Price Reduced!
<b>OEM # D0OZ-8005-B each</b> .....	<b>509.95</b>
1972-75 Torino - 250	
1972-76 Torino - V8	
(Stock # B08-14010-550) - 3 row core - 17 <sup>3</sup> / <sub>4</sub> " x 28"	
<b>OEM # D2OZ-8005-A each</b> .....	<b>525.00</b>
1972-76 Torino - V8	
(Stock # B08-14010-555) - 4 Row Core - 17 <sup>3</sup> / <sub>4</sub> " x 28"	
<b>OEM # D2OZ-8005-B each</b> .....	<b>619.95</b>

## • 1 Yr. Limited Warranty

*Since we cannot confirm the application or the installation, it is your responsibility that the radiator be properly installed. We highly recommend having a professional do the installation as warranty will not apply as the result of incorrect or damaged installation.*

**OVERSIZED FREIGHT CHARGES WILL APPLY ON RADIATORS.**

- 1/2" tubes
- 9/16" centers
- Drop in Stock Replacements
- Highest Quality

# 1962-72 Fairlane



### Radiator Coolant Filters

Aluminum machined, professional. Complete with clamps as shown.

1962-72 Fairlane and Comet - 6 cylinder (Stock # P08-14015)

OEM # COAZ-8006-A6 set ..... **0.00**

1962-72 Fairlane and Comet - 8 cylinder (Stock # P08-14015-005)

OEM # COAZ-8006-A8 set ..... **84.95**

Price Reduced! (A)

(B)



### Radiator Drain Cock

1/4" pipe thread

1962-64 Fairlane

(Stock # P08-14090-005)

OEM # 8A-8115 each..... **5.95**



C3AZ-8124-A

C7OZ-8124-A

### Radiator to Frame Pad

1966 Fairlane - 390 - upper pads

(Stock # P08-14105-010)

OEM # C3AZ-8124-A each..... **11.95**

1967 Fairlane - 390 and 427

1968-70 Fairlane - 390, 427 and 428CJ

1967-69 Comet - upper pad - takes 2

(Stock # B08-14105-015)

OEM # C7OZ-8124-A each..... **13.95**



### S.M.C.O. Radiator Caps

1962-66 Fairlane and Comet - 12-15 lb.

(Stock # P08-14060-100) - zinc (A)

OEM # B8A-8100-A each..... **26.95**

1962-66 Fairlane and Comet - 12-15 lb.

(Stock # S08-14060-110) - chrome

OEM # C2SZ-8100-A each..... **19.95**

Autolite 13 lb. Replacement

1965-72 Fairlane and Comet (B)

(Stock # P08-14060-120) - chrome

OEM # C9ZZ-8100-A each..... **25.50**



### Replacement Style Radiator Cap

1963-71 All - 7 lbs.

(Stock # P08-14060-080)

OEM # B2AZ-8100-A each..... **12.95**

Price Reduced!



### Replacement Style Radiator Cap

1963-71 Fairlane and Comet - 7 lbs. - 3/4" neck depth

(Stock # P08-14060-085)

OEM # B2AZ-8100-F each..... **3.95**

1963-72 Fairlane and Comet - 12-15 lbs.

(Stock # F08-14060-105)

OEM # C1UZ-8100-A each..... **5.95**

(A)

(B)

### Lower Radiator Mounting Pad

1966 Fairlane - 390

1967 Fairlane - 390 and 427

(Stock # P08-14110-035)

OEM # C3AZ-8125-A each..... **9.95**

1969-70 Fairlane - 351, 390, 427 and

428CJ with air

(Stock # B08-14110-067)

OEM # C8ZZ-8125-A each..... **6.95**

1971 Fairlane - 6 and 8 cylinder

(Stock # S08-14110-060)

OEM # C7SZ-8125-C each..... **7.95**

top

(A)

bottom

**We accept these MAJOR credit cards.**

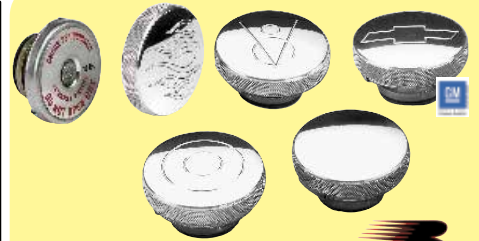

### Billet Radiator Caps

These radiator caps have a machined billet top (see flamed for example) with knurled grip sides in your choice of 7 lb. or 16 lb. caps. Billet tops are packaged unassembled with the radiator cap to allow proper positioning of the logo when you put it on your vehicle.

Plain

16 lb. - 75120 each ..... **29.95**

7 lb. - 76120 each ..... **29.95**

Circle

16 lb. 75220 each ..... **29.95**

Bowtie

16 lb. - 75320 each ..... **29.95**

7 lb. - 76320 each ..... **29.95**

V-8

16 lb. - 75420 each ..... **29.95**

7 lb. - 76420 each ..... **29.95**

Flame

16 lb. - 75820 each ..... **0.00**

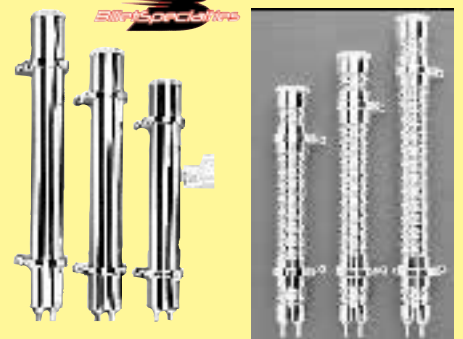

### Billet Overflow Tanks

Constructed from billet aluminum these overflow tanks include adjustable mounting hardware that allows placement along the entire length of the tank. All tanks have a knurled and threaded cap with O-ring seal for easy removal. Lengths specified are of the tank, overall measurement is 1-1/2" longer than listed. Diameter is 2 inches.

Smooth Overflow

13" - 10 oz. - 77113 each ..... **145.95**

15" - 13 oz. - 77115 each ..... **145.95**

17" - 16 oz. - 77117 each ..... **145.95**

Ribbed Overflow

13" - 10 oz. - 77213 ..... **158.95**

15" - 13 oz. - 77215 ..... **158.95**

17" - 16 oz. - 77217 ..... **158.95**

# 1962-72 Fairlane

Radiator Parts



### Fan Shroud

The height is 19¼ inches, width 20 inches. The distance between the bottom bolts is 19¾, distance between the top bolts is 19¾, distance between the top bolt and bottom bolt is 15¼ and the hole, which is the diameter of the opening of the shroud is 19".

1966-69 Fairlane, Rancho and Torino with 289 and 302 engines with air.

1969 Torinos - 351-2V - with 20" radiator. Also 302, 351 with add on air conditioning. 20 - 1/4" Center

(Stock # B08-14140-075) - ABS Plastic

**OEM # C9OZ-8146-B each . . . . 119.95**



### Fan Shroud

Fits 1968 390, 427, and 428 CJ, and 1968 390 GT and 428. The height is 20¾ inches, width 25½ inches. The distance between the bottom bolts is 24½, distance between the top bolts is 24½, distance between the top bolt and bottom bolt is 10 and the hole, which is the diameter of the opening of the shroud is 20. All measurements are approximate!

1968-69 Fairlane, Torino, Montego and Rancho - 390, 427, 428

(Stock # B08-14140-050) - ABS Plastic **Price Reduced!**

**OEM # C8OZ-8146-F each . . . . 139.95**



### Fan Shroud

The height is 20½ inches, width 22¾ inches. The distance between the bottom bolts is 13, distance between the top bolts is 17½ and the hole, which is the diameter of the opening of the shroud is 19. All measurements are approximate!

1970-71 Fairlane, Torino, Montego and Rancho - 302, 351 without air

(Stock # B08-14140-080) - ABS Plastic **Price Reduced!**

**OEM # D0OZ-8146-C each . . . . 129.95**



### Fan Shroud

The height is 19¾ inches, width 24¼ inches. The distance between the bottom bolts is 24, distance between the top bolts is 24, distance between the top bolt and bottom bolt is 10 and the hole, which is the diameter of the opening of the shroud is 19¾. All measurements are approximate!

1966-67 Fairlane, Torino and Comet - 390, 427

1967 Rancho and Cyclone GT - 390, 427

(Stock # B08-14140-025) - ABS Plastic **Price Reduced!**

**OEM # C6OZ-8146-F each . . . . 119.95**

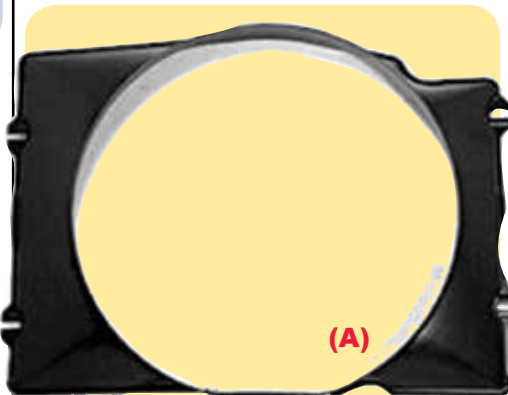

### Fan Shroud

1969 Fairlane and Torino - 351 with 24" radiator

(Stock # B08-14140-070) - ABS Plastic **(A)**

**OEM # C9OZ-8146-A each . . . . 86.95**

**Online order is available 24/7!**

**www.ClassicAutoParts.com**



### Fan Shroud

The height is 22 inches, width 26¼ inches. The distance between the bottom bolts is 13½, distance between the top bolts is 18, distance between the top bolt and bottom bolt is 18 and the hole, which is the diameter of the opening of the shroud is 20. All measurements are approximate!

1970-71 Torino - 302, 351 with AC **Price Reduced!**

(Stock # P08-14140-130) - ABS Plastic **OEM # D3ZZ-8146-A each . . . . 119.95**

1970-71 Torino - 302 and 351 - without AC (Stock # B08-14140-083)

**OEM # D0OZ-8146-B each . . . . 179.95**

# 1962-72 Fairlane



### Fan Shroud

The height is 21¼ inches, width 27¾ inches. The distance between the top bolts is 18" and the hole, which is the diameter of the opening of the shroud is 20¼. All measurements are approximate!

1970-71 Fairlane, Torino, Montego and Ranchero - 429  
(Stock # B08-14140-085) - ABS Plastic **Price Reduced!**  
**OEM # D00Z-8146-D each . . . . 179.95**



### Fan Shroud

The height is 21 inches, width 29 inches. The distance between the bottom bolts is 14, distance between the top bolts is 19, distance between the top bolt and bottom bolt is 17½ and the hole, which is the diameter of the opening of the shroud is 19½. All measurements are approximate!

1972-76 Fairlane/Torino/Montego  
1972-79 Ranchero - 302, 351, 400  
(Stock # B08-14140-100) - ABS Plastic **Price Reduced!**  
**OEM # D20Z-8146-A each . . . . 119.95**



### Fan Shroud

The height is 21¼ inches, width 28¼ inches. The distance between the bottom bolts is 13¾, distance between the top bolts is 19½, distance between the top bolt and bottom bolt is 19¾ and the hole, which is the diameter of the opening of the shroud is 20¼. All measurements are approximate!

1972-73 Torino/Ranchero - 429  
(Stock # S08-14140-105) - ABS Plastic **Price Reduced!**  
**OEM # D2SZ-8146-A each . . . . 119.95**

**If you think you can do a thing or think you can't do a thing, you're right.**  
~Henry Ford

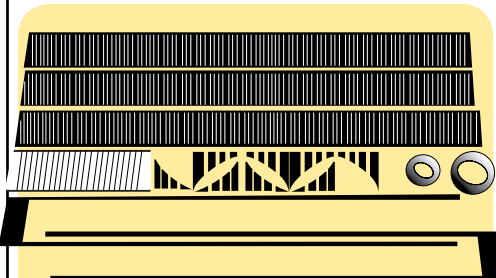

### Grill Vinyl Trim Kit

Vinyl trim that is used to replace your factory paint accents on your original aluminum grill and rear panel molding. Precision cut black vinyl made to match your factory paint accents.

1963 Fairlane **New!**  
(Stock # B08-14230-353)  
**OEM # C30Z-8200-VTK kit . . . . 179.95**

**Friend us on Facebook and follow us on Twitter. You never know what you might be in for.**



### Standard Grill Emblem

These are beautifully detailed reproductions of the original Ford® emblems. They are injection molded plastic as original.

1966 Fairlane - standard  
1967 Fairlane and Ranchero  
(Stock # B08-14270-035)  
**OEM # C60Z-8213-E each . . . . . 59.95**



(A)



(B)

### Grill Emblem Insert

These are a beautiful, detailed reproduction of the original. They are injection molded plastic as original.

1966 Fairlane - GT (A)  
(Stock # B08-14270-040)  
**OEM # C60Z-8213-GTI each . . . . 49.95**  
1966 Fairlane - XL (B)  
(Stock # B08-14270-045)  
**OEM # C60Z-8213-XLI each . . . . 49.95**



(A)



(B)

### Grill Emblem Insert

These are a beautiful, detailed reproduction of the original. They are injection molded plastic as original.

1967 Fairlane - GT (A)  
(Stock # B08-14270-050)  
**OEM # C70Z-8213-GTI each . . . . 49.95**  
1967 Fairlane - XL (B)  
(Stock # B08-14270-060)  
**OEM # C70Z-8213-XLI each . . . . 49.95**



### GT Grill Letters

Triple chrome plated with original red paint scheme. Complete with mounting hardware.

1969 Torino and Ranchero - GT  
(Stock # B08-14270-070)  
**OEM # C90Z-8213-AB each . . . 161.95**

# 1962-72 Fairlane



### Grill Center Adhesive Decal

1970 Torino - GT (A)  
 (Stock # B08-14270-077)  
**OEM # D00Z-8213-ADEC each . . 23.95**  
 1970 Torino - except GT (B)  
 (Stock # B08-14270-078)  
**OEM # D00Z-8213-BDEC each . . 23.95**



### Grill Emblem

Pressure die cast and includes center aluminum embossment and correct factory paint.  
 1970 Torino and Ranchero - GT (A)  
 (Stock # B08-14270-075) **Price Reduced!**  
**OEM # D00Z-8213-A each . . . . 119.95**  
 1970 Torino and Ranchero - except GT (B)  
 (Stock # B08-14270-076) **Price Reduced!**  
**OEM # D00Z-8213-B each . . . . 129.95**



### Radiator Hose Set

Features FOMOCO® script and part number. Set includes upper, lower and bypass hoses.  
 1964-67 Fairlane - 260-289  
 (Stock # X08-14385-145)  
**OEM # C3DZ-8260-K set . . . . . 41.95**

**We have tried to make ordering easy. You can order online with a click of the mouse, or use the order sheets in the back of the catalog. Simply mail or fax over. We'll handle it all from there.**



### Radiator/Heater Hose Clamp Kits

These are the original style hose clamps. Each kit has the necessary amount for each application. Includes 10 clamps.  
 1964-68 Fairlane - 170 and 200  
 1964-68 Comet - 6 cylinder  
 (Stock # P08-14460-050)  
**OEM # COAZ-8287-6K kit. . . . . 19.95**  
 1964-68 Fairlane - 260, 289, 302 and 351  
 1964-68 Comet - 8 cylinder  
 (Stock # P08-14460-090)  
**OEM # COAZ-8287-S8K kit. . . . . 43.95**  
 1964-68 Fairlane and Comet - 390, 427, 428  
 (Stock # P08-14460-055)  
**OEM # COAZ-8287-B8K kit . . . . . 33.95**



### Radiator Grill Molding Clip

1970 Torino  
 (Stock # B08-14370-005)  
**OEM # D00B-8B251-A each . . . . 0.95**



### Radiator Support Seals

Does top of radiator  
 1972 Torino and Ranchero  
 (Stock # B08-14530-055) **Price Reduced!**  
**OEM # D2OZ-8327-A each . . . . . 26.95**



### Radiator Grill Opening Rubber Seal

1969 Fairlane  
 (Stock # B08-14570-015) - **Cut to fit**  
**OEM # C9OZ-8B391-A each . . . . 18.95**



### Water Pumps

1962-66 Fairlane - 221, 260, and 289  
 1966 Comet - 290  
 (Stock # B08-14620-135) - **Aluminum housing**  
**OEM # C2OZ-8501-A each. . . . . 86.95**  
 1965-68 Fairlane - 170 and 200  
 1965-68 Montego - 200 (A)  
 (Stock # X08-14620-125)  
**OEM # CODZ-8501-A each. . . . . 69.95**  
 1965-69 Fairlane - 289, 302 and 351  
 1966-68 Comet and Montego - 289 and 302  
 1969 Comet and Montego - 302 and 351  
 (Stock # P08-14620-150) - **Cast Iron Housing**  
**OEM # C5AZ-8501-H each Price Reduced! 52.95**  
 1969-71 Comet and Montego - 250  
 (Stock # X08-14620-190)  
**OEM # D2DZ-8501-A each . . . . . 45.95**  
 1970 Comet and Montego - 429 and 429CJ  
 1971 Comet and Montego - 429  
 (Stock # M08-14620-185)  
**OEM # D1VY-8501-B each. . . . . 61.95**



### Water By-Pass Tube

1962-70 Fairlane - straight - 5/8" OD x 2 1/2" long  
 (Stock # P08-14745-005) (A)  
**OEM # C5AZ-8555-B each. . . . . 3.95**  
 1968-69 Fairlane - 302 and 351W  
 (Stock # B08-14745-015)  
**OEM # C8OZ-8555-A each. . . . . 3.95**



### Thermostat

1962-70 Fairlane - 170, 200, 221, 260, 289  
 1962-63 Meteor - 221, 260 and 289  
 1968-72 Fairlane - 429 (A)  
 (Stock # P08-14765-025) - **160 degrees**  
**OEM # 8BA-8575 each . . . . . 6.95**  
 1962-66 Fairlane - 352, 390, 406, 427, 428  
 1962-64 Fairlane - all 6 cylinder except 144, 170, 200  
 (Stock # F08-14765-040) - **160 degrees** (B)  
**OEM # B4C-8575-A each. . . . . 6.95**

**Call Us:**  
**1-800-654-3247**

# 1962-72 Fairlane



## Water Outlet

Also called a thermostat housing.

1962 Fairlane - 170

1965-68 Fairlane - 200

(Stock # X08-14785-050)

**OEM # C1DZ-8592-C each . . . . . 11.95**

1965-72 All - 240

(Stock # P08-14785-065)

**OEM # C5AZ-8592-A each . . . . . 9.95**

1965-67 Fairlane - 390

1968-69 Fairlane - 390, 427, 428CJ

(Stock # P08-14785-070)

**OEM # C5AZ-8592-B each . . . . . 33.95**

1965-75 - 260, 289, 302, 351W

(Stock # B08-14785-090) - die cast aluminum

**OEM # C9OZ-8592-A each . . . . . 27.95**

1965-75 - 260, 289, 302, 351W

(Stock # B08-14785-095) - chrome plated

**OEM # C9OZ-8592-CH each . . . . . 9.95**

Price Reduced!



## Water By-Pass Hose

1962-64 Fairlane - 221, 260, 289, 302, 351

1963-69 Comet - 221, 260, 289 and 302  
(Stock # B08-14795)

**OEM # C2OZ-8597-B each . . . . . 5.95**

1962-67 Fairlane - 352, 390, 427, 428

1968 Fairlane - 170, 200

(Stock # B08-14795-005)

**OEM # C2OZ-8597-D each . . . . . 11.95**

1965-69 Fairlane - 260, 289 and 302

(Stock # F08-14795-020)

**OEM # D2PZ-8597-A each . . . . . 9.95**

1969-72 Fairlane and Torino - 351W

1970-72 Fairlane and Torino - 302

1970 Comet - 302

(Stock # B08-14795-015)

**OEM # D0OZ-8597-B each . . . . . 16.95**



## Hirsch Gas Tank Sealer

Alcohol resistant gas tank sloshing compound. Impervious to all fuel types. This will help you restore and repair your tank. It will seal pinhole leaks and prevent rusting. Sold per quart

(Stock # A09-15005-005)

**OEM # A-9001-ALR each . . . . . 38.95**

## Hirsch Gas Tank Etch

This is a prep for your gas tank before introducing the sealer. It will remove light buildup of rust inside your tank and leaves a grey phosphate coating. 1 pint will do about a 30 gallon tank.

(Stock # A09-15005-010)

**OEM # A-9001-GTE each . . . . . 15.95**



## Swivel Thermostat Housing

All thermostat housing are machined from billet aluminum and feature a positive O-ring seal which eliminates the need for gaskets or sealant.

Ford® Small Block

**90620 0 Degree . . . . . 166.95**

Ford® Big Block

**90720 0-Degree . . . . . 166.95**

**90725 15-Degree . . . . . 166.95**

Ford® FE

**90730 . . . . . 166.95**

**Save on shipping by watching for our Free Freight e-mails. You can join our e-mail club at [www.ClassicAutoParts.com](http://www.ClassicAutoParts.com)**

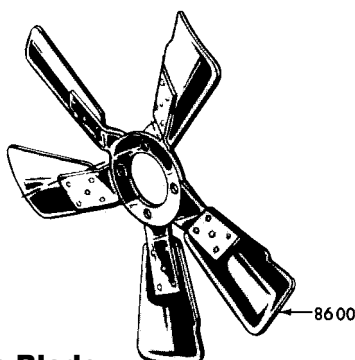

## Fan Blade

This is a five blade fan.

1965-67 Fairlane - 200, 289

1970 Fairlane - 250

(Stock # P08-14800-060)

**OEM # C5AZ-8600-A each . . . . . 74.95**



## Fan Clutch

Non-thermal

1965-70 Fairlane - 429

(Stock # S08-14830-025)

**OEM # C4SZ-8A616-K each . . . . . 83.95**

1972 Fairlane/Torino - 429

(Stock # S08-14830-050)

**OEM # C8SZ-8A616-B each . . . . . 72.95**



## KBS Fuel Tank Sealer Kit

The KBS Fuel Tank Sealer Kit contains everything you need to seal a tank of up to 25 gallons. Contains 2 qts. AquaClean, 1 qt. RustBlast, 1 qt. Gold Standard tank sealer, 1 pair Nitrile gloves and a stir stick. These KBS prep products are formulated with a unique Oxygen-Block Technology which reduces the occurrence of flash rust by over 80% and extends rust-free storage times by leaving a temporary protective coating in addition to a zinc phosphate film.

**KBS-9000 kit . . . . . 79.95**

**Check out our website for information, and to check up to date pricing!**

# 1962-72 Fairlane

Gas Tank & Fuel Related Parts



### New Gas Tank - Steel

1962-65 Fairlane  
1962-63 Meteor  
(Stock # B09-15010-187) - 16 gallon  
**OEM # C2OZ-9002-A each. . . . 399.95**



### New Steel Gas Tank

**36<sup>3</sup>/<sub>4</sub>" x 29<sup>3</sup>/<sub>4</sub>" x 6<sup>3</sup>/<sub>4</sub>"**  
1971 Cyclone, Montego and Torino - except Station Wagon  
(Stock # B09-15010-252)  
**OEM # D1OZ-9002-A each . . . . 557.95**  
**35<sup>1</sup>/<sub>2</sub>" x 28<sup>1</sup>/<sub>2</sub>" x 10"**  
1972-73 Torino - except Ranchero and Station Wagon  
1972-73 Montego - except Station Wagon  
(Stock # B09-15010-255)  
**OEM # D2OZ-9002-A each . . . . 438.95**



### New Steel Gas Tank

**30<sup>1</sup>/<sub>2</sub>" x 37<sup>3</sup>/<sub>4</sub>" x 8<sup>1</sup>/<sub>2</sub>"**  
1966-69 Fairlane and 1968-69 Torino - 2 door and 4 door Sedan, Hardtop - except Station Wagon  
(Stock # B09-15010-234) - 20 gallon  
**OEM # C6OZ-9002-A each. . . . 359.95**  
**30<sup>1</sup>/<sub>2</sub>" x 37<sup>3</sup>/<sub>4</sub>" x 8<sup>1</sup>/<sub>2</sub>"**  
1967-69 Fairlane and Torino Fastback  
(Stock # B09-15010-242) - 20 gallon  
**OEM # C6OZ-9002-B each. . . . 369.95**  
**30<sup>1</sup>/<sub>2</sub>" x 37<sup>3</sup>/<sub>4</sub>" x 8<sup>1</sup>/<sub>2</sub>"**  
1966-1969 Comet - except Station Wagon and Convertible  
1966-1969 Cyclone 2 door Fastback and Hardtop - except Station Wagon and Convertibles  
1968-69 Montego - except Station Wagon and Convertible  
(Stock # B09-15010-243) - 20 gallon  
**OEM # C6OZ-9002-C each. . . . 349.95**  
**36<sup>3</sup>/<sub>4</sub>" x 29<sup>3</sup>/<sub>4</sub>" x 6<sup>3</sup>/<sub>4</sub>"**  
1970 Fairlane, Torino, Cyclone and Montego - except Station Wagon - with EEC  
(Stock # B09-15010-249)  
**OEM # D0OZ-9002-A each . . . . 489.95**



### Gas Tank Door Bumpers

1962-63 Fairlane  
(Stock # B09-15010-190)  
**OEM # C2OZ-9002-BM pair. . . . . 4.95**  
1964-65 Fairlane  
(Stock # B09-15010-215)  
**OEM # C4OZ-9002-BM pair. . . . . 4.95**  
1966-68 Fairlane  
(Stock # B09-15010-240)  
**OEM # C6OZ-9002-BM pair. . . . . 2.95**



### Fuel Gauge Tank Unit Filter

1965-72 Fairlane  
1966-71 Comet, Cyclone and Montego  
**For 3/8" outlet**  
(Stock # P09-15040)  
**OEM # D1AZ-9A011-A each . . . . . 5.95**  
**For 1/2" outlet**  
(Stock # F09-15040-005)  
**OEM # D1FZ-9A011-A each. . . . . 5.95**

**Please allow 7-14 days  
for Special Orders!**



### Gas Cap

Vented - Anti Surge  
1963-64 Fairlane Station Wagon - only  
(Stock # X09-15060-095)  
**OEM # C0DZ-9030-D each. . . . . 11.95**



### Locking Gas Cap

1963-65 Fairlane Station Wagon  
1967-69 Ranchero  
(Stock # P09-15060-120)  
**OEM # C4RZ-9030-A each. . . . . 15.95**



### Locking Gas Cap

Vented - 2<sup>1</sup>/<sub>4</sub>" OD  
1962-64 Fairlane - except Station Wagon  
(Stock # P09-15060-125)  
**OEM # C4RZ-9030-B each. . . . . 13.95**



### Gas Cap

Vented - non locking  
1962-65 Fairlane  
1966-70 Fairlane Station Wagon  
(Stock # P09-15060-135)  
**OEM # C5AZ-9030-A each. . . . . 8.95**



### Locking Gas Cap

Vented - 2<sup>1</sup>/<sub>4</sub>" OD  
1968-69 Fairlane - except Station Wagon  
(Stock # P09-15060-130)  
**OEM # C4RZ-9030-C each. . . . . 16.95**



**Obsolete &  
ClassicAutoParts, Inc.**

# 1962-72 Fairlane



## Gas Cap

Vented - Non-locking  
1966-69 Comet - except Station Wagon  
1968-69 Cyclone/Montego  
(Stock # P09-15060-160)  
**OEM # C7AZ-9030-A each . . . . . 6.95**



## Gas Cap

Non Vented - Non-locking  
1970 and 1972 Fairlane/Torino  
(Stock # P09-15060-165)  
**OEM # D0AZ-9030-A each . . . . . 6.95**



(A)

## Gas Tank Filler Pipe Hose

1962-65 Fairlane - except Ranchero and Station Wagon  
1963 Fairlane - Station Wagon  
(Stock # F09-15110-060)  
**OEM # C5TZ-9047-B each . . . . . 15.95**  
1966 Ranchero - molded (A)  
(Stock # C09-15110-050)  
**OEM # C4DZ-9047-C each . . . . . 0.00**  
1966-69 Comet - except Station Wagon  
(Stock # M09-15110-055)  
**OEM # C4GY-9047-A each . . . . . 8.95**



## Universal Gas Filler Hose

Molded in high grade resistant rubber, with a flex joint allowing a wide variety of angles. 2" ID x 12" long. Easily trimmed to fit if your hose is missing. Great new item!  
(Stock # R09-15110-200)  
**OEM # HR-9047 each . . . . . 48.95**



## Gas Tank Vent Grommet

1966 Fairlane  
1967-71 Fairlane and Torino - except Station Wagon and Ranchero - without EV/EM  
(Stock # P09-15150)  
**OEM # B5A-9069-A each . . . . . 2.95**



## Upper Filler Tube Seal

1963-64 Fairlane Station Wagon  
(Stock # B09-15060-115)  
**OEM # C3OZ-9030-FG each . . . . . 2.95**  
1966-69 Fairlane/Torino  
(Stock # B09-15160-020)  
**OEM # C6OZ-9076-A each . . . . . 6.95**



## Gas Tank Straps

1962-65 Fairlane  
(Stock # B09-15175-065) - **Stainless Steel**  
**OEM # C2OZ-9092-SS pair . . . . . 149.95**  
1972-79 Torino  
(Stock # B09-15175-095) - **Steel**  
**OEM # D2OZ-9092-B pair . . . . . 0.00**



## Fuel Filter

1962-72 All - In Line Style  
(Stock # P09-15210-050)  
**OEM # C2RZ-9155-A each . . . . . 8.95**  
1966 Fairlane - 289 - screws into carburetor  
(Stock # P09-15210-055)  
**OEM # C5AZ-9155-B each . . . . . 5.95**  
1971-72 Torino - 351-4V  
(Stock # B09-15210-085)  
**OEM # D3OZ-9155-A each . . . . . 5.95**

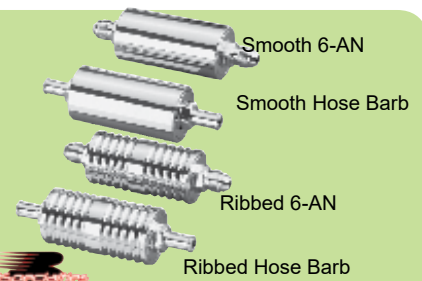

## Billet Fuel Filters

Designed for 3/8" fuel line and connects via a hose barb or 6-AM fitting. Available in smooth or ribbed styles for carbureted applications only. Mounting bracket sold separately. Uses common replaceable filter. 4 1/2" L x 1 3/8" diameter.

**Smooth**  
**Barbed - 42120 each . . . . . 55.95**  
**6-AN - 42220 each . . . . . 55.95**  
**Ribbed**  
**Barbed - 42320 each . . . . . 55.95**  
**6-AN - 42420 each . . . . . 55.95**  
Mounting bracket  
**42520 each . . . . . 23.95**



## Fuel Lines

Fuel lines for high performance - 1 x 4 bbl - carburetor setup with Holley carburetor. This is a 2 line set. Lines run from the fuel pump to the fuel filter and from the filter to the carburetor.  
1962-72 Fairlane and Comet  
(Stock # P09-15215-100)  
**OEM # C0AE-9156-AB set . . . . . 57.95**



## Fuel Filter Bracket

This bracket holds the metal canister filter.  
1966-67 Fairlane - Special 427  
(Stock # P09-15275-005)  
**OEM # C0AE-9180-A each . . . . . 29.95**



## Gas Sending Unit Float

Exactly like original in brass.  
1962-65 Fairlane  
1970-72 Torino  
(Stock # P09-15320-005)  
**OEM # C0AZ-9202-A each . . . . . 7.95**

**Price Reduced!**

*Check those prices on-line!  
See our website for current pricing.*

IF YOU HAVE ANY QUESTIONS. JUST GIVE US A RING!



Gas Tank & Fuel Related Parts

# 1962-72 Fairlane



### Gas Tank Sending Unit

1962-65 Fairlane - except Station Wagon  
(Stock # B09-15370-080)

**OEM # C2OZ-9275-B each . . . . . 49.95**



### Gas Tank Sending Unit

1966-69 Fairlane and Comet - except Ranchero

1967 Comet - 427 4V and 8V  
(Stock # B09-15370-110)

**OEM # C7OZ-9275-B each . . . . . 54.95**



### Gas Tank Sending Unit

1967 Ranchero

1968-70 Ranchero - without the low fuel warning system  
(Stock # B09-15370-130)

**OEM # D0OZ-9275-K each . . . . . 69.95**

1970-71 Fairlane and Torino - except Ranchero

(Stock # B09-15370-125)

**OEM # D0OZ-9275-M each . . . . . 99.95**



### Gas Tank Sending Unit Gasket

1962-72 Fairlane - all  
(Stock # P09-15375-015) - 2 1/2" OD

**OEM # COAF-9276-A each . . . . . 2.95**



### Gas Tank Sending Unit Locking Ring

1962-72 Fairlane - all  
(Stock # P09-15450-005) - 2 1/2" ID

**OEM # COAZ-9A307-AR each . . . . . 3.95**

Price Reduced!



### Oil Pressure Sending Unit

1962-66 Fairlane - all - for use with lights, not gauge

(Stock # P09-15385-010)

**OEM # B6A-9278-B each . . . . . 5.95**

1967 Fairlane and Comet - without gauges

(Stock # P09-15385-025)

**OEM # C7AZ-9278-B each . . . . . 5.95**

1967-71 Fairlane - All - with screw terminal

(Stock # P09-15385-030)

**OEM # C8AZ-9278-A each . . . . . 7.95**

1967 Fairlane - with gauges

1968-72 Comet - with gauges

(Stock # P09-15385-035)

**OEM # C9ZZ-9278-A each . . . . . 32.95**

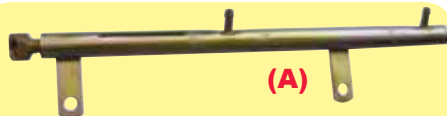

### Fuel Log Assembly

1964-73 All - 260, 289, 302, 351W - with 3 x 2 bbl carbs

(Stock # P09-15390-150)

**OEM # C5ZZ-9D280-A6V each . . 49.95**

1964-73 All - 260, 289, 302, 351W - with 2 x 4 bbl carbs

(Stock # P09-15390-155)

**OEM # C5ZZ-9D280-A8V each . . 49.95**

1964-73 All - 352, 390, 406, 427, 428 with 3 x 2 bbl carbs

(Stock # P09-15390-140)

**OEM # C1AE-9D280-A each . . . . . 49.95**

1964-73 All - 352, 390, 406, 427, 428 with 2 x 4 bbl carbs

(Stock # P09-15390-145)

**OEM # C3AZ-9D280-B each . . . . . 49.95**



### Fuel Line Support Bracket

1965-66 Fairlane - 289

(Stock # P09-15470)

**OEM # C5ZZ-9319-B each . . . . . 18.95**



### Oil Pressure Sending Unit Fitting

1962 Fairlane - 8 cylinder

1972 Torino - with tach and 351W  
(Stock # B09-15525-005)

**OEM # C2OZ-9B339-A each . . . . . 27.95**



### Fuel Pump Rebuilding Kit

1968-70 Fairlane - 428CJ

1968-71 Fairlane - 427

1969 Fairlane - 429SCJ

(Stock # P09-15555-025)

**OEM # C7AZ-9349-A each . . . . . 39.95**



### Electric Fuel Pump

12 volt - fits in-line.

1962-72 Fairlane

1966-71 Comet, Cyclone and Montego  
(Stock # P09-15560-360)

**OEM # EFP-9350-A12 each . . . . . 46.95**



Classic Auto Parts has been serving your car and truck needs since 1974!

We appreciate our customers!

# 1962-72 Fairlane



**New Fuel Pump**  
 1962-66 Fairlane - 292, 352, 390  
 (Stock # P09-15560-055) - single action (A)  
**OEM # B5A-9350-C each..... 52.95**  
 1963-65 Fairlane - 221, 260, 289  
 1963 Meteor - 221, 260, 289  
 (Stock # P09-15560-145) - single action  
**OEM # C3AE-9350-K each..... 43.95**



**New Fuel Pump**  
 1960-61 Fairlane - 352, 390  
 (Stock # P09-15560-110) - dual action  
**OEM # C0AE-9350-A each..... 116.95**



**New Fuel Pump**  
 1961 Fairlane - 292, 352, 390  
 (Stock # P09-15560-125)  
**OEM # C2AZ-9350-C each..... 18.95**



**New Fuel Pump**  
 1962 Fairlane - 170  
 1963 Meteor - 170, 200  
 (Stock # X09-15560-130)  
**OEM # C2DZ-9350-B each..... 85.95**



**New Fuel Pump**  
 1966-69 Fairlane - 289  
 1966-69 Meteor - 289, 302, 351  
 1966-67 Comet - 289  
 (Stock # P09-15560-175) - single action  
**OEM # C5AZ-9350-B each..... 62.95**



**New Fuel Pump**  
 1966 Fairlane - 390 - except Convertible  
 1967-68 Fairlane GT - 390  
 1966-69 Meteor - 352, 390, 410, 428  
 1966 Comet - 390-2V & 410-4V  
 1968 Comet/Montego - 390-2V & 410-4V  
 (Stock # P09-15560-185) Price Reduced!  
**OEM # C6AZ-9350-B each..... 39.95**

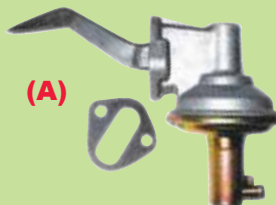

**New Fuel Pump**  
 1969 Fairlane - 390-4V  
 1968-69 Comet/Montego - 390-4V  
 1970 Meteor - 390-2V  
 (Stock # S09-15560-195)  
**OEM # C7SZ-9350-A each..... 34.95**  
 1968 Fairlane - 289, 302, 351  
 1968 Comet/Montego - 289, 302-2V - 351  
 1969 Comet/Montego - 302-2V - 351  
 1969 Montego - 302, 351W-2V  
 1970-71 Comet/Montego - 302  
 1971-72 Meteor - 302 & 351W  
 1971-72 Comet - 302 & 351W  
 1972 Montego - 302 & 351W (A)  
 (Stock # B09-15560-200)  
**OEM # C8OZ-9350-A each..... 28.95**  
 1970 Comet/Montego - 351  
 1971 Montego - 351  
 1971-72 Meteor - 400  
 1972 Montego - 351C & 400  
 (Stock # S09-15560-205)  
**OEM # C8SZ-9350-D each..... 28.95**



**Fuel Pump Filter Bowl**  
 1962-68 All  
 (Stock # P09-15575-015)  
**OEM # C3AZ-9355-A each..... 25.95**



**Fuel Pump Filter Strainer**  
 Use with filter can on pump  
 1962-64 Fairlane - All  
 1967 Fairlane GT - 390  
 (Stock # P09-15590-005)  
**OEM # C4AZ-9365-A each..... 9.95**



**Fuel Pump Mounting Gasket**  
 1962-72 All  
 (Stock # P09-15655-020)  
**OEM # C3AZ-9417-C each..... 4.95**



**Exhaust Manifold**  
 Flat flange gasket, extra heavy duty.  
 1962 Fairlane - 144, 170  
 (Stock # X09-15685-045)  
**OEM # C0DZ-9430-A each..... 159.95**



**Exhaust Manifold**  
 Donut flange gasket, extra heavy duty.  
 1963-67 Fairlane - 6 cyl  
 (Stock # B09-15685-065)  
**OEM # C3OZ-9430-ASPO each . 139.95**



# 1962-72 Fairlane

Gas Tank & Fuel Related Parts



### Exhaust Manifold

1967-68 Fairlane - 200  
 1969-72 Fairlane - 250  
 (Stock # B09-15685-095)  
**OEM # D3BZ-9430-ASPO each . 248.95**



### Exhaust Manifolds

1965 Fairlane 289 Special  
 (Stock # P09-15685-057)  
**OEM # C5ZZ-9430/1-BK set ... 349.95**

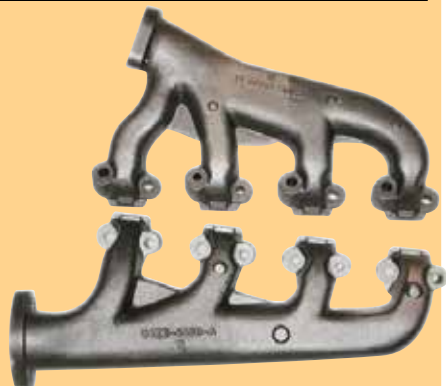

### Exhaust Manifolds

Hi Performance cast iron manifolds that will fit all engines 260, 289, 302, 351W from 1960-72. Comes with studs and nuts  
 (Stock # B09-15685-350)  
**OEM # C3OZ-9430/1-B set .... 472.95**



### Exhaust Manifolds

1968-69 Fairlane - 428CJ  
 (Stock # B09-15685-362)  
**OEM # C8OZ-9430/1-CK set ... 795.00**

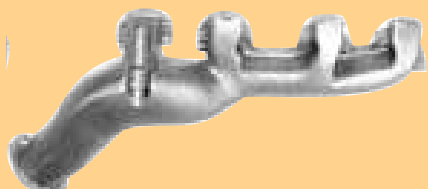

### Brass Exhaust Manifold Nuts

6 cylinder - 7/16" x 14  
 (Stock # P09-15685-035)  
**OEM # C0AZ-9430-BNA pair ..... 1.95**  
 8 cylinder - 3/8" x 16  
 (Stock # P09-15685-040)  
**OEM # C0AZ-9430-BNB pair ..... 1.95**



### Exhaust Manifold Gasket Set

1962-64 Fairlane - 221, 260  
 1963-64 Fairlane - 289  
 (Stock # P09-15700-050)  
**OEM # C3AZ-9433-D each ..... 19.95**  
 1962-68 - 260, 289  
 (Stock # P09-15745-040)  
**OEM # C2AZ-9448-K set ..... 18.95**  
 1965-72 - 240  
 (Stock # P09-15745-050)  
**OEM # C5AZ-9448-K set ..... 14.95**  
 1966-70 - 390  
 1967 - 427  
 1968-69 - 428CJ  
 (Stock # P09-15700-055)  
**OEM # C3AZ-9433-G set ..... 19.95**  
 1968-72 - 429, 460 - except Boss and CJ  
 (Stock # P09-15745-055)  
**OEM # C8AZ-9448-K set ..... 15.95**  
 1969-72 - 351W  
 (Stock # P09-15745-060)  
**OEM # C9AZ-9448-K set ..... 16.95**  
 1970-72 Torino - 429  
 (Stock # P09-15700-070)  
**OEM # C9AZ-9433-A set ..... 36.95**

**Obsolete & Classic Auto Parts, Inc.**

8701 South I-35  
 Oklahoma City, OK 73149

### Summer Store Hours:

Monday - Friday  
 8 a.m. thru 6 p.m.  
 Saturday  
 8 a.m. thru 12 p.m.

### Winter Store Hours:

Monday - Friday  
 8 a.m. thru 5 p.m.  
 Saturday  
 8 a.m. thru 12 p.m.  
 (Central Standard Time)

We accept VISA • DISCOVER  
 MASTERCARD

check us out at  
[www.classicautoparts.com](http://www.classicautoparts.com)

**NEXT DAY AIR**  
 service available  
 on ALL orders!



# 1962-72 Fairlane

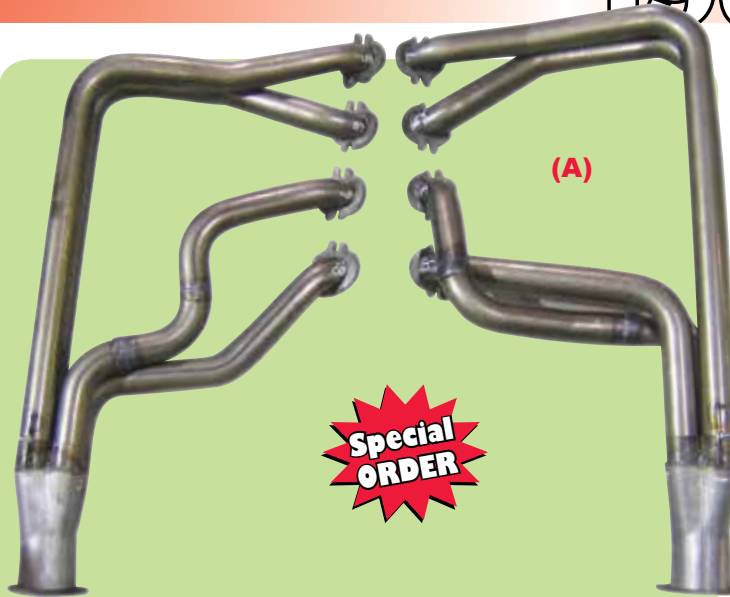

## Headers

2" Tubes with 3 1/2" Collectors

1966-71 Fairlane/Torino/Cyclone - 429/460 with power steering  
(Stock # B09-15685-060)

OEM # C60Z-9430/1-AK set ..... 595.00

1966-69 Fairlane/Comet - 390, 427, 428 Automatic or 4-speed  
NON-power steering cars  
(Stock # B09-15685-062)

OEM # C60Z-9430/1-BK set ..... 595.00

1966-69 Fairlane/Comet - 351W - Automatic or Manual Trans  
WITH Power Steering  
(Stock # B09-15685-064)

OEM # C60Z-9430/1-CK set ..... 595.00

1972-79 Torino/Ranchero/Montego - 429, 460 - Auto transmis-  
sions  
(Stock # B09-15685-091)

OEM # D20Z-9430/1-AK SET ..... 645.00



## 351W Headers

Special Order ONLY! Allow 2-4 weeks for delivery!

These have 1 3/4" diameter tubes and 3 1/2" collectors. Standard or automatic transmissions, with or without power floor shift cars only. Specify engine, transmission type, and with or without power steering.

1962-65 Fairlane

(Stock # B09-15685-348)

OEM # C20Z-9430/1-BK set ..... 595.00

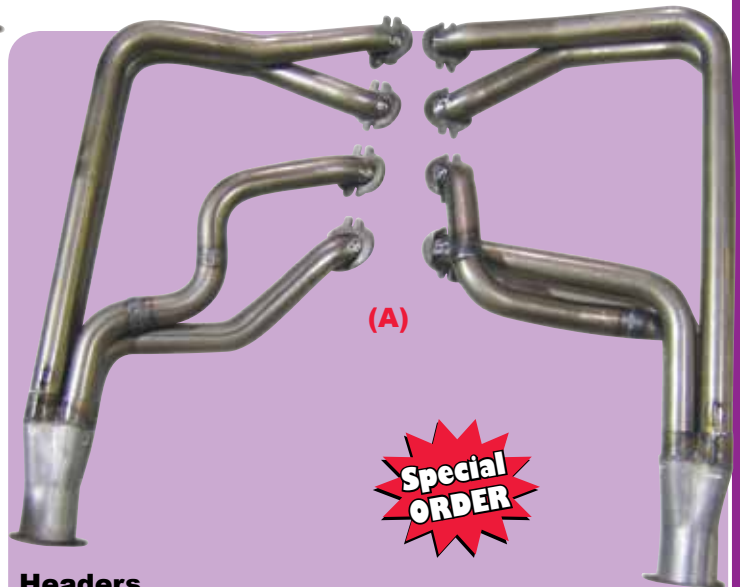

## Headers

Special Order ONLY! Allow 2-4 weeks for delivery!

2" tubes with 3 1/2" collectors

1966-71 Fairlane, Torino and Cyclone - 429 and 460 with power steering  
(Stock # B09-15685-060)

OEM # C60Z-9430/1-AK set ..... 595.00

2" tubes with 3 1/2" collectors

1966-69 Fairlane and Comet - 390, 427 and 428 automatic or 4 speed transmission without power steering  
(Stock # B09-15685-062)

OEM # C60Z-9430/1-BK set ..... 595.00

1 3/4" tubes with 3 1/2" collectors

1966-69 Fairlane and Comet - 351W with automatic or manual transmission and power steering  
(Stock # B09-15685-064)

OEM # C60Z-9430/1-CK set ..... 595.00

2" tubes with 3 1/2" collectors with custom reducers. Must use stock original mounts.

1972 Torino, Ranchero and Montego - 429 and 460 automatic transmission  
(Stock # B09-15685-090)

OEM # D20Z-9430/1-AK set ..... 645.00

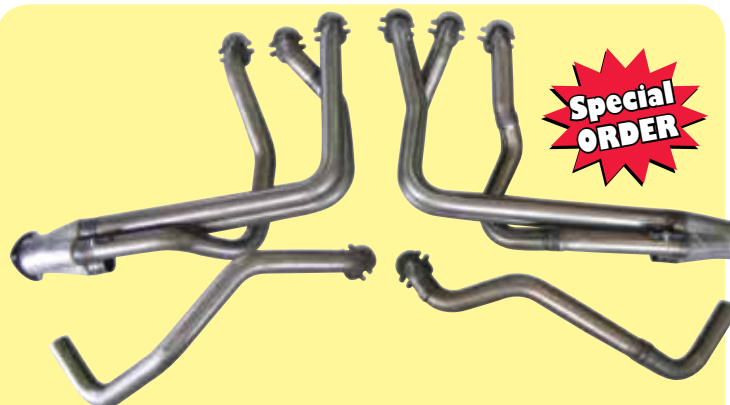

## 429/460 Headers

Special Order ONLY! Allow 2-4 weeks for delivery!

These are 2" diameter tubes, smooth flowing with 3 1/2" slip-on collectors. Includes mounting bolts. Will NOT work with power steering. If you are using a steel blow proof bell housing, a small notch cut into the bell housing will be required for header clearance. All FEE applications have 4 bolt hole flanges. Specify engine and standard or automatic transmission.

1962-65 Fairlane - 429/460

(Stock # B09-15685-347)

OEM # C20Z-9430/1-AK set ..... 595.00

# 1962-72 Fairlane



### Exhaust Manifold Spacer

1968-69 Fairlane - 428CJ with 4 bbl Carb  
(Stock # B09-15710-100)  
**OEM # C8OZ-9A435-A each . . . . 49.95**

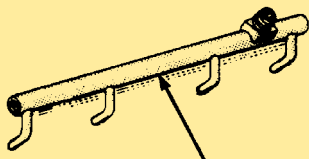

### Exhaust Air Supply Tubes

Smog tubes  
1966-68 - 170, 200  
(Stock # X09-15730)  
**OEM # C6DZ-9B445-SR set . . . . 127.95**  
1966-67 - 289  
(Stock # B09-15730-005)  
**OEM # C6OZ-9B445-R set . . . . . 91.95**



### Manifold Locking Tabs

1962-64 Fairlane - 221, 260 and 289  
1962-63 Meteor - 221, 260 and 289  
1966 Comet - 221, 260 and 289  
(Stock # B09-15740-200)  
**OEM # C2OZ-9A447-A each . . . . . 0.95**



### Carburetor to Manifold Gasket

1962-up - Ford® 2V  
(Stock # M09-15740-090)  
**OEM # C3MY-9447-A each . . . . . 3.95**  
1968-72 - 200, 240 Carter 1V  
(Stock # P09-15740-100)  
**OEM # C8AZ-9447-C each . . . . . 2.95**  
1965-68 - 289 - Ford® 2V  
1966 - 390 - Ford® 2V  
1968-72 - 302 - Ford® 2V  
1969 - 351 - Ford® 2V  
1970-72 - 351W - Ford® 2V  
(Stock # P09-15740-110)  
**OEM # D2AZ-9447-B each . . . . . 2.95**



### Exhaust Manifold to Muffler Inlet Pipe Gasket

1962-63 Fairlane  
1966-67 Fairlane - 390  
(Stock # S09-15755-010)  
**OEM # C1SZ-9450-A each . . . . . 3.95**



### Smog Tube Nut and Ferrule Set

1966-68 Fairlane  
(Stock # P09-15797-223)  
**OEM # C6AZ-9B471-A set . . . . . 37.95**



### Water Outlet Connection Cap

1966 Fairlane - 170, 200, 240 and 289  
(Stock # P09-15885)  
**OEM # C6AZ-9486-A each . . . . . 6.95**



### Exhaust Air Supply Check Valve

1966-67 Fairlane - 289, 352, 390 and 428  
1966-69 Fairlane - 170 and 200  
1970 Fairlane - 429SCJ  
(Stock # P09-15903-205)  
**OEM # C6AZ-9A487-A each . . . . 42.95**



### Vacuum Line Rubber Caps

For 1/8" tube - sold in sets of 5 pieces  
(Stock # P09-15905)  
**OEM # C9AZ-9C493-A set . . . . . 1.95**  
For 1/4" tube  
(Stock # P09-15905-005)  
**OEM # C9AZ-9C493-B set . . . . . 1.95**  
For 3/16" tube  
(Stock # P09-15905-010)  
**OEM # C9AZ-9C493-C set . . . . . 1.95**  
For 3/8" tube  
(Stock # P09-15905-015)  
**OEM # C9AZ-9C493-D set . . . . . 2.95**



### Smog Pump Filter

1966-67 Fairlane  
(Stock # P09-15910)  
**OEM # C6AZ-9A496-A each . . . . . 8.95**



### Carburetor Spacer

1963-65 Fairlane - 289, 302 - C4  
1969 Fairlane - 351/4V  
(Stock # B09-16100-009)  
**OEM # C3OZ-9A589-C each . . . . 52.95**



### Carburetor Spacer

1963-68 Fairlane - 144, 170, 200  
(Stock # F09-16100-015)  
**OEM # C3UZ-9A589-B each . . . . 54.95**



### Carburetor Adapter Kit

Will adapter a Weber 2V carb to your stock 1V intake. It enhances other up-grades such as headers, camshafts etc. Bottom holes are not drilled.  
1969-73 - 6 cylinder  
(Stock # B09-16100-036)  
**OEM # C9OZ-9A589-LGW set . . 131.95**

**1-800-654-3247**

**Call Us for  
All-American  
Deals**

# 1962-72 Fairlane

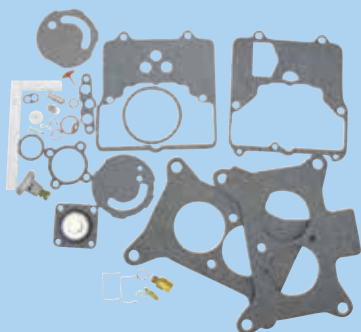

## Carburetor Rebuilding Kits

1962-72 - 221, 260, 289, 292, 302, 332, 351, 352, 390, 400, 429 - Ford® 2V  
(Stock # P09-16105-090)

**OEM # B8A-9590-K kit . . . . . 27.95**

1962-69 - 144, 170, 200 - Holley 1V #1909

(Stock # X09-16105-115) **Price Reduced!**

**OEM # C2DE-9590-A kit . . . . . 18.95**

1962-72 - 144, 170, 200, 240, 250 - Holley 1V #1940

(Stock # P09-16105-150)

**OEM # DOPF-9590-A kit . . . . . 26.95**

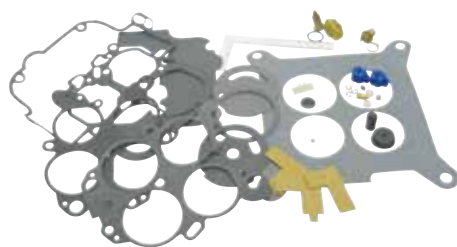

## Carburetor Rebuilding Kits

1962-72 - 289, 302, 351, 332, 352, 390, 406, 428, 429, 430 - Holley 4V  
(Stock # F09-16105-060)

**OEM # B3Q-9590-A kit . . . . . 39.95**

1962-71 - 221, 260, 289, 302, 332, 351, 390, 428, 429 - Holley 2V

(Stock # P09-16105-095) **Price Reduced!**

**OEM # B9A-9590-D kit . . . . . 26.95**

1967-69 - 170, 200 - Carter 1V

(Stock # X09-16105-135)

**OEM # C7DF-9590-T kit. . . . . 21.95**

1971-74 - 351, 429 - Ford® 4V

(Stock # B09-16105-125)

**OEM # C4OE-9590-AA kit . . . . . 48.95**

1966-72 - 289, 302, 351, 390, 428, 429, 460 - Ford® 4V

(Stock # P09-16105-130) **Price Reduced!**

**OEM # C7AF-9590-A kit . . . . . 23.95**



## Air Cleaner Wing Nut

1/4" x 20

1962-72 Fairlane and Comet

(Stock # P09-16135-080)

**OEM # C0AZ-9600-NT each. . . . . 0.95**



## Chrome Air Cleaner

This is the correct 289 High-Performance air cleaner. Includes filter and decals.

Fits All low profile 2 bbl and 4 bbl carbs. Smog tubes can be plugged for cars with open systems. Complete with attaching hardware.

1964-66 Fairlane - 289

(Stock # P09-16135-140)

**OEM # C5ZZ-9600-A each . . . . . 49.95**



## Chrome Air Cleaner

This is the correct 289 High Performance air cleaner. Includes filter and decals. Fits all low profile 2 bbl and 4 bbl carburetors. Smog tubes can be plugged for cars with open systems. Complete with attaching hardware.

Fairlane and Comet - 289

(Stock # P09-16135-140)

**OEM # C5ZZ-9600-A each . . . . . 49.95**



## Air Intake Tube Set

To use with cast aluminum air bonnet.

Specify year, engine size and 2-4 medium or 2-4 high rise. These are made to order. Allow 2 weeks for shipping time.

1962-65 Fairlane

(Stock # B09-16220-100) **Price Reduced!**

**OEM # C2OZ-9654-IT set. . . . . 379.95**



## Air Cleaner Elements

1962-64 - 144, 170, 200, 223

(Stock # P09-16140-035)

**OEM # C1KE-9601-A each . . . . . 9.95**

1962-63 - 221, 260

1964 - 260 except Sprint Special

1965-67 - 289

1968 - 289, 302

(Stock # B09-16140-040)

**OEM # C2OZ-9601-A each. . . . . 9.95**

1963-64 Fairlane - 289-4V

(Stock # S09-16140-025)

**OEM # B7SZ-9601-A each . . . . . 13.95**

1967 - 170, 200

1968 - 200

1969 - 250

(Stock # P09-16140-090)

**OEM # C8ZZ-9601-A each . . . . . 6.95**

1969-71 - 289, 302

1969 - 390

1969-70 - 351

1971 - 351C, 400

(Stock # P09-16140-080)

**OEM # C8AZ-9601-A each. . . . . 16.95**

1970-72 - 250

(Stock # P09-16140-095)

**OEM # C9ZZ-9601-A each . . . . . 9.95**



## Cast Aluminum T-Bolt Air Bonnet

Filter sold separately. Specify engine and carburetor: 1 X 4V - 2 X 4V or high rise or Dominator.

1962-65 Fairlane - Lightning bolt

(Stock # B09-16135-102)

**OEM # C2OZ-9600-AB each . . . 549.95**

# 1962-72 Fairlane

Gas Tank & Fuel Related Parts



## Oval Air Cleaner Assembly

These are cast aluminum as the original Ford® 6V and 8V carbs had. Notice they are available for single or multiple carbs units. Correct emblems for these will be listed in 16228 section. These are correct for applications 1961-68 and will also fit many other years. They are available with or without the cutout for the engine bird emblem. All comes complete with attaching hardware and a 1 3/4" high air cleaner element.

### With Cutout for Bird Emblem

Fits single 4 bbl

1961-68 Ford® and Mercury® - all  
(Stock # P09-16135-105) - **with cutout**

OEM # C3AZ-9600-4V each. . . . 209.95

Fits 3 x 2 bbl carbs

1961-68 Ford® and Mercury® - all  
(Stock # P09-16135-110) - **with cutout**

OEM # C3AZ-9600-6V each. . . . 209.95

Fits 2 x 4 bbl carbs

1961-68 Ford® and Mercury® - all  
(Stock # P09-16135-115) - **with cutout**

OEM # C3AZ-9600-8V each. . . . 209.95

### With Plain Top - No Cutout

Fits single 4 bbl

1961-68 Ford® and Mercury® - all  
(Stock # P09-16135-125) - **plain top**

OEM # C3AZ-9600-P4V each. . . 209.95

Fits 3 x 2 bbl carbs

1961-68 Ford® and Mercury® - all  
(Stock # P09-16135-130) - **plain top**

OEM # C3AZ-9600-P6V each. . . 209.95

Fits 2 x 4 bbl carbs

1961-68 Ford® and Mercury® - all  
(Stock # P09-16135-135) - **plain top**

OEM # C3AZ-9600-P8V each. . . 209.95

**Don't forget to join our e-mail list. We send out e-mail specials, and you don't want to miss out!**



## Oval Air Cleaner Element

1 3/4" high - designed for the oval air cleaners  
(Stock # P09-16140-185)

OEM # EDJ-9601-A each . . . . . 26.95



## Carburetor Air Cleaner Air Duct Shroud and Tube Assembly

1968 Fairlane - 289

1968-72 Fairlane - 302 except non-emission

1968-72 Comet - 289 and 302

(Stock # P09-16150-035)

OEM # C8AZ-9A603-C each. . . . 108.95



## Carburetor Air Cleaner Hot Air Tube Assembly

1969 Fairlane - 390-4V

1969-70 Fairlane - 250

1969-72 Comet and Montego - 250, 351, 390

1970 Fairlane - 302 and 390-2V

1970-71 Comet and Montego - 302, 351, 390, 400

1970-71 Fairlane - 429CJ-4V

1970-72 Fairlane - 429

1971-72 Torino - 302 and 351

(Stock # F09-16215)

OEM # C9UZ-9652-A each. . . . . 14.95



## Air Cleaner to Carburetor Gasket

1962-64 Fairlane

(Stock # P09-16225-010)

OEM # C0AZ-9654-A each. . . . . 2.95



## Tri-Power Air Cleaner to Carburetor Mounting Gasket

1962-72 Fairlane - fits tri-power oval air cleaners.

(Stock # P09-16225-020)

OEM # C1AZ-9654-TP each . . . . . 4.95



## Air Cleaner Top Cover Seal

1962-69 Fairlane - 6 cylinder

(Stock # P09-16255-005)

OEM # C3AZ-9673-A each. . . . . 4.95

I want you to check out our website for easy shopping and current prices for anything you may need. Don't want to order on-line? Just give us a call and we'll be happy to help!



**Call Us:**  
**1-800-654-3247**

# 1962-72 Fairlane



## Ram Air Shaker Plug

Mounts in the shaker drain hole located on the top surface. Injection molded plastic to OEM specifications.

1970-71 Torino and Ranchero - 351 or 429 Ram air

(Stock # B09-16290)

**OEM # D00Z-9D699-A each . . . . . 0.00**

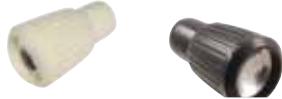

## Dash Knobs

1962 Fairlane - early - white with chrome insert

(Stock # X09-16295-160)

**OEM # C0DB-9700-W each . . . . . 7.95**

1962-64 Fairlane - black - air vent knob

(Stock # P09-16295-155)

**OEM # C0AZ-9700-B each . . . . . 7.95**

Check out our Swap Meet Schedule to see when we will be close. Maybe even save some on shipping. Call one of the guys for more information!



## Carburetor Linkage Rod Kit

Includes all linkage parts for 3 x 2 barrel set-up, bellcrank, bellcrank to carburetor rod, front throttle rod and rear throttle rod.

1961-66 - 390, 406 and 427

(Stock # P09-16295-165)

**OEM # C1AE-9700-LRK kit. . . . . 69.95**

Includes all linkage parts for 2 x 4 barrel set-up, bellcrank, bellcrank to carburetor rod, front throttle rod and rear throttle rod.

1963-64 - 406 and 427 low riser engine only

(Stock # P09-16295-195)

**OEM # C3AZ-9700-LRK kit. . . . . 69.95**

Includes all linkage parts for 3 x 2 barrel set-up, bellcrank, bellcrank to carburetor rod, front throttle rod and rear throttle rod.

1963-69 - 260, 289 and 302

(Stock # P09-16295-210)

**OEM # C5ZZ-9700-LRK set . . . . . 69.95**

This kit also fits the small block engines with 2 x 4 barrels. You must turn your carburetors around to install on the 260, 289 and 302. This will then give you progressive linkage, which is much better than the original. Includes all linkage parts for 2 x 4 barrel set-up, bellcrank, bellcrank to carburetor rod, front throttle rod and rear throttle rod.

1965-68 - 427 and 428 medium riser, high riser, tunnel port, and cammer

(Stock # P09-16295-205)

**OEM # C5AZ-9700-LRK set . . . . . 69.95**



## Gas Pedal to Accelerator Linkage Rod

1962-64 Fairlane - using the C0DD-9735-A

(Stock # S09-16375-020)

**OEM # B7A-9727-B each . . . . . 0.00**



## Accelerator Bellcrank Assembly

With 3 x 2 barrels

1961-67 - 390, 406 and 427

(Stock # P09-16360)

**OEM # C1AE-9724-A each . . . . . 39.95**

With 2 x 4 barrels

1963-65 - 406 and 427 lower riser engine

(Stock # P09-16395)

**OEM # C3AZ-9732-C each . . . . . 39.95**

With 3 x 2 barrels

1963-67 - 260, 289 and 302

(Stock # P09-16395-010)

**OEM # C5ZZ-9732-A6V each . . . . . 39.95**

With 3 x 2 barrels

1965-67 - 427 medium riser, high riser, tunnel port and crammer

(Stock # P09-16395-005)

**OEM # C5AZ-9732-A each . . . . . 39.95**

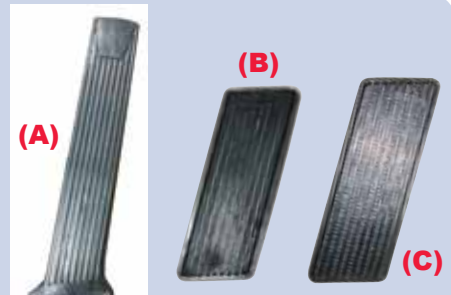

## Accelerator Pedal

1962-65 Fairlane

1962-63 Meteor

(Stock # X09-16410-070) - molded rubber

**OEM # C0DD-9735-A each . . . . . 14.95**

1966-67 Fairlane and Comet

(Stock # P09-16410-100) - with chrome trim

**OEM # C5ZZ-9735-D each . . . . . 12.95**

1968-71 Fairlane

(Stock # B09-16410-105) - molded plastic

**OEM # C80Z-9735-B each . . . . . 15.95**

An American Classic!

Gas Tank & Fuel Related Parts

# 1962-72 Fairlane



## Street Rod Style Accelerator Pedal

Ford® and Mercury® All  
(Stock # V09-16410-060)  
**OEM # B-9735-STL each . . . . . 147.95**



## Accelerator Return Spring

1966-68 Fairlane - 289  
1967-68 Fairlane - 289, 302, 390, 428 and 428CJ  
(Stock # P09-16420-060)  
**OEM # C5ZZ-9737-B each . . . . . 4.95**



## Accelerator Retracting Spring and Extension

This kit includes the accelerator shaft return spring and the accelerator retracting spring.  
1962-72 Fairlane  
1966-71 Comet  
(Stock # P09-16420-065)  
**OEM # C7AZ-9737-A each . . . . . 44.95**



## Carburetor Throttle Lever Trunnion

Fits on carburetor lever and on some linkages. Made with nut on back for easy removal.  
1963-67 Fairlane - 406 and 427 with 2 x 4V  
(Stock # P09-16470-010)  
**OEM # C3AZ-9C760-A each . . . . . 8.95**



## Accelerator Pedal Spring

1966-68 Fairlane - before 4/25/68  
(Stock # P09-16470)  
**OEM # C5ZZ-9760-B each . . . . . 0.95**



## Carburetor Rod

Accelerator to bellcrank  
1963-69 - 260, 289, 302 - 3 x 2V  
(Stock # P09-16495-005)  
**OEM # C5ZZ-9772-A6V each . . . . . 12.95**  
1962-up - 352, 390, 406 - 3 x 2V  
(Stock # P09-16495)  
**OEM # C1AE-9772-A each . . . . . 12.95**



## Accelerator Pedal Rod Seal

1962-65 Fairlane  
(Stock # B09-16535-015)  
**OEM # C2OZ-9793-A each . . . . . 23.95**



## Accelerator Pedal Rod Seal

1966-69 Fairlane/Torino  
(Stock # B09-16535-040) **Price Reduced!**  
**OEM # C6OZ-9793-B each . . . . . 1.95**



## Accelerator Pedal Lever Pivot Bushing

1972 Fairlane  
(Stock # P09-16560)  
**OEM # C5AZ-9C805-A each . . . . . 3.95**



## Accelerator Rod End Clip

1962-72 Fairlane/Torino  
**Right hand** - (Stock # P09-16590)  
**OEM # B7A-9825-B each . . . . . 95**  
**Left hand** - (Stock # P09-16593-050)  
**OEM # B7A-9826-A each . . . . . 95**



## Front Carburetor Throttle Rod

1961-67 - 406 and 427  
1962-69 - 260, 289 and 302  
(Stock # P09-16605) - **with 3 x 2 barrels (A)**  
**OEM # C1AE-9B841-A each . . . . . 12.95**  
1963-67 - 406 and 427 lower riser, medium riser, high riser, tunnel port and crammer  
(Stock # P09-16605-005) - **with 2 x 4 barrels (B)**  
**OEM # C3AZ-9B841-B each . . . . . 12.95**

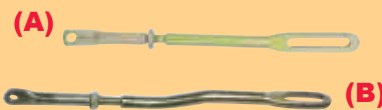

## Rear Carburetor Throttle End

1961-67 - 390, 406 and 427  
1963-69 - 260, 289 and 302  
(Stock # P09-16610) - **with 3 x 2 barrels (A)**  
**OEM # C1AE-9B842-A each . . . . . 14.95**  
1963-67 - 406 and 427 lower riser, medium riser, high riser, tunnel port and crammer  
(Stock # P09-16610-005) - **with 2 x 4 barrels (B)**  
**OEM # C3AZ-9B842-B each . . . . . 14.95**



## Thermostatic Choke Control Outlet Tube Insulator

Glass fiber - 23.13" long  
1963-64 Fairlane - 289 Special 4V  
1962-63 Meteor  
1966-71 Comet, Cyclone and Montego  
(Stock # P09-16650-025)  
**OEM # C1AE-9865-A each . . . . . 18.95**

# 1962-72 Fairlane



### Generator Rebuild Kit

Includes armature, brush set, field coils, and front and rear bearings.

1962-64 Fairlane

(Stock # P10-17010-020)

**OEM # B6A-10002-K each . . . . . 41.95**



### Rebuilt Generators

1962-65 Fairlane - 144, 170

(Stock # X10-17010-025)

**OEM # C1DF-10002 each . . . . . 184.95**



### Generator End Plate Bearing

1962-64 Fairlane

(Stock # P10-17100-015)

**OEM # A8AZ-10094-B each . . . . . 21.95**



### Generator Rear Bearing

1962-64 Fairlane

(Stock # P10-17105-005)

**OEM # B6A-10095-B each . . . . . 14.95**



### Generator Thru Bolt

1962-65 Fairlane

(Stock # P10-17165-015)

**OEM # C3AZ-10120-A each . . . . . 2.95**



### Alternator Bracket

1970-72 Torino - 302, 351W, 351C

(Stock # B10-17255)

**OEM # D0OZ-10156-A each . . . . . 15.95**



### Generator Splash Shield

5 11/16" OD

1962-64 Fairlane - 6 cylinder

1962-63 Meteor - 6 cylinder

(Stock # P10-17265-005)

**OEM # C1AZ-10170-B each . . . . . 29.95**



### Generator Outer Splash Shield

Includes attaching staples

1964 Fairlane - 260, 289

(Stock # B10-17265-010)

**OEM # C4OZ-10170-C each . . . . . 13.95**



### New Alternators

Original style reproductions. Show quality units. All units produce 61 amps regardless of markings. **Limited quantities available, please call.**

1965 Fairlane - 289 Hi-Po

(Stock # P10-17285-005) - **42 amp**

**OEM # C5AF-10300-D each . . . . . 199.95**

1967 - 200, 289 with power steering

(Stock # X10-17285-055) - **38 amp**

**OEM # C6DF-10300-A each . . . . . 199.95**

1967-68 Fairlane - 390 without T/E

(Stock # F10-17285-070) - **38 amp**

**OEM # C6TF-10300-A each . . . . . 199.95**



### Alternator Pulley

1965 Fairlane - 289 Hi-Performance

(Stock # P10-17315-045)

**OEM # C5ZZ-10344-R each . . . . . 44.95**



### Alternator Nut and Washer

1965-66 Fairlane

(Stock # P10-17315-038)

**OEM # C5ZZ-10344-ZKT each . . . . . 5.95**

1967-71 Fairlane and Torino

(Stock # P10-17315-037)

**OEM # C5ZZ-10344-DKT each . . . . . 5.95**



### Alternator Pigtail Wires

1965-72 All

(Stock # P10-17320-005)

**OEM # C5AZ-10346-PT each . . . . . 4.95**

**Our standard ground service is shipped by FedEx. If you desire another carrier, let us know when you place your order, and we'll get you the details.**



# 1962-72 Fairlane

Generator & Battery Parts



### Standard Voltage Regulator

30 Amp  
1962-64 Fairlane - with generator  
(Stock # P10-17340-045)  
OEM # B6A-10505 each ..... **99.95**  
Price Reduced!



### Standard Voltage Regulator

1964 Fairlane with alternator  
1965-72 All - except solid state ignition systems  
(Stock # S10-17310)  
OEM # C3SZ-10316-A each ..... **49.95**



### Authentic Reproduction Voltage Regulators

Original colors with original style stamping. All are correct and show quality.  
1962-72 All  
Blue Cover with Yellow Autolite  
(Stock # F10-17340-080)  
OEM # C8TF-10505-AA each .... **49.95**  
Black Cover with Yellow FoMoCo  
(Stock # F10-17340-060)  
OEM # C3TF-10505-B each ..... **66.95**  
Black Cover with Silver Autolite  
(Stock # P10-17340-065)  
OEM # C5AF-10505-AA each ... **49.95**



### Voltage Regulator to Firewall Grommets

Rubber grommets with brass inserts.  
1960-65 Fairlane  
(Stock # V10-17380)  
OEM # 91A-10610-S3P set ..... **3.95**



### Autolite Battery Cover

Gives modern batteries an original look. Injection molded. Fits over any flat top battery.  
10½" wide x 7" high  
1962-72 Fairlane  
1966-71 Comet and Montego  
(Stock # Z10-17390-030)  
OEM # M-10655-BC each ..... **78.95**



### 12 Volt Automatic Battery Storage Float Charger

Keep your battery charged while its in storage  
(Stock # V10-17390-021)  
OEM # B-10655-FCH each ..... **29.95**  
Price Reduced!



### Battery Terminal Washer

Felt washer on top of each battery terminal post. Oil impregnated to resist corrosion.  
1962-72 Fairlane and Comet  
(Stock # P10-17420-005)  
OEM # C1AZ-10A717-A each .... **2.95**

**We accept these MAJOR credit cards.**



(A)



(B)



### Battery Hold Down Clamp

Die stamped steel - EDP coated  
1962-65 Fairlane - 40 & 45 amp batteries  
(Stock # X10-17425-030)  
OEM # C2DZ-10718-C each ..... **4.95**  
1964-66 Fairlane - 55 amp batteries  
(Stock # X10-17425-055)  
OEM # C5DZ-10718-KIT each .... **8.95**  
1966-70 Fairlane/Torino  
1966-67 Comet  
1968-70 Montego  
(Stock # P10-17425-035)  
OEM # C5AZ-10718-A each ..... **6.95**  
Price Reduced!



### Battery Hold Down Clamp

1970-73 Fairlane/Torino - before 6-1-73  
(Stock # B10-17425-075)  
OEM # D0OZ-10718-A each .... **14.95**  
1970-71 Comet & Montego  
(Stock # X10-17425-065)  
OEM # D0DZ-10718-A each .... **11.95**



### Battery Hold Down Bracket

1962-66 Fairlane & 1966 Comet  
(Stock # X10-17425-045)  
OEM # C5DZ-10718-A each ..... **2.95**



### Battery Clamp Bolt Kit

Black anodized for rust prevention. Kit includes correct hex flange nuts. 3 piece kit  
1962-66 Fairlane & 1966 Comet  
(Stock # X10-17425-063)  
OEM C5DZ-10K718-K kit ..... **1.95**  
Price Reduced!

**Friend us on Facebook and follow us on Twitter. You never know what you might be in for.**

# 1962-72 Fairlane



### Battery Tray

Die stamped steel - EDP coated  
1966-67 Fairlane - 390  
(Stock # P10-17465-015)

**OEM # C9AZ-10764-A each . . . . 24.95**



### Battery Tray

Die stamped - EDP coated  
1966-69 Fairlane - 200, 250, 289, 302,  
351 without AC  
(Stock # B10-17450-095)

**OEM # C7OZ-10732-B each . . . . 29.95**



### Battery Tray

Die stamped - EDP coated  
1970-71 Fairlane/Torino - all  
(Stock # B10-17450-105)

**OEM # D0OZ-10732-B each . . . . 15.95**



### Battery Tray

Die stamped steel - EDP coated  
1972-76 Fairlane and Montego  
1972-79 Torino and Rancho  
(Stock # B10-17450-110)

**OEM # D2OZ-10732-A each . . . . 29.95**

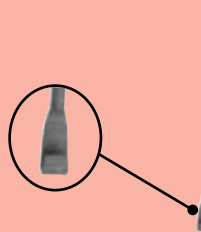

### Battery Clamp Mounting Kit

J-hooks and nuts  
1962-72 All  
(Stock # P10-17455-050)

**OEM # D0AZ-10756-K kit . . . . . 4.95**



### Instrument Cluster Voltage Regulator

1965 Fairlane  
(Stock # M10-17475-020)

**Price Reduced!**

**OEM # B9MZ-10804-C each . . . . 25.95**

1966-68 Fairlane  
1969 Fairlane - with tachometer  
1966-68 Comet and Montego  
(Stock # X10-17475-025)

**OEM # C6DZ-10804-A each . . . . 24.95**

1969-71 Fairlane - without tachometer  
1972 Torino - with Ralley instrument group  
1969-70 Comet and Montego  
(Stock # P10-17475-035)

**OEM # C9AZ-10804-A each . . . . 25.95**

1972 Torino - without Ralley instrument group  
(Stock # P10-17475-040)

**OEM # D1AZ-10804-A each . . . . 24.95**



### Temperature Sending Bulb

1962-63 Fairlane - before 11-16-62  
(Stock # P10-17555-010)

**OEM # B7A-10884-A each . . . . . 26.95**

1963-66 Fairlane  
(Stock # P10-17555-025)

**OEM # C3AZ-10884-A each . . . . . 8.95**

1966-67 Fairlane - 8 cylinder  
1968 Fairlane - 8 cylinder - except 427  
(Stock # P10-17555-030)

**OEM # C5AZ-10884-B each . . . . . 57.95**

**Online order is available 24/7!**

**www.ClassicAutoParts.com**

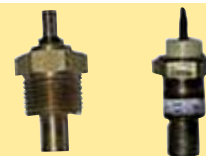

### Temperature Sending Unit

1966-67 Fairlane - 6 cylinder  
1966-68 Comet - with gauges  
(Stock # X10-17555-035)

**OEM # C6DZ-10884-B each . . . . . 8.95**

1968 Fairlane - 427  
1969 Fairlane - All  
1970 Fairlane - 8 cylinder  
(Stock # M10-17555-040)

**OEM # C8GY-10884-A each . . . . . 28.95**

1970-72 Fairlane - 302 - with gauges  
(Stock # P10-17555-055)

**OEM # D0ZZ-10884-A each . . . . . 45.95**



### Rebuilt Starter Motor

1965-71 Fairlane - 240  
(Stock # F11-18005-040)

**OEM # C5TF-11002 each . . . . . 79.95**



### Starter Terminal Posts

Includes terminal post insulators & all hardware.

For oval terminal post hole  
(Stock # V11-18120)

**OEM # 18-11102-O each . . . . . 12.95**

For round terminal post hole  
(Stock # V11-18120-005)

**OEM # 18-11102-R each . . . . . 9.95**



Classic Auto Parts has been serving your car and truck needs since 1974!

We appreciate our customers!

# 1962-72 Fairlane



## Starter Drive End Bushing

1962-64 Fairlane  
 (Stock # X11-18170-098) **New!**  
**OEM # CODZ-11135-A each..... 2.95**



## Starter Solenoid

1962-71 Fairlane and Comet  
 (Stock # P11-18235-065)  
**OEM # B6A-11450-A each..... 12.95**



## Ignition Switches

Cylinder and keys sold separately  
 1962-64 Fairlane  
 (Stock # P11-18295-025) **(A)**  
**OEM # C3AZ-11572-A each..... 11.95**  
 1965 Fairlane and Comet  
 (Stock # F11-18295-035)  
**OEM # C7UZ-11572-A each..... 15.95**  
 1966-67 Fairlane and Comet  
 (Stock # P11-18295-030) **(B)**  
**OEM # C5AZ-11572-B each..... 19.95**  
 1968-69 Fairlane and Torino  
 1968-70 Comet  
 (Stock # P11-18295-060) **(C)**  
**OEM # D1AZ-11572-C each..... 15.95**  
 1971 Torino  
 (Stock # P11-18295-050)  
**OEM # D1AZ-11572-A each..... 21.95**  
 1972 Torino  
 (Stock # B11-18295-065)  
**OEM # D2OZ-11572-A each..... 0.00**

**Air service is available on any shipment. We understand you are in a hurry. Inquire when placing your order. We have several options.**



## Ignition Switch Lock Cylinder and Key Set

1962-65 Fairlane  
 (Stock # P11-18330-015) **Price Reduced!**  
**OEM # C3AZ-11582-A set..... 6.95**



## Ignition Switch Lock Cylinder and Key Set

1966-69 Fairlane  
 1966-70 Comet and Montego  
 (Stock # P11-18330-025) **(A)**  
**OEM # C9AZ-11582-A set..... 8.95**  
 1970-72 Fairlane  
 1970-71 Torino  
 1970-71 Comet, Cyclone and Montego  
 (Stock # P11-18330-030) **(B)**  
**OEM # D2AZ-11582-B set..... 11.95**



## Ignition Switch Bezel

1962-65 Fairlane  
 1962-63 Meteor  
 1968-70 Comet and Montego  
 (Stock # P11-18340-005) **(A)**  
**OEM # C3AZ-11584-A each..... 7.95**  
 1966-67 Fairlane and Comet  
 (Stock # B11-18340-015) **(B)**  
**OEM # C6OZ-11584-A each..... 13.95**

**I want you to check out our website for easy shopping and current prices for anything you may need. Don't want to order on-line? Just give us a call and we'll be happy to help!**

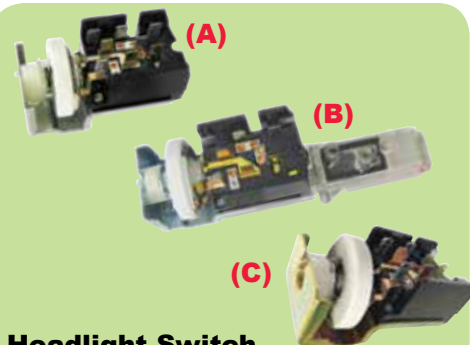

## Headlight Switch

1962-64 Fairlane  
 (Stock # P11-18400-025)  
**OEM # C0AF-11654-C each..... 44.95**  
 1965-69 Comet  
 (Stock # P11-18400-105) **(C) Price Reduced!**  
**OEM # D3ZZ-11654-A each..... 14.95**  
 1965-69 Fairlane  
 1970-71 Torino - without hidden head lamps  
 1972 All **(A)**  
 (Stock # P11-18400-100)  
**OEM # D3AZ-11654-A each..... 17.95**  
 1970 Montego - 4 door Sedan, 2 and 4 door Hardtop, and 4 door Station Wagon - with hidden headlights  
 1970-71 Torino - with hidden headlights  
 1971 Cyclone - with hidden headlights  
 (Stock # P11-18400-090) **(B)**  
**OEM # C8AZ-11654-A each..... 68.95**



## Headlight Switch Knob With Shaft

**White with 3 1/8" long shaft**  
 1962 Fairlane - early  
 (Stock # B11-18415-095) **Price Reduced!**  
**OEM # C2OZ-11661-W each..... 9.95**  
**Black with 3 1/8" long shaft**  
 1962 Fairlane - late  
 1963-64 Fairlane  
 (Stock # B11-18415-090) **(A)**  
**OEM # C2OZ-11661-B each..... 9.95**

**1-800-654-3247**  
**Call Us for**  
**All-American**  
*Deals*

# 1962-72 Fairlane



### Breakerless Ignition System

This solid-state system will replace the points and condenser system.  
 1962-67 Fairlane - 6 cylinder without smog pump and with single point distributor  
 (Stock # RB8-38000-010)  
**OEM # SR-12000-1266 each . . . 108.95**



### Tune Up Kit

Includes points, rotor and condenser  
 1962-67 Fairlane - 6 cylinder  
 (Stock # P12-19000-030)  
**OEM # A7A-12000-B set . . . . . 14.95**  
 1962-71 - 8 cylinder - without dual points  
 (Stock # F12-19000-045)  
**OEM # C0TZ-12000-B set . . . . . 17.95**  
 1968-71 Fairlane - 6 cylinder Price Reduced!  
 1966-70 Comet - 6 cylinder  
 (Stock # P12-19000-050)  
**OEM # C5AZ-12000-D set . . . . . 15.95**



### Ignition Coil

Replacement - 12V unit - all black  
 1962-72 All - except transistorized ignition  
 (Stock # P12-19030-015)  
**OEM # B6A-12029-RP each. . . . . 19.95**



### Mustard Top Ignition Coil

Original style - OEM correct  
 1962-72 Fairlane/Torino  
 (Stock # P12-19030-016) Price Reduced!  
**OEM # B6AZ-12029 each . . . . . 37.95**



### Distributor Cap

1962-71 Fairlane - 6 cylinder  
 1966-70 Comet - 6 cylinder  
 (Stock # P12-19080-015)  
**OEM # 7HA-12106 each . . . . . 7.95**



### Distributor Cap

1962-74 Fairlane - 8 cylinder  
 1966-70 Comet - 221, 260, 289  
 (Stock # P12-19080-020)  
**OEM # B7A-12106-A each. . . . . 6.95**



### Ignition Point Sets

1962-71 Fairlane - 6 cylinder Price Reduced!  
 (Stock # P12-19205)  
**OEM # 7RA-12171 set . . . . . 4.95**  
 2 sets required for dual point  
 1962-71 Fairlane - 8 cylinder  
 1966-71 Comet - 8 cylinder  
 (Stock # P12-19205-005)  
**OEM # B7A-12171 set . . . . . 4.95**



### Distributor Rotor

1962-67 Fairlane - 6 cylinder  
 (Stock # P12-19260-070)  
**OEM # FAA-12200-B each. . . . . 4.95**  
 1962-71 Fairlane - 8 cylinder  
 (Stock # P12-19260-020)  
**OEM # B7A-12200-A each. . . . . 3.95**  
 1968-71 Fairlane - 6 cylinder  
 (Stock # F12-19260-035)  
**OEM # C5TZ-12200-B each . . . . . 6.95**



### Distributor Wiring

Primary terminal wiring  
 1962 Fairlane - 6 cylinder  
 (Stock # P12-19290)  
**OEM # 7RA-12216 each . . . . . 15.95**



### Fuse Panel

So you can install fuses between wires to eliminate fire - four gang style.  
 Ford® and Mercury® All  
 (Stock # VB8-30000-010)  
**OEM # B-12251-4 . . . . . 10.95**

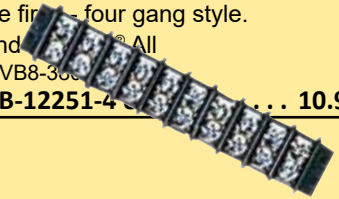

### Terminal Block

Allows you to link wires and add additional accessories. 10 connection capacity.  
 Ford® and Mercury® All  
 (Stock # V12-19335)  
**OEM # B-12252 each. . . . . 16.95**



### Wiring Circuit Breaker

61½" long - 20 gauge wire - coded pink  
 1962-68 Fairlane  
 (Stock # P12-19330-030)  
**OEM # COLF-12250-A each . . . . . 32.95**  
 1969-72 Fairlane  
 1969-70 Comet  
 (Stock # B12-19330-040)  
**OEM # C9OZ-12250-A each. . . . . 0.00**



### Spark Plug Wires

1965-70 Fairlane - 390, 427 steel core  
 (Stock # P12-19345-090)  
**OEM # C5AZ-12259-AK set . . . . . 0.00**  
 1967 Fairlane - 6 cylinder  
 (Stock # P12-19345-125)  
**OEM # C7AZ-12259-AK set . . . . . 52.95**

# 1962-72 Fairlane



## Spark Plug Wires

Original color boots, correct sleeving and date codes on each reproduction set

1968-71 Fairlane - 6 cylinder

(Stock # P12-19345-170)

**OEM # C8AZ-12259-AK set . . . . . 52.95**

1968-70 Fairlane - 390, 428 with smog

(Stock # P12-19345-185)

**OEM # C8AZ-12259-DK set . . . . . 58.95**

1969-71 Fairlane - 351W

(Stock # P12-19345-190)

**OEM # C9AZ-12259-AK set . . . . . 69.95**

1970-71 Fairlane - 351C

(Stock # B12-19345-195)

**OEM # D00Z-12259-AK set. . . . . 0.00**



## Spark Plug Wire Separator

Mounts on the valve cover

1965-72 Fairlane - all

(Stock # F12-19375-005)

**OEM # B8Q-12297-A each . . . . . 1.95**



## Spark Plug Wire Separator

Comb shaped - 8 prongs

1962-72 Fairlane - all

(Stock # P12-19375)

**OEM # B6A-12297-A each. . . . . 95**



## Spark Plug Wire Grommet

4 holes in square - 1/4" long - use with the #FAA-12112-A bracket.

1962-64 Fairlane

(Stock # P12-19375-045)

**OEM # FAA-12297-A each. . . . . 2.95**



## Distributor Condenser

1962-67 Fairlane - 6 cylinder

(Stock # P12-19390-020)

**Price Reduced!**

**OEM # 7RA-12300 each . . . . . 2.95**

1962-71 - 8 cylinder - without dual points

(Stock # P12-19390-050)

**OEM # B7A-12300-C each. . . . . 4.95**

1968-71 Fairlane - 6 cylinder

(Stock # P12-19390-047)

**OEM # B9AZ-12300-A each. . . . . 17.95**

1962-71 Fairlane - 390, 427, 428, 429 -

with dual points

(Stock # P12-19390-055)

**OEM # C9AZ-12300-A each. . . . . 18.95**



## Distributor Bushing

This pilot bore bushing is bronze with a steel back and is used in the engine block when a 1/4" intermediate distributor shaft is used.

1960-63 Fairlane - 144 and 170

1962-64 Fairlane - 200

(Stock # F12-19425)

**OEM # C4TZ-12367-A each . . . . . 29.95**



## Distributor Vacuum Diaphragm

1962-67 Fairlane - 8 cylinder dual ad-

vance distributor

(Stock # P12-19430-015)

**OEM # B9AF-12370-A each. . . . . 55.95**



## Distributor Vacuum Diaphragm

1965-72 Fairlane

(Stock # P12-19430-025)

**OEM # C5AZ-12370-A each. . . . . 0.00**



## Distributor Vacuum Diaphragm

1968-72 Fairlane

(Stock # P12-19430-030)

**OEM # C8AZ-12370-A each. . . . . 24.95**



## Spark Plugs

1960-64 Fairlane - 6 cylinder

1960-66 Fairlane - 223

1962-64 Fairlane - 221 and 260

1962-66 Fairlane - 200

1965 Fairlane -240

1965-66 Fairlane - 240

1967-68 Fairlane - 289

1969-70 Fairlane - 302, 390 and 402

1971-72 Torino - 302, 390 and 460

1966-70 Comet and Montego - 200, 250

(Stock # P12-19445-020)

**OEM # B7A-12405-A each. . . . . 2.95**

1960-64 Fairlane - 352, 390 and 427

1962-64 Fairlane - 289 2 bbl

1966-70 Comet and Montego - 289, 302,

351 and 390

1969-70 Comet - 429

(Stock # P12-19445-030)

**OEM # B8A-12405-A each. . . . . 2.95**

1965-70 Fairlane - 250

1971-72 Torino - 170, 200 and 250

(Stock # P12-19445-040)

**OEM # C1AZ-12405-C each. . . . . 2.95**

1968-70 Fairlane - 240

1971-72 Fairlane - 429

(Stock # P12-19445-055)

**OEM # D0AZ-12405-A each . . . . . 1.95**



## Neutral Safety/Backup Light Switch Wire

1965 Fairlane

(Stock # B12-19476-120)

**OEM # C5OZ-12638-A each. . . . . 74.95**



# 1962-72 Fairlane



**New!**

### Halogen Headlight Bulb with Turn Signals

7 inch quartz halogen bulb with built in turn signals or park lights.

1962-72 Fairlane and Comet - all  
(Stock # V13-20000-201)

**OEM # B-13000-WTS pair . . . . . 54.95**



(A)



(B)

### Headlight Bulb

1962-64 Fairlane - type #4001 - high beam

(Stock # P13-20030-070) - 5 1/4" diameter

**OEM # B8AZ-13007-B each . . . . . 19.95**

1962-71 All - type #4002 - low beam (A)

(Stock # P13-20030-065) - 5 3/4" diameter (A)

**OEM # B8AZ-13007-A each . . . . . 9.95**

1965-71 All - type #5006 - high beam

(Stock # P13-20030-090) (B)

**OEM # D2AZ-13007-B each . . . . . 15.95**

1972 Torino - type # 5001 - low beam

(Stock # P13-20030-085)

**OEM # D2AZ-13007-A each . . . . . 9.95**

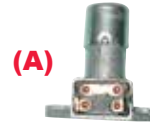

(A)



(B)

### Head Lamp Dimmer Switch

Use with above pigtail wiring - also used as a reverberation type rear seat speaker switch

1962-72 All - without automatic dimmer  
(Stock # F13-20075-025)

**OEM # C0TZ-13A024-A each . . . . . 7.95** (A)

1968-69 All - with automatic dimmer relay  
(Stock # M13-20080-020)

**OEM # C8VY-13A025-A each . . . 42.95** (B)



### Head Lamp Adjusting Spring

1962-63 & 1972 Fairlane

(Stock # B13-20110-015)

**OEM # C2OZ-13031-A each . . . . . 2.95**

1966-71 Fairlane and Torino

1968-71 Comet and Montego - requires 2 each side

(Stock # P13-20110-025)

**OEM # C6AZ-13031-C each . . . . . 1.95**



### Head Lamp Visor

Chrome plated

7 1/2" diameter - (Stock # A13-20020)

**OEM # A-13004-A each . . . . . 5.95**

5 3/4" diameter - (Stock # A13-20020-005)

**OEM # A-13004-B each . . . . . 5.95**

**Friend us on Facebook and follow us on Twitter. You never know what you might be in for.**



### Head Lamp Bulb Retaining Ring

Inner ring with tabs. These tend to rust out so replacing is a must!

1967-72 Fairlane and Torino

1966-70 Comet and Montego

(Stock # P13-20050)

**OEM # C7AZ-13015-B each . . . . . 9.95**



### Head Lamp Adjusting Nut Bracket

1962-64 Fairlane

(Stock # B13-20070-015)

**OEM # C2OZ-13021-A each . . . . . 1.95**



### Headlight Door Seal

Original style grey rubber

1966-67 Fairlane - All

(Stock # B13-20125-010)

**OEM # C6OZ-13038-A each . . . . . 1.95**



### Head Lamp Doors

Die stamped anodized aluminum as original.

1966 Fairlane

(Stock # B13-20190-130) - right hand

**OEM # C6OZ-13064-A each . . . 259.95**

(Stock # B13-20190-135) - left hand

**OEM # C6OZ-13064-B each . . . 259.95**

**Service with a**



Classic Auto Parts has been serving your car and truck needs since 1974!

We appreciate our customers!

# 1962-72 Fairlane



## Headlight Socket and Pigtail

11" long - not original but a great replacement piece.

1962-72 Fairlane and Torino

1966-71 Comet and Montego

(Stock # V13-20215-005)

**OEM # 01A-13076-U each. . . . . 2.95**



Front

Back

## Headlight Adjusting Ring

Low beams

1967 Fairlane

(Stock # P13-20215-125) - right hand

**OEM # C8AZ-13118-A each. . . . . 21.95**

(Stock # P13-20215-126) - left hand

**OEM # C8AZ-13119-A each. . . . . 21.95**



## Parking Light Lenses

1962-63 Fairlane - fits either side

(Stock # X13-20370-195) - clear

**OEM # C2DB-13208-B each . . . . . 5.95**

(Stock # X13-20370-210) - amber

**OEM # C3DZ-13208-A each. . . . . 7.95**



## Parking Light Lenses

1964-65 Fairlane - fits either side

(Stock # P13-20370-205) - clear

**OEM # C3AZ-13208-B each. . . . . 7.95**

(Stock # B13-20370-230) - amber

**OEM # C4OZ-13208-A each. . . . . 7.95**



## Parking Light Lens

Amber colored with FoMoCo embossed in the plastic.

1966-67 Fairlane

(Stock # B13-20370-046) - right hand

**OEM # C6OZ-13208-A each. . . . . 11.95**

(Stock # B13-20375-037) - left hand

**OEM # C6OZ-13209-A each. . . . . 11.95**



## Parking Light Lenses

1968-69 Fairlane

(Stock # B13-20370-265) - right hand

**OEM # C8OZ-13208-B each. . . . . 29.95**

(Stock # B13-20375-055) - left hand

**OEM # C8OZ-13209-B each. . . . . 29.95**



## Parking Light Lenses

These are sold in a pair - Amber in color

1969 Ranchero

(Stock # F13-20370-345)

**OEM # C7TZ-13208/9-B pair. . . . . 39.95**



## Parking Light Lens

1969 Fairlane Talladega

(Stock # F13-20370-275) - fits either side

**OEM # D1UZ-13208-A each . . . . . 9.95**



## Parking Light Lenses

Clear with Ford® script on the lens.

1970 Fairlane and Torino

(Stock # B13-20020-200) - right hand

**OEM # D0OZ-13208-A each . . . . . 42.95**

(Stock # B13-20020-300) - left hand

**OEM # D0OZ-13209-A each . . . . . 41.95**



## Parking Light Lenses

Amber with Ford® script on the lens.

1971 Torino

(Stock # B13-20020-250) - right hand

**OEM # D1OZ-13208-A each . . . . . 42.95**

(Stock # B13-20020-325) - left hand

**OEM # D1OZ-13209-A each . . . . . 42.95**

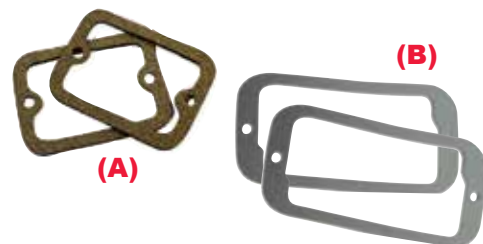

(A)

(B)

## Parking Light Lens Gaskets

1962-63 Fairlane

(Stock # X13-20385-110)

**OEM # C2DB-13211-A pair . . . . . 2.95**

1964-65 Fairlane

(Stock # P13-20385-090)

**OEM # C1AB-13211-A pair . . . . . 4.95**

1966 Ranchero

(Stock # X13-20385-145)

**OEM # C6DZ-13211-B pair . . . . . 0.00**

1966-67 Fairlane

(Stock # B13-20385-150)

**OEM # C6OZ-13211-A pair . . . . . 4.95**

1968-69 Fairlane and Torino

(Stock # B13-20385-175)

**OEM # C8OZ-13211-A pair . . . . . 6.95**

1969 Fairlane - Talladega

1969 Montego - Spoiler II

(Stock # F13-20385-075)

**OEM # B9C-13211-B pair . . . . . 5.95**

1970-71 Fairlane and Torino

(Stock # B13-20385-190)

**OEM # D0OZ-13211-A pair . . . . . 4.95**

1971-72 Comet and Montego

(Stock # M13-20385-185)

**OEM # C9WY-13211-A pair. . . . . 1.95**

1972 Torino

(Stock # B13-20385-197)

**OEM # D2OZ-13211-AS pair . . . . . 4.95**



## Parking Light Body to Fender Pad

1969 Fairlane - Talladega #63

(Stock # F13-20405-040)

**OEM # C9TZ-13217-A each . . . . . 11.95**

# 1962-72 Fairlane



## Turn Signal Switch Knob

Early 1962 Fairlane - White - no insert  
(Stock # X13-20460-060) **(A)**  
**OEM # C0DZ-13305-A each . . . . . 7.95**  
 Late 1962 Fairlane - Black  
(Stock # P13-20460-050)  
**OEM # C0AZ-13305-B each . . . . . 7.95**  
 1963-64 Fairlane - Black - no insert  
(Stock # P13-20460-035) **(B)**  
**OEM # B7A-13305-B each . . . . . 7.95**

**(A)**

## Turn Signal Lever

1962 Fairlane - not exact reproduction  
(Stock # B13-20460-080)  
**OEM # C2OZ-13305-R each . . . . . 0.00**  
 1963-64 Fairlane - large thread  
(Stock # C13-20480-015)  
**OEM # C4DZ-13310-A each . . . . . 9.95**  
 1965-72 Fairlane and Torino  
(Stock # P13-20460-105) **(A)**  
**OEM # D0AZ-13305-A each . . . . . 9.95**

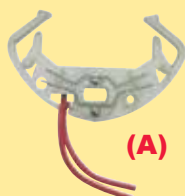

## Turn Signal Cam Repair Kit

This just replaces the worn-out cam instead of the entire assembly.  
 1962-64 Fairlane and Torino - without 8 cylinder and 4 speed transmission  
 1965 Fairlane and Torino - without floor shift  
 1965-66 Fairlane - with floor shift  
 1966 Comet - without tilt wheel  
(Stock # X13-20505-025) **(A)**  
**OEM # C3DZ-13318-A each . . . . . 11.95**  
 1963-64 Fairlane - 8 cylinder 4 speed  
(Stock # S13-20505-035)  
**OEM # C4SZ-13318-A each . . . . . 11.95**  
 1967 Fairlane  
 1968-69 Fairlane and Torino - without tilt wheel  
 1970-71 Torino  
(Stock # S13-20505-040)  
**OEM # C7SZ-13318-B each . . . . . 11.95**  
 1971-73 Torino **Price Reduced!**  
(Stock # P13-20505-055)  
**OEM # D0AZ-13318-A each . . . . . 11.95**

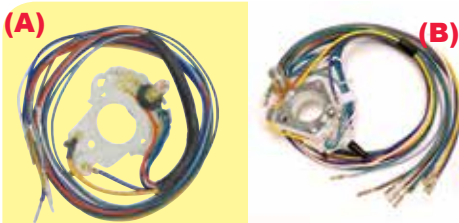

## Turn Signal Switch and Mounting Plate Assembly

This includes the wiring going down the steering column.  
 1962-64 Fairlane - except 8 cylinder with 4 speed transmission  
(Stock # B13-20540-075)  
**OEM # C3OZ-13341-B each . . . . . 55.95**  
 1963-64 Fairlane - 8 cylinder with 4 speed transmission  
(Stock # P13-20540-070)  
**OEM # C3AZ-13341-C each . . . . . 83.95**  
 1965 Fairlane - except floor shift  
(Stock # B13-20540-085) **(A)**  
**OEM # C5OZ-13341-B each . . . . . 24.95**  
 1965 Fairlane - with floor shift  
 1966 Fairlane - all  
(Stock # M13-20540-095)  
**OEM # C5VY-13341-B each . . . . . 99.95**  
 1967 Fairlane  
(Stock # P13-20540-105)  
**OEM # C7ZZ-13341-F each . . . . . 97.95**  
 1968-69 Fairlane - with fixed column  
(Stock # P13-20540-120)  
**OEM # C9AZ-13341-B each . . . . . 99.95**  
 1970-71 Fairlane and Torino **Price Reduced!**  
(Stock # P13-20540-170) **(B)**  
**OEM # D2AZ-13341-C each . . . . . 155.95**  
 1972-73 Torino  
(Stock # B13-20540-180)  
**OEM # D3OZ-13341-A each . . . . . 86.95**  
 1974-76 Torino - tilt wheel  
(Stock # B13-20540-200)  
**OEM # D6OZ-13341-A each . . . . . 149.95**



## Turn Signal Flasher

1962-65 Fairlane  
 1966-69 Fairlane - except Station Wagon  
(Stock # P13-20560-015) **(A)**  
**OEM # C5AZ-13350-B each . . . . . 5.95**  
 1966-68 Fairlane - Station Wagon  
 1972 Torino - all  
(Stock # P13-20560-020) **(B)**  
**OEM # C6AZ-13350-B each . . . . . 4.95**



## LED Flasher

2 prong style - 12V  
(Stock # V13-20560-003)  
**OEM # B-13350-2 each . . . . . 12.95**  
 3 prong style - 12V  
(Stock # V13-20560-004)  
**OEM # B-13350-3 each . . . . . 12.95**

**New!**



## Emergency Flasher Wiring

1966 Fairlane  
(Stock # P13-20560-023)  
**OEM # C6AZ-13A350-A each . . . . . 91.95**



## Turn Indicator Lamp Assembly

1969 Torino - fits either side  
(Stock # P13-20565-095)  
**OEM # C9ZZ-13A355-A each . . . . . 58.95**



## Rear Marker Reflector Assembly

1968 Comet - after 2/15/68  
(Stock # M13-20590-013)  
**OEM # C8GY-13380-A each . . . . . 54.95**



## Tail Light Housing Plug and Pigtail

1965-66 Fairlane  
(Stock # B13-20635-005) - left hand  
**OEM # C4OZ-13A408-AL each . . . . . 12.95**  
 (Stock # B13-20635-010) - right hand  
**OEM # C4OZ-13A408-AR each . . . . . 12.95**

# 1962-72 Fairlane



### Replacement Style Parking Light Socket and Wire

1962-64 Fairlane  
(Stock # F13-20645-090) Price Reduced!  
**OEM # BAAA-13410 each . . . . . 3.95**



### Park and Turn Signal Wire

1965-69 Fairlane  
(Stock # B13-20645-100)  
**OEM # C5OZ-13410-B each. . . . . 0.00**



### Tail Light Socket and Wire

1971-2 Fairlane and Torino - except Ranchero or Station Wagon  
(Stock # P13-20645-110)  
**OEM # D1AZ-13410-B each. . . . . 9.95**



### Tail Light to Body Gaskets

1963 Fairlane  
1964 Fairlane - Station Wagon  
(Stock # B13-20670-140)  
**OEM # C3OZ-13420-A pair . . . . . 41.95**  
1964 Fairlane - except Station Wagon  
(Stock # B13-20670-155)  
**OEM # C4OZ-13420-A pair . . . . . 34.95**



### Tail Light to Body Gaskets

1966 Fairlane - except Station Wagon  
(Stock # B13-20895-045)  
**OEM # C6OZ-13520-C each. . . . . 19.95**



(A)

### Tail Light to Body Gaskets

1967 Fairlane - except Ranchero or Station Wagon  
(Stock # B13-20895-050) (A)  
**OEM # C7OZ-13520-A pair . . . . . 21.95**  
1967 Ranchero and Station Wagon - except with reflectors  
(Stock # B13-20895-055)  
**OEM # C7OZ-13520-B pair . . . . . 17.95**



(A)

### Tail Light to Body Gaskets

1968-69 Ranchero and Station Wagon  
(Stock # B13-20895-060) (A)  
**OEM # C8OZ-13520-B pair . . . . . 21.95**  
1968-69 Torino Fastback  
(Stock # B13-20895-062)  
**OEM # C8OZ-13520-C pair . . . . . 39.95**  
1970-71 Ranchero  
(Stock # B13-20895-064)  
**OEM # D0OZ-13520-AB pair . . . . . 23.95**  
1972-79 Ranchero  
(Stock # B13-20895-090)  
**OEM # D2OZ-13520-AB pair . . . . . 23.95**

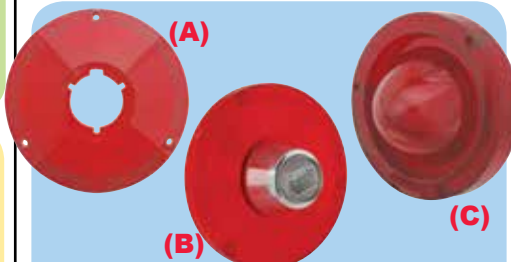

(A)

(B)

(C)

### Tail Light Lens

Ford® script all red lens.  
1962 Fairlane - with hole backup lights  
(Stock # B13-20745-410) (A)  
**OEM # C2OB-13450-B each . . . . . 24.95**  
1962 Fairlane - with backup assembly  
(Stock # B13-20870) (B)  
**OEM # C2OB-13A497-B each . . . . . 45.95**  
1962 Fairlane - without backup lights  
(Stock # B13-20745-420) (C)  
**OEM # C2OZ-13450-B each. . . . . 34.95**



(A)

(B)

### Tail Light Lenses

1963 Fairlane - without backup light  
(Stock # B13-20745-445) (A)  
**OEM # C3OZ-13450-A each. . . . . 9.95**  
1963 Fairlane Deluxe - with chrome ring  
(Stock # B13-20745-450) (B)  
**OEM # C3OZ-13450-B each. . . . . 15.95**



### Tail Light Lens

Ford® script - fits either side  
1965 Fairlane with backup lights  
(Stock # B13-20745-525)  
**OEM # C5OZ-13450-C each. . . . . 69.95**



### Tail Light Lens

Fits either side with white bottom lens.  
1966 Comet  
(Stock # M13-20745-545)  
**OEM # C6GY-13450-A each. . . . . 41.95**



### Tail Light Lens

Ford® script - fits either side  
1966 Fairlane  
(Stock # B13-20745-555)  
**OEM # C6OZ-13450-C each. . . . . 104.95**

# 1962-72 Fairlane



## Tail Light Lens

Molded with FoMoCo® logo  
1967 Fairlane  
(Stock # B13-20745-575) - fits either side  
**OEM # C7OZ-13450-A each. . . . . 53.95**



## Tail Light Lens

Complete with backup light section  
1968-69 Torino Fastback body #63  
(Stock # B13-20745-595) - fits either side  
**OEM # C8OZ-13450-C each. . . . . 102.95**



## Glass Dots

With stainless rim. Fits all years and any lens.

### Blue Dot

(Stock # V13-20745-145)  
**OEM # B-13450-GBD each . . . . . 3.95**

### Red Dot

(Stock # V13-20745-150)  
**OEM # B-13450-GRD each . . . . . 3.95**

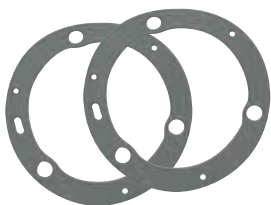

## Tail Light Lens Gasket

1962 Fairlane - except Station Wagon  
(Stock # B13-20770-125)  
**OEM # C2OB-13461-A pair . . . . . 3.95**

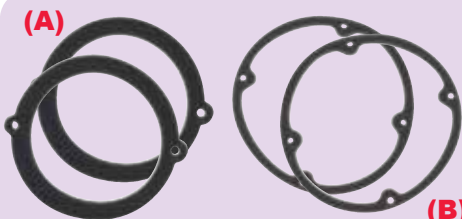

## Tail Lamp Lens Gaskets

1963 Fairlane except Station Wagon

**Without backup lights**  
(Stock # B13-20770-150) **(A)**  
**OEM # C3OZ-13461-A pair . . . . . 7.95**

**With backup lights**  
(Stock # B13-20770-155) **(B)**  
**OEM # C3OZ-13461-B pair . . . . . 8.95**



## Tail Light Lens Gaskets

1964 Fairlane  
(Stock # C13-20770-165) **(A)**  
**OEM # C4OZ-13461-A pair . . . . . 7.95**

1965 Fairlane - except Station Wagon  
(Stock # B13-20770-210) **(B)**  
**OEM # C5OZ-13461-A pair . . . . . 9.95**

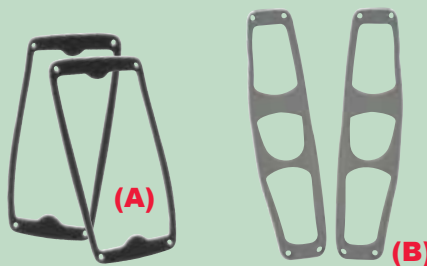

## Tail Light Lens Gaskets

1966 Fairlane - except Station Wagon  
(Stock # B13-20770-235) **(A)**  
**OEM # C6OZ-13461-C pair . . . . . 9.95**

1966 Fairlane Station Wagon - only  
(Stock # B13-20770-240) **(B)**  
**OEM # C6OZ-13461-D pair . . . . . 8.95**

1966 Comet  
(Stock # M13-20770-230)  
**OEM # C6GY-13461-A pair . . . . . 8.95**



## Tail Light Lens Gaskets

1966-67 Ranchero - with reflectors  
(Stock # X13-20770-225) **(A)**  
**OEM # C6DZ-13461-B pair . . . . . 8.95**

1967 Fairlane - except Station Wagon and Ranchero  
(Stock # B13-20770-270) **(B)**  
**OEM # C7OZ-13461-A pair . . . . . 4.95**

1967 Comet  
(Stock # M13-20770-265)  
**OEM # C7GY-13461-AB set . . . . . 4.95**

1967 Ranchero and Station Wagon  
(Stock # B13-20770-275) - without reflector  
**OEM # C7OZ-13461-B pair . . . . . 9.95**



## Tail Light Lens Gaskets

1968-69 Ranchero and Station Wagon  
(Stock # B13-20770-295)  
**OEM # C8OZ-13461-A pair . . . . . 12.95**



## Light Bulbs

The industry standard number is stamped into the housing of every bulb. We will try and list some of the more common applications, but by simply looking at the bulb housing you can identify the bulb # that you are needing. Call for additional information.

**#1034 - 12V double contact**  
1962-72 All - parking light  
(Stock #P13-20785-070)

**OEM # B6A-13465-A each. . . . . .95**  
**#1073 - 12 single contact**  
(Stock # P13-20785-075)

**OEM # B6A-13465-B each. . . . . .95**  
**#1141 - 12V single contact**  
(Stock # P13-20785-080)

**OEM # B8E-13465-A each. . . . . .95**  
**#1076 - 12V double contact**  
1966 Station Wagon - backup lamp  
(Stock # F13-20785-085)

**OEM # C1TB-13465-A each. . . . . .95**

*Check our prices on-line!  
See our website for current pricing.*



Lighting Parts

# 1962-72 Fairlane



## Light Bulbs

The industry standard number is stamped into the housing of every bulb. We will try and list some of the more common applications, but by simply looking at the bulb housing you can identify the bulb # that you are needing.

- #89 - 12V single contact**  
(Stock # P13-20790-030)  
**OEM # B5AZ-13466-A each . . . . . .95**
- #57 - 12V single contact**  
1965-66 - heater control panel  
1967-72 -steering column shift  
(Stock # P13-20790-035)  
**OEM # B6A-13466-A each . . . . . .95**
- #1445 - 12V single contact**  
1966-70 - ash tray lamp  
1966-72 - transmission selector dial  
1967-72 - cigar light  
1971 - console courtesy lamp  
(Stock # P13-20790-040)  
**OEM # B6A-13466-B each . . . . . 0.95**
- #1003 - 12V single contact**  
1965-69 - interior cargo lamp  
(Stock # P13-20790-045)  
**OEM # B6AZ-13466-A each . . . . . .95**
- #1816 - 12V single contact**  
1966-69 - console courtesy lamp  
1971 - ash tray  
1972 - glove box lamp  
(Stock # P13-20790-050)  
**OEM # B8AZ-13466-A each . . . . . .95**
- #1892 - 12V single contact**  
1965-66 - radio lamp  
1971 - console ash tray lamp  
(Stock # M13-20790-055)  
**OEM # B9MY-13466-A each . . . . . 3.95**
- #1891 - 12V single contact**  
1970-71 - glove box lamp  
1971 - A/C control lamp  
(Stock # S13-20790-060)  
**OEM # B9SZ-13466-A each . . . . . .95**
- #1893 - 12V single contact**  
1971 - glove box lamp  
(Stock # M13-20790-065)  
**OEM # C1VY-13466-A each . . . . . .95**
- #194 - 12V single contact**  
1969-72 - body side lamp  
1968-72 - instrument panel  
1970-72 - seat belt warning lamp  
1970-72 - warning lamps  
(Stock # P13-20790-070)  
**OEM # C2AZ-13466-C each . . . . . .95**



## Light Bulbs

- #1895 - 12V single contact**  
1965-72 - warning lamps  
(Stock # P13-20790-085)  
**OEM # C3AZ-13466-B each . . . . . .95**
- #161 - 12V wedge style**  
1970-71 - ash tray / marker lamp  
(Stock # P13-20790-095)  
**OEM # C3AZ-13466-D each . . . . . .95**
- #97 - 12V single contact**  
1960-72 - license plate lamp  
(Stock # P13-20790-100)  
**OEM # C3AZ-13466-G each . . . . . .95**
- #1156 - 12V - single contact**  
1965-72 - backup lamp  
1969 - rear lamp and bumper lamp  
(Stock # X13-20790-105)  
**OEM # C3DZ-13466-A each . . . . . .95**
- #1004 - 12V - double contact**  
(Stock # S13-20790-115)  
**OEM # C3SZ-13466-A each . . . . . .95**
- #631 - 12V - single contact**  
1965-72 - courtesy lamp  
1966-72 - engine lamp  
1965-71 - map lamp  
(Stock # M13-20790-120)  
**OEM # C3VY-13466-A each . . . . . 1.95**
- #53 - 12V - double contact**  
1967-68 - turn indicator lamp  
(Stock # S13-20790-130)  
**OEM # C4SZ-13466-C each . . . . . .95**
- #1142 - 12V - double contact**  
(Stock # P13-20790-135)  
**OEM # C5ZZ-13466-A each . . . . . .95**
- #90 - 12V - double contact**  
1968 - front door courtesy lamp  
(Stock # S13-20790-145)  
**OEM # C6SZ-13466-A each . . . . . .95**
- #1196 - 12V - double contact**  
(Stock # M13-20790-140)  
**OEM # C6MY-13466-A each . . . . . 0.95**
- #168 - 12V - single contact**  
(Stock # S13-20790-150)  
**OEM # C7SZ-13466-B each . . . . . .95**
- #1157 - 12V - double contact**  
1965-67 - parking lamp  
1969 Talladega - parking lamp  
1965-68 & 1971-72 - tail light  
(Stock # F13-20790-160)  
**OEM # C8TZ-13466-A each . . . . . .95**
- #1157A - 12V - double contact**  
(Stock # P13-20790-165)  
**OEM # C9AZ-13466-A each . . . . . .95**

**Don't forget to join our e-mail list. We send out e-mail specials, and don't want you to miss out!**



## Light Bulbs

- #194A - 12V - wedge** Price Reduced!  
(Stock # X13-20790-170)  
**OEM # C9DZ-13466-A each . . . . . .95**
- #1157NA - 12V - double contact**  
1968-70 - fender parking lamp  
(Stock # M13-20790-175)  
**OEM # C9MY-13466-A each . . . . . 0.95**
- #105 - 12V - single contact**  
1969-72 - dome and map light  
1970 - luggage compartment lamp  
1970-72 - cargo light  
(Stock # P13-20790-180)  
**OEM # DOAZ-13466-A each . . . . . 1.95**
- #562 - 12V - single contact**  
1970-71 - instrument panel  
(Stock # P13-20790-185)  
**OEM # DOZZ-13466-A each . . . . . 3.95**
- #561 - 12V - double contact**  
1972 - dome and map lamp  
(Stock # P13-20790-190)  
**OEM # D1AZ-13466-A each . . . . . 2.95**
- #211-2 - 12V - double contact**  
(Stock # F13-20790-195)  
**OEM # D1FZ-13466-B each . . . . . 2.95**
- #563 - 12V - wedge**  
(Stock # P13-20790-200)  
**OEM # D2AZ-13466-A each . . . . . 3.95**
- #214 - 12V - double contact**  
(Stock # S13-20790-205)  
**OEM # D2SZ-13466-A each . . . . . 4.95**
- #67 - 12V - single contact**  
(Stock # V13-20790)  
**OEM # 09B-13466-A each . . . . . .95**
- OEM U-13465-TL each . . . . . 13.95**



## Lamp Bulb Pliers

Avoid needless hazards in bare-handed removal of corrosion seized bulbs with dangerously brittle or loose glass. Anyone will appreciate these high quality pliers specially designed for the job. Angled jaws allow easy access to bulbs in small, tight places.

(Stock # P13-20785-200)  
**OEM U-13465-TL each . . . . . 13.95**

**Online order is available 24/7!  
www.ClassicAutoParts.com**

**Obsolete & ClassicAutoParts, Inc.**

# 1962-72 Fairlane

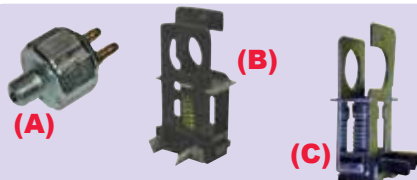

## Stop Light Switch

- 1962-64 Fairlane  
(Stock # V13-20840) **(A)**  
**OEM # 11A-13480 each . . . . . 5.95**
- 1965 Fairlane - manual brakes  
(Stock # P13-20840-025) **(A)**  
**OEM # C5AZ-13480-A each. . . . . 25.95**
- 1965 Fairlane - with power brakes  
(Stock # M13-20840-045) **(B)**  
**OEM # C9VY-13480-A each. . . . . 5.95**
- 1965 Fairlane - manual brakes  
(Stock # P13-20840-050) **(C)**  
**OEM # C9ZZ-13480-A each. . . . . 4.95**
- 1966-71 Fairlane and Torino - manual brakes  
(Stock # B13-20840-040)  
**OEM # C9OZ-13480-A each. . . . . 16.95**

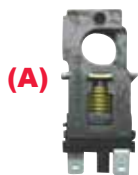

## Stop Light Switch

- 1969 Fairlane - with power brakes  
(Stock # P13-20840-035) **(A)**  
**OEM # C9AZ-13480-D each. . . . . 14.95**
- 1972 Torino - manual brakes  
(Stock # P13-20840-055)  
**OEM # D1ZZ-13480-A each. . . . . 10.95**
- 1972 Torino - power brakes  
(Stock # P13-20840-060)  
**OEM # D1ZZ-13480-B each. . . . . 4.95**



## Brake Light Switch Retainer Clip

- 1966-71 Fairlane  
(Stock # )  
**OEM # 380699-S100 each. . . . . .95**

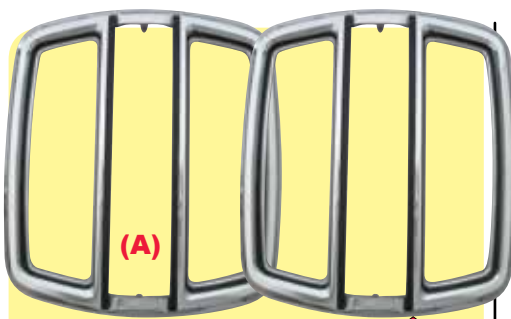

## Tail Light Bezel Set

- Die stamped aluminum reproduction. **New!**  
1966 Fairlane  
(Stock # B13-20850-053)  
**OEM # C6OZ-13489-A/B set . . . . 56.95**
- 1968-69 Fairlane, Torino, Talledega Fast-back only  
(Stock # B13-20850-076) **(A)**  
**OEM # C8OZ-13489-E pair . . . . 319.95**



## Tail Light Wiring Retainer

- 1 7/16" long curved plate with two 1/8" holes and 7/16" long prongs.  
1967-70 Fairlane  
1972 Fairlane and Torino  
(Stock # P13-20875-015)  
**OEM # C7AZ-13A506-S each. . . . . 2.95**



## Head Lamp Dimmer Switch Cap

- Molded rubber cover which fits over the foot style head lamp dimmer switch.  
1970-72 Fairlane and Torino  
(Stock # P13-20905)  
**OEM # C5ZZ-13533-A each . . . . . 3.95**



## License Plate Light Assembly

- Includes the housings, gauge, gasket and cover complete.  
1962-64 Fairlane  
(Stock # P13-20915-023)  
**OEM # C0DZ-13550-A each. . . . . 35.95**



## License Plate Light Assembly

- Includes housing, cover, lens and gasket  
1965-69 Fairlane  
(Stock # P13-20915-024)  
**OEM # C4AZ-13550-A each. . . . . 41.95**



## License Plate Housing

- 1962-64 Fairlane - includes socket  
(Stock # X13-20935-036)  
**OEM # C3AZ-13560-A each. . . . . 19.95**
- 1965-69 Fairlane - does not include socket  
(Stock # X13-20935-038)  
**OEM # C4AZ-13560-A each. . . . . 19.95**



## License Lamp Lenses

- 1962-64 Fairlane  
(Stock # X13-20940-021)  
**OEM # C0DF-13564-A each. . . . . 11.95**
- 1962-63 Meteor - except Station Wagon  
(Stock # F13-20940-025) **(B)**  
**OEM # C1TB-13564-A each. . . . . 11.95**
- 1965-69 Fairlane and Torino  
(Stock # P13-20940-030) **(A)**  
**OEM # C4AZ-13564-A each. . . . . 9.95**



## License Plate Lamp Cover

- Metal  
1962-64 Fairlane  
(Stock # P13-20790-063)  
**OEM # C1AZ-13566-A each. . . . . 5.95**
- 1965-69 Fairlane  
(Stock # B13-0925-200) **(A)**  
**OEM # C5OZ-13566-B each. . . . . 5.95**



# 1962-72 Fairlane



**License Lamp Lens Gasket**  
 1962-64 Fairlane  
 (Stock # P13-20960-019)  
**OEM # B9A-13568-A each. . . . . 1.95**  
 1965-72 Fairlane and Torino - except  
 Ranchero and Station Wagon  
 1966-67 Comet  
 1971 Comet and Montego (A)  
 (Stock # P13-20960-030)  
**OEM # C7AZ-13568-A each. . . . . .95**



**Third Brake Light Assembly**  
 Machined from Billet aluminum. Ready to  
 install. 12 volts. 6 $\frac{7}{8}$ " wide.  
 Ford® and Mercury® All Street Rod  
 (Stock # P13-20990)  
**OEM # BA-13613-BA each . . . . . 69.95**



**Interior Lamp Switch Wiring**  
 1965 Fairlane  
 (Stock # B13-21020-120)  
**OEM # C5OB-13A709-B each . . . 57.95**



**Front Door Courtesy Lamp  
 Wire** New!  
 1964-65 Fairlane 500 - Tudor  
 (Stock # B13-21035-012)  
**OEM # C4OB-13B712-A each . . . 48.95**



(B)

**Instrument Panel Lamp Socket**  
 1966 Fairlane (A)  
 (Stock # P13-21030)  
**OEM # C7AZ-13711-A each. . . . . 4.95**  
 1968-72 Fairlane  
 1968-71 Comet and Montego (B)  
 (Stock # B13-21030-010)  
**OEM # C8OZ-13711-A each. . . . . 2.95**

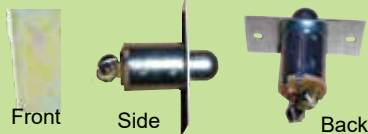

**Aftermarket Door Jamb  
 Switch**  
 This is a universal application and can  
 be used in any vehicle needing a jamb  
 switch.  
 (Stock # V13-21040-010)  
**OEM # B-13713 each. . . . . 10.95**



**Door Jamb Switches**  
 1962-65 Fairlane  
 1966-67 Fairlane - front doors only  
 1966-67 Comet  
 NOTE: will work for dome light in some  
 applications  
 (Stock # M13-21040-005) (A)  
**OEM # 8M-13713 each . . . . . 8.95**  
 1965-67 Fairlane - stainless bezel  
 (Stock # P13-21040-015) (B)  
**OEM # C3AZ-13713-A each. . . . . 5.95**



**Door Jamb Switches**  
 1965-67 Fairlane - dome light in door  
 jamb  $\frac{3}{4}$ " diameter hole with white plastic  
 bezel  
 (Stock # P13-21040-016)  
**OEM # C5AZ-13713-A each. . . . . 4.95**



**Dome Light Assembly**  
 We have made a bright chrome base with  
 a brighter than original bulb to really im-  
 prove the lighting inside your car. Includes  
 instructions on how to add this to cars that  
 didn't include this feature. It can even be  
 mounted up under the back deck to make  
 a great trunk light. Our reproduction dome  
 lens and chrome bezel as well as the  
 mounting hardware and electrical connec-  
 tors are included to make this a quick and  
 simple project.  
 1962-64 Fairlane  
 (Stock # P13-21040-200)  
**OEM # COAF-13A719-B each . . . 43.95**



**Console Lamp Lens**  
 White plastic on rear of the console  
 1966-67 Fairlane - Hardtop or Convertible  
 (Stock # P13-21050-005)  
**OEM # C5ZZ-13734-A each . . . . . 4.95**



**Courtesy Lamp Bracket**  
 1966 Fairlane - Convertible  
 1968 Ranchero  
 (Stock # P61-66200-100)  
**OEM # COAZ-13763-A each. . . . . 10.95**



**Step Courtesy Light** New!  
 Features a milk tinted glass lens sur-  
 rounded by a one piece housing and  
 bezel sculpted in high grade polished  
 aluminum. 12 volt festoon style bulb and  
 mounting hardware included.  
 Large - 5 $\frac{5}{8}$ " x 2 $\frac{1}{2}$ "  
 (Stock # R13-21115-039)  
**OEM # HR-13771-LST each . . . . . 89.95**  
 Small - 3 $\frac{1}{16}$ " x 1 $\frac{5}{8}$ "  
 (Stock # R13-21115-069)  
**OME # HR-13771-SST each. . . . . 59.95**



**Dome Lamp Lens**  
 1962-65 Fairlane - round white plastic  
 (Stock # P13-21135-035) (A)  
**OEM # COAF-13783-C each . . . . . 3.95**  
 1964 Fairlane Station Wagon  
 (Stock # P13-21135-025) (B)  
**OEM # B8A-13783-A each. . . . . 9.95**

**Save on shipping by  
 watching for our Free  
 Freight e-mails. You can  
 join our e-mail club at  
[www.ClassicAutoParts.com](http://www.ClassicAutoParts.com)**

# 1962-72 Fairlane



(A)



(B)

### Dome Lamp Lens

1966-67 Ranchero

(Stock # X13-21135-040) (A) **Price Reduced!**

**OEM # C0DF-13783-B each . . . . . 7.95**

1965-71 Fairlane Station Wagon

(Stock # P13-21135-070) (B)

**OEM # C5AZ-13783-E each . . . . . 16.95**



(A)



(B)

### Dome Lamp Lens

1966-71 Fairlane and Torino/Comet and Montego

(Stock # B13-21135-075) (A)

**OEM # C6OZ-13783-A each . . . . . 7.95**

1972 Torino

(Stock # P13-21135-080) (B)

**OEM # D1AZ-13783-B each . . . . . 8.95**



### Chrome Horn Ring

Includes retainer and contact - no emblem  
1962-63 Fairlane

(Stock # X13-21200-065)

**OEM # C0DZ-13A805-A each . . 113.95**



### Chrome Horn Ring

3-spoke ring for the Woodgrain Wheel

1966-67 Fairlane

(Stock # B13-21200-090)

**OEM # C7OZ-13A805-E each . . . 39.95**

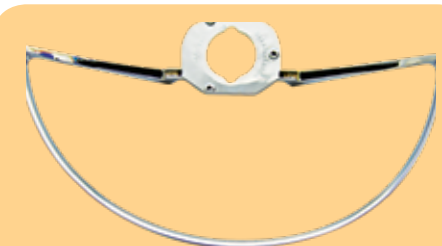

### Chrome Horn Ring

For the 3-spoke wheel without speed control

1968-69 Fairlane and Torino/Comet

(Stock # P13-21200-095)

**OEM # C9AZ-13A805-B each . . . 89.95**



### Horn Button Spring

1962-69 All - standard wheel

(Stock # X13-21210-015)

**OEM # C0DZ-13A807-B each . . . . 3.95**



### Horn Button/Ring Contact Plate

1965-66 Fairlane

(Stock # F13-21215)

**OEM # D1TZ-13A808-A each . . . . 9.95**



### Horn Ring Index Plate

Also called ring retainer

1962-64 Fairlane

(Stock # X13-21220-040)

**OEM # C2DZ-13A809-A each . . . . 2.95**



### Horn Ring Index Plate

1965-66 Fairlane - with alternator

(Stock # F13-21220-055)

**OEM # D1TZ-13A809-B each . . . . 2.95**



### Horn Blowing Cam Ring

1965-66 Fairlane

(Stock # P13-21230-005)

**OEM # C5AZ-13A811-A each . . . 27.95**



### Horn Blowing Ring Pad

Rubber pad under the button

1962-68 Fairlane - except Sports Coupe

1966 & 1968 Comet

(Stock # X13-21240)

**OEM # C0DZ-13A813-A each . . . . 3.95**



(A)

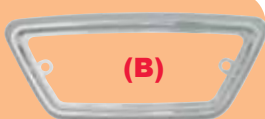

(B)

### Dome Light Bezel

Chrome plated - Perfect reproductions!

1962-65 Fairlane

(Stock # P13-21150) (A)

**OEM # C0AF-13788-A each . . . . . 7.95**

1966-67 Ranchero

(Stock # X13-21150-005) (B)

**OEM # C0DF-13788-A each . . . . . 6.95**



(A)



(B)

### Dome Light Bezel

Chrome plated

1966-71 Fairlane - before 6-1-71 (A)

(Stock # P13-21150-020)

**OEM # D0AZ-13788-A each . . . . 12.95**

1971-72 Torino - after 6-1-71

(Stock # P13-21150-025) (B)

**OEM # D1AZ-13788-A each . . . . 23.95**



### Dome Light Wire Socket

1962-64 Fairlane

(Stock # X13-21170-008)

**OEM # C0DF-13796-A each . . . . . 5.95**

**Call Us:**  
**1-800-654-3247**

# 1962-72 Fairlane

Lighting Parts



### Horn Ring Contact Brush

1962-64 Fairlane  
(Stock # B13-21260-010)  
**OEM # C2OZ-13A821-A each . . . . 3.95**



### Horn Switch Brush Plate

This is the inner plate  
1965-67 Fairlane - except woodgrain wheel  
1966 Comet  
(Stock # P13-21270-010)  
**OEM # C5AZ-13A823-F each . . . . 53.95**

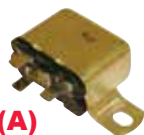

(A)



(B)

### Horn Relay and Bracket

1962-63 Fairlane  
1966 Comet  
(Stock # F13-21330-025) **(A)**  
**OEM # B8C-13853 each . . . . . 29.95**  
1964 Fairlane  
(Stock # P13-21330-035) **(B)**  
**OEM # C4AZ-13853-A each . . . . . 9.95**



### Horn Blowing Contact and Spring Lower Insulator

1965-69 Fairlane - except woodgrain wheel  
(Stock # P13-21345)  
**OEM # C5AZ-13867-A each . . . . . 7.95**



### Rim Horn Switch Gap Cover

Black plastic piece that fits into the groove on the bottom of the steering wheel.  
1970-74 Fairlane and Torino  
(Stock # P13-21340-115)  
**OEM # D1AZ-13875-C each . . . . . 12.95**

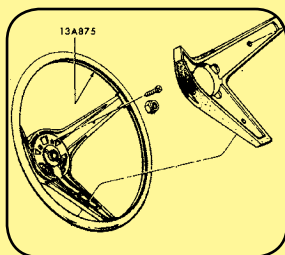

### Horn Blowing Switch Assembly

Use with three spoke wheel-rim blow type  
1969 Fairlane  
(Stock # P13-21350-005)  
**OEM # C9AZ-13A875-C each . . . . 99.95**



### Horn Blowing Switch Wire

1970-74 Fairlane and Torino - 3 spoke wheels  
(Stock # P13-21350-010)  
**OEM # D1AZ-13A875-A each . . 161.95**

### Horn Switch Assembly

For the 2-spoke wheels - fits Standard or Deluxe - 2 pressure switches with connection terminals installed into the black plastic holder.  
1970-74 Fairlane and Torino  
(Stock # P13-21350-015)  
**OEM # D2AZ-13A875-A each . . 109.95**

**It has been my observation that most people get ahead during the time that others waste.**

~ Henry Ford

**1-800-654-3247**

**Call Us for**

**All-American**

*Deals*



### Horn Index Insulator

Round felt washer type nylon insulator pad  
1967 Fairlane  
(Stock # P13-21370)  
**OEM # C7AZ-13A903-B each . . . . 1.95**

Standard Wheel



Deluxe Wheel



### Horn Bar Switch Covers

Black vinyl - for 2 spoke wheels  
1970-74 Torino - Standard wheel  
(Stock # P13-21390)  
**OEM # D3AZ-13A915-A each . . . 39.95**  
1970-74 Torino - Deluxe wheel  
(Stock # P13-21390-010)  
**OEM # D3AZ-13A915-L each . . . 32.95**

### Horn Bar Switch Cover Trim

Silver and wood grain - for 2 spoke wheel  
1971-74 Fairlane and Torino  
(Stock # P13-21400)  
**OEM # D3AZ-13A932-A each . . . 43.95**

**We accept these MAJOR credit cards.**



**Please allow 7-14 days for Special Orders!**

# 1962-72 Fairlane



## Wiring Retainer

Tube size - 1/4"

(Stock # P14-22070-010)

**OEM # C7AB-14A163-B each . . . . .25**



## Non-Metallic Wiring Loom

3/8" inner diameter x 15' roll

1962-70 Fairlane and Comet

(Stock # P14-22095)

**OEM # C1AZ-14A240-A each . . . 10.95**

3/16" inner diameter x 15' roll

1962-70 Fairlane and Comet

(Stock # P14-22095-005)

**OEM # C1AZ-14A240-B each . . . 10.95**

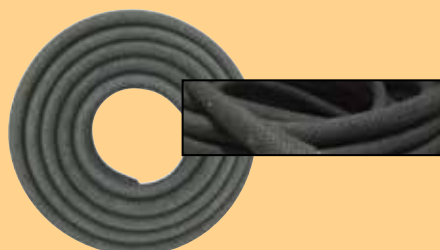

## Woven Wire Loom

Original style fabric type loom - protects wires from dirt, dust and corrosion. Holds several wires inside loom.

1962-70 Fairlane and Comet

(Stock # A14-22325-005) - 5/16" loom

**OEM # A-14407-K 30' roll . . . . . 14.95**

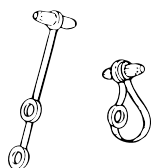

## Wire Harness Retaining Strap

1962-72 Fairlane and Comet

(Stock # PC3-76540-010)

**OEM # COAZ-376914-S each . . . . . .95**



## Dash to Engine Gauge Feed Wiring

1964-65 Fairlane - 8 cylinder

(Stock # B14-22115-006)

**OEM # C4OF-14289-C each . . . . . 39.95**

1966 Fairlane - small block

(Stock # B14-22115-010)

**OEM # C6OZ-14289-B each . . . . . 84.95**

1966 Fairlane - big block

(Stock # B14-22115-015)

**OEM # C6OZ-14289-C each . . . . . 53.95**

1967 Fairlane - small block

(Stock # B14-22115-020)

**OEM # C7OZ-14289-E each . . . . . 84.95**

1967 Fairlane - big block

(Stock # B14-22115-025)

**OEM # C7OZ-14289-F each . . . . . 44.95**



**Special ORDER**

## Dash to Headlight Junction Wiring Harness

1964 Fairlane - with generator

(Stock # B14-22120-048)

**OEM # C4OZ-14290-A each . . . 225.95**

1965 Fairlane - with alternator

(Stock # B14-22120-104)

**OEM # C5OZ-14290-A each . . . 229.95**

1966-67 Fairlane

(Stock # B14-22120-005)

**OEM # C6OZ-14290-E each . . . . . 0.00**



## Battery Disconnect Switch

Prevent fire and theft with this master disconnect switch. This is a great safety item and a must have for cars in storage. Instructions included.

(Stock # A14-22140-030)

**Price Reduced!**

**OEM # A-14300-D each . . . . . 37.95**



## Battery Cable Post and Nut Set

1962-72 Fairlane and Torino

1966-71 Comet and Montego

1/4" with special square head bolt

(Stock # P14-22140-115) - includes nut

**OEM # COAZ-14300-AMB pair . . . 2.95**

5/16" square head bolt

(Stock # P14-22140-120)

**OEM # COAZ-14300-BMB pair . . . 2.95**



## Engine Ground Wire

1962-64 Fairlane - 6 cylinder

(Stock # P14-22155-075)

**OEM # FEV-14303-A each . . . . . 7.95**



## Wiring Terminal

Snap on internal flag type

1962-72 All

(Stock # P14-22480-005)

**OEM # C1AF-14474-A each . . . . . 1.95**

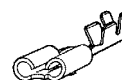

## Wiring Terminal

Snap on female

1962-72 All

(Stock # B14-22480-040)

**OEM # D2OZ-14474-F each . . . . . .95**



**Special ORDER**

## Alternator to Regulator Wiring

1965 Fairlane - 8 cylinder

(Stock # B14-22165-212)

**OEM # C5OZ-14305-D each . . . . 43.95**

1966-67 Fairlane - 8 cylinder

(Stock # B14-22165-080)

**OEM # C6OZ-14305-F each . . . . . 53.95**

1967-68 Fairlane - 390, 427, 428

(Stock # B14-22165-085)

**OEM # C7OZ-14305-J each . . . . . 79.95**

# 1962-72 Fairlane



### Main Body Harness

This hooks from the engine harness to the back of the car and thru-out the body.  
1965 Fairlane - 2 and 4 door  
(Stock # B14-22315-407)  
**OEM # C50Z-14405-B each. . . . 252.95**



### Male Wire Connectors

These are brass bullet ends that plug into the female wire connector.  
(Stock # V14-22500-020) - set of 10  
**OEM # B-14486-S set . . . . . 3.95**

### Female Wire Connectors

Single female end allows one male wire to plug in from each end. Show above with a bullet end installed.  
(Stock # V14-22505-010) - set of 10  
**OEM # B-14487-K set . . . . . 8.95**



### Female Wire Connector

Four way plug - two wires can plug into each end - accepts #14, 16, 18 gauge wire  
(Stock # P14-22505-015)  
**OEM # B6A-14487-A each. . . . . 2.95**



### Ignition Switch Wiring Connector

Copy with yellow vinyl coat.  
1968-72 All  
(Stock # P14-22505-040)  
**OEM # C9AZ-14487-D each. . . . . 13.95**

Friend us on Facebook and follow us on Twitter. You never know what you might be in for.



### Power Window Regulator Switch Plate

1963-64 Fairlane Station Wagon - tailgate control  
(Stock # P14-22565-005)  
**OEM # B7A-14523-A each. . . . . 9.95**



### Tailgate Control Electrical Circuit Breaker

1964-72 Fairlane Station Wagon - tailgate  
(Stock # C14-22580-010) - 20 amp  
**OEM # C4DZ-14526-B each. . . . . 17.95**



### Power Window Switch Housing

Single type - Chrome plated  
1963-64 Fairlane Station Wagon  
(Stock # P14-22590)  
**OEM # B5A-14528-B each. . . . . 29.95**



### Power Window Switch

Chrome knob - single type  
1972 Fairlane and Torino - right hand front door or either side rear door or quarter window  
(Stock # P14-22595-085)  
**OEM # D3AZ-14529-F each. . . . . 24.95**

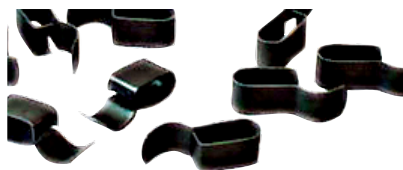

### Wiring Clip Set

Wiring to frame clips - has alligator style jaws that push onto frame and hold wiring. Sold in sets of 10 pieces.  
(Stock # V14-22680-010)  
**OEM # B-14585-K set . . . . . 5.95**

Please allow 7-14 days for Special Orders!

## Obsolete & Classic Auto Parts, Inc.

8701 South I-35  
Oklahoma City, OK 73149

### Summer Store Hours:

Monday - Friday  
8 a.m. thru 6 p.m.  
Saturday  
8 a.m. thru 12 p.m.

### Winter Store Hours:

Monday - Friday  
8 a.m. thru 5 p.m.  
Saturday  
8 a.m. thru 12 p.m.  
(Central Standard Time)

We accept VISA • DISCOVER  
MASTERCARD

check us out at  
[www.classicautoparts.com](http://www.classicautoparts.com)

NEXT DAY AIR  
service available  
on ALL orders!



Stop by our showroom!

# 1962-72 Fairlane



### Cigar Lighter Knobs

1962 Fairlane - early  
(Stock # X15-23055-060) - *white with chrome*  
**OEM # C0DB-15052-W each . . . . . 9.95**  
1962-64 Fairlane - latet  
(Stock # P15-23055-055) - *black with chrome*  
**OEM # C0AZ-15052-B each . . . . . 9.95**



### Cigar Lighter Element

1966-67 Comet  
(Stock # C15-23065)  
**OEM # C4DZ-15054-A each . . . . . 9.95**



### Cigar Lighter Socket and Retainer

1966-71 Fairlane (A)  
(Stock # P15-23070-010)  
**OEM # C4AZ-15055-B each . . . . . 6.95**  
1972 Torino  
(Stock # P15-23070-015)  
**OEM # D3AZ-15055-A each . . . . . 8.95**



### Fog Lamp Assembly

Front bumper or splash pan mount  
1962-72 All  
(Stock # P15-23110-020) - *clear lens*  
**OEM # C5RZ-15200-A each . . . . . 44.95**



### Dummy Spotlight

Teardrop shaped stainless steel housing, chrome zinc die cast arm with clear lens - 4 3/4" diameter x 5 1/2" deep  
(Stock # V15-23110-010)  
**OEM # B-15200-DMY each . . . . . 41.95**



### Accessory Fog Lamps

These are really nice. Complete with bracket, mounting bolts, amber lenses and switch. NOTE: Specify year and body style of car so we can supply the correct mounting brackets and template needed for installation.  
1962-72 Fairlane and Comet  
(Stock # P15-23110-015)  
**OEM # B6A-15200 set . . . . . 224.95**



### Body Side Rear Marker Lamp

1969 All  
(Stock # P15-23115)  
**OEM # C9AZ-15A201-C each . . . 11.95**



### Front Side Marker Lamp

Housing and lens - amber  
1970-71 Torino  
(Stock # B13-23115-020) - *either side*  
**OEM # D0OZ-15A201-AM each . 23.95**



### Rear Side Marker Lamp

Housing and lens - red  
1970 Torino  
(Stock # B13-23115-021) - *either side*  
**OEM # D0OZ-15A201-RD each . . 24.95**



### Side Marker Lamp to Body Gasket Set

1968 Comet  
(Stock # X15-23120-095)  
**OEM # C8GY-15A209-A pair . . . . . 4.95**  
1970 Fairlane and Torino  
(Stock # P15-23120-010) (A)  
**OEM # D0DZ-15A209-A set . . . . . 2.95**



### Marker Lamp

Front fender - clear lens  
1969 Fairlane Talladega  
(Stock # X15-23135) - *either side*  
**OEM # C9DZ-15A215-C each . . . 12.95**



### Fog Lamp Bulb

Amber lens #4415A  
(Stock # M15-23145-020)  
**OEM # FDU-15220-B each . . . . . 55.95**



# 1962-72 Fairlane

Accessory Parts



### Side Marker Lamp Socket and Wire

For front or rear side marker lamps  
1970-72 All  
(Stock # X15-23190)  
**OEM # D0DZ-15A434-B each . . . . 9.95**



### Marker Lamp Bezel

Chrome plated bezel for front or rear side marker lamps.  
1969 Fairlane/Talladega/Comet  
(Stock # P15-23195)  
**OEM # C9AZ-15A440-A each . . . 17.95**

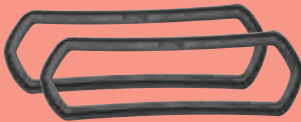

### Front Side Marker Lamp Housing Gaskets

1968 Fairlane and Torino/Comet Price Reduced!  
(Stock # B15-23215-200)  
**OEM # C8WY-15A447-A set . . . . 3.95**



### Side Marker Body Pads

Does front and rear marker lamps  
1969 Fairlane and Torino/Comet  
(Stock # P15-23215) Price Reduced!  
**OEM # C9AZ-15A447 set . . . . . 2.95**

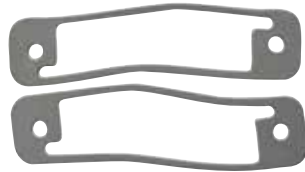

### Side Marker Light Gaskets

1972-76 Ranchero  
(Stock # B15-23215-025)  
**OEM # D2OZ-15A447-A pair . . . . . 4.95**

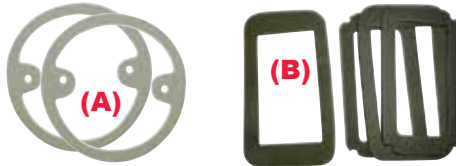

### Backup Light Lens Gaskets

1963 Meteor Station Wagon  
(Stock # X15-23245-026) (A)  
**OEM # C0DB-15510-A pair . . . . . 2.95**  
1965 Fairlane  
(Stock # B15-23245-060) (B)  
**OEM # C5OZ-15510-S set . . . . . 7.95**

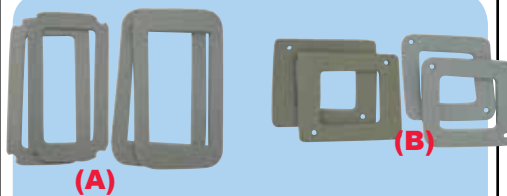

### Backup Light Lens Gaskets

1966 Fairlane Station Wagon  
(Stock # B15-23245-070)  
**OEM # C6OZ-15510-D set . . . . . 7.95**  
1966 Fairlane - except Station Wagon  
(Stock # B15-23245-075) (A)  
**OEM # C6OZ-15510-S set . . . . . 7.95**  
1967 Fairlane - except Station Wagon and Ranchero  
(Stock # B15-23245-085)  
**OEM # C7OZ-15510 set . . . . . 9.95**  
1967 Fairlane Station Wagon and Ranchero  
(Stock # B15-23245-090) (B)  
**OEM # C7OZ-15510-B set . . . . . 9.95**

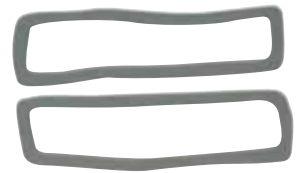

### Backup Light Gaskets

1968-69 Fairlane Station Wagon  
(Stock # B15-23245-100)  
**OEM # C8OZ-15510-B set . . . . . 8.95**



### Accessory Engine Compartment Lamp Kit

Complete unit that has a mercury switch built in. This will also work great in your trunk area if light is needed.  
1962-72 All  
(Stock # P15-23350)  
**OEM # C2RZ-15A700-A each . . . 17.95**



### Shifter Lamp Wire

1965 Fairlane  
(Stock # B15-23377-055) - 73" long  
**OEM # C5OB-15A808-A each . . . 35.95**

**Please allow 7-14 days for Special Orders!**

**Check out our Swap Meet Schedule to see when we will be close. Maybe even save some on shipping. Call one of the guys for more information!**



# 1962-72 Fairlane

Fenders & Hoods



### Fiberglass Front Fenders

Superb quality fenders made to exacting specifications. This fender has the '64 trim indentions. These Drop Ship directly to your door.

Allow 2-4 weeks on delivery. NOTE: Oversized Freight Applies 1963-64 Fairlane

- (Stock # B16-24020-215) - right hand
- OEM # C3OZ-16005-FG each. . . . . 389.95**
- (Stock # B16-24025-220) - left hand
- OEM # C3OZ-16006-FG each. . . . . 389.95**



### Fiberglass Front Fenders

Superb quality fenders made to exacting specifications. These Drop Ship directly to your door. Allow 2-4 weeks on delivery.

- NOTE: Oversized Freight Applies
- 1966-67 Fairlane
- (Stock # B16-24020-225) - right hand
  - OEM # C6OZ-16005-FG each. . . . . 389.95**
  - (Stock # B16-24025-230) - left hand
  - OEM # C6OZ-16006-FG each. . . . . 309.95**
- 1967 Ranchero
- (Stock # B16-24020-230) - right hand
  - OEM # C7OZ-16005-FG each. . . . . 389.95**
  - (Stock # B16-24025-240) - left hand
  - OEM # C7OZ-16006-FG each. . . . . 389.95**

**FENDERS ARE OVERSIZED AND SHIPPED VIA MOTOR FREIGHT TRUCK SHIPPING. OVERSIZED CHARGES WILL APPLY.**

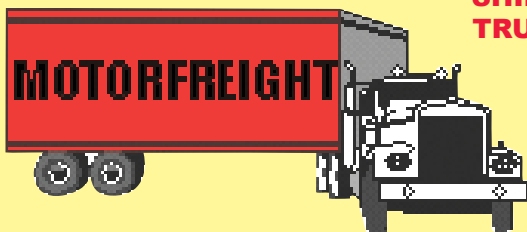

### Front Fender Patch Panels

Die stamped steel lower rear of the front fender. Sold per side.

- 1966-67 Fairlane/Ranchero - 12" high (A)
- (Stock # B16-24020-028) - right hand
- OEM # C6OZ-16005-LR each . . . 139.95**
- (Stock # B16-24025-233) - left hand
- OEM # C6OZ-16006-LR each . . . 139.95**
- 1970-71 Fairlane and Torino/Ranchero - 20" tall
- (Stock # D16-24020-062) - right hand
- OEM # D0OZ-16005-LRR each . . 84.95**
- (Stock # B16-24025-273) - left hand
- OEM # D0OZ-16006-LRL each . . . 84.95**



### Fender Extension Moldings

Used on the front edge of the front fenders. Made of die stamped steel to exact of original. Plated in the original bright anodized finish. Includes mounting hardware.

- 1966-67 Fairlane
- 1967 Ranchero
- (Stock # B16-24050)
- OEM # C6OZ-16D014/5-A pair . . 34.95**



### Inner Fender Apron

Die stamped steel - fits below and around your battery.

- 1966-69 Fairlane and Torino
- 1967-69 Ranchero
- (Stock # ZB16-24155-012)
- OEM # C6OZ-16054-A each. . . . 119.95**

**Check out our website for information, and to check on current prices!**

# 1962-72 Fairlane

Fenders & Hoods

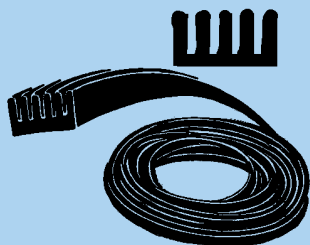

### Anti-squeak Webbing

Used on front bumper stone deflector, front fender apron splash panel, cowl side panel to fender filler, front fender apron splash panel, clutch shield to frame, cowl side panel to fender, plus many applications not listed.

1962-72 Fairlane and Comet - all  
(Stock # M16-24205-050)

**OEM # 8M-16070-K 15' roll . . . . 14.95**



### Fender and Side Molding Clip

1968-72 Fairlane and Torino  
(Stock # M16-24220-035)

**OEM # C8GY-16A076-A each . . . . 2.95**



### Wheel Molding Screw Kit

1967-72 Fairlane

(Stock # P16-24125-005) - set of 20

**OEM # C7AZ-16038-MB each . . . . 3.95**



**Our standard ground service is shipped by FedEx. If you desire another carrier, let us know when you place your order, and we'll get you the details.**



### Front Wheel Lip Moldings

Anodized Aluminum - sold per side

**1966 Fairlane - all body styles**

(Stock # B16-24125) - right hand

**OEM # C6OZ-16038-A each. . . . 39.95**

(Stock # B16-24130) - left hand

**OEM # C6OZ-16039-A each. . . . 39.95**

**1967 Fairlane - all body styles**

(Stock # B16-24125-010) - right hand

**OEM # C7OZ-16038-A each. . . . 39.95**

(Stock # B16-24130-005) - left hand

**OEM # C7OZ-16039-A each. . . . 39.95**

**1968-69 Fairlane and Torino - all body styles**

(Stock # B16-24125-020) - right hand

**OEM # C9OZ-16038-A each. . . . 39.95**

(Stock # B16-24130-015) - left hand

**OEM # C9OZ-16039-A each. . . . 39.95**

**1970-71 Fairlane and Torino - except GT**

(Stock # B16-24125-030) - right hand

**OEM # D0OZ-16038-C each . . . . 39.95**

(Stock # B16-24130-025) - left hand

**OEM # D0OZ-16039-C each . . . . 39.95**

### Rear Wheel Lip Moldings

Anodized Aluminum as original - per side

**1966 Fairlane**

(Stock # B29-49145-005) - right hand

**OEM # C6OZ-29164-62A each . . 39.95**

(Stock # B29-49150-005) - left hand

**OEM # C6OZ-29165-62A each . . 39.95**

**1967 Fairlane**

(Stock # B29-49145-020) - right hand

**OEM # C7OZ-29164-62A each . . 39.95**

(Stock # B29-49150-020) - left hand

**OEM # C7OZ-29165-62A each . . 39.95**

**1968-69 Fairlane and Torino**

(Stock # B29-49145-030) - right hand

**OEM # C9OZ-29164-54B each. . . 39.95**

(Stock # B29-49150-030) - left hand

**OEM # C9OZ-29165-54B each. . . 39.95**

**1970-71 Fairlane and Torino - except GT**

(Stock # B29-49145-040) - right hand

**OEM # D0OZ-29164-65A each . . 39.95**

(Stock # B29-49150-040) - left hand

**OEM # D0OZ-29165-65A each . . 39.95**

**1970-71 Fairlane and Torino - GT**

(Stock # B29-49145-045) - right hand

**OEM # D0OZ-29164-65B each . . 39.95**

(Stock # B29-49150-045) - left hand

**OEM # D0OZ-29165-65B each . . 39.95**



### Front Fender Emblem

Chrome plated script - fits either side  
1964 Fairlane

(Stock # B16-24260-070)

**OEM # C4OZ-16098-A each. . . . 139.95**



### Front Fender Emblem

Chrome plated script with black painted  
recessed letters as original. Adhesive

1966-67 Ranchero

(Stock # X16-24260-105)

**OEM # C6DZ-16098-C each. . . . 26.95**



### GTA Crown Emblem

Exact reproduction with factory colors.  
Replace that old faded emblem today!

1966 Fairlane GTA

(Stock # B16-24260-115)

**OEM # C6OZ-16098-A each. . . . 39.95**



### GT Fender Badge

Injected molded plastic reproduction of  
original GTA and GT fender emblems.  
Chrome plated plastic.

1966 Fairlane GT

(Stock # B16-24260-120)

**OEM # C6OZ-16098-B each. . . . 12.95**

**We accept these MAJOR credit cards.**



# 1962-72 Fairlane



## Cyclone Emblem Inserts

We have an exact reproduction of the original fender inserts used on 1964/1966 Mercury® Cyclones. Manufactured of embossed aluminum and designed to replace the original faded insert on your vehicle.

1966 Cyclone

(Stock # X16-24260-139)

**OEM # C7GY-16098-A pair . . . . 71.95**



## GTA Fender Emblems

These are triple chrome plated with correct stamped aluminum GTA color keyed insert. Not a reproduction, but the original Ford® part correct with Ford® markings on backside of emblem. Made in the original Ford® molds right here in the USA!

1967 Fairlane GTA

(Stock # B16-24260-145)

**Price Reduced!**

**OEM # C7OZ-16098-A pair . . . . 45.95**

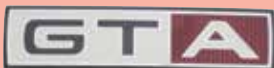

## GTA Fender Emblem Insert

These are adhesive inserts that go into your GTA Fender emblem replacing only the colored section.

1967 Fairlane GTA

(Stock # B16-24260-155)

**OEM # C7OZ-16098-MI each . . . 11.95**



## Front Fender and Rear 1/4 Panel Letters

Chrome plated with black centers. Barrel clips included for installation.

1967 Fairlane

1970 Fairlane, Torino and Ranchero

1970-73 Montego

'G' - (Stock # P16-24260-165)

**OEM # C7ZZ-16098-A each . . . . 29.95**

'T' - (Stock # P16-24260-170)

**OEM # C7ZZ-16098-B each . . . . 29.95**



## GT Front Fender Emblem

Stamped aluminum painted and anodized. Fits either side.

1967 Comet GT

(Stock # M16-24260-140)

**OEM # C7GY-16098-B each. . . . 27.95**



## Front Fender Script

Chrome plated - barrel clips included

1970-76 Ranchero - 500 and Squire

(Stock # B16-24260-180)

**OEM # D0OZ-16098-F each. . . . 85.95**



## Fender and Rear 1/4 Emblem

Chrome plated adhesive emblem

1970-76 Ranchero

(Stock # B16-24260-185)

**OEM # D0OZ-16098-H each . . . . 18.95**



## 500 Emblem

This is the emblem that follows Ranchero script on 500 models from 1970/1976.

This emblem can also be used on quarter panel of 68/69 Fairlane 500. Adhesive backed.

(Stock # B16-24260-190)

**OEM # D0OZ-16098-J each . . . . 32.95**



## Front Fender and Tailgate Script

Reproductions of the original gran Torino sport emblem used on 1972/1975 Torino. All emblems include barrel clips and are painted as original.

1972-75 Torino

(Stock # B16-24260-200)

**OEM # D2OZ-16098-DEF set . . . 109.95**



## Upper Rear Fender to Cowl Seal

1966-67 Fairlane

(Stock # B16-24275-030)

**OEM # C6OZ-16102/3 pair . . . . 17.95**

1968-69 Torino - includes hardware

(Stock # B16-24275-200)

**OEM # C8OZ-16102/3 pair . . . . 34.95**



## Front Fender Extensions Seals

Also used for the rear quarter panel extension seals.

1965-71 Fairlane and Torino

(Stock # M16-264320)

**OEM # D0MZ-16D130-A pair . . . . 3.95**



## Fender Extension Seals

Seals your fender to the bumper area.

1968-69 Torino and Ranchero

(Stock # B16-24320-100)

**OEM # C8OZ-16134/5-A pair . . . 11.95**



## Fender Extension Seals

Seals your fender to the bumper area.

1970-71 Torino and Ranchero

(Stock # B16-24320-200)

**Price Reduced!**

**OEM # D0OZ-16134/5-A pair . . . 12.95**

**Obsolete & Classic Auto Parts, Inc.**

# 1962-72 Fairlane

Fenders & Hoods



### Radiator Core Support

Die stamped steel and EDP coated. Modifications will be needed for Convertible applications. Super nice piece, ready to install.

1970-71 Torino

(Stock # P10-24330-030)

**OEM # D3ZZ-16138-A each. . . . . 159.95**



### Front Fender Ornaments

We have an excellent quality American made reproduction of the original fender ornaments mounted on the fender tops. Triple chrome plated to perfection!

1964 Fairlane

(Stock # B16-24405-095) - 10 1/2" long

**OEM # C4OZ-16178/9-A pair . . 289.95**



### Front Fender Emblem

Beautiful chrome plating accented with red painted numbers. Fits either side.

1962-63 Fairlane

(Stock # B16-24450-040)

**OEM # C2OZ-16228-B each. . . . . 15.95**



### Front Fender Emblem

Chrome plated with black detail. Fits either side - complete with barrel nuts.

1963-64 Fairlane

(Stock # B16-24450-100)

**OEM # C3OZ-16228-B each. . . . . 9.95**



While Supply Lasts

### 427 Bird Emblem

This is a die stamped steel piece that has all the correct colors. The fit on the front fenders and/or the oval air cleaner. Superb quality at a great price!

1964 Fairlane

(Stock # P16-2445-065) - gold, black and white

**OEM # C3AZ-16228-D each. . . . . 39.95**

Price Reduced!



### Front Fender Emblem

Chrome plated with correct black & red detail

1962-63 Fairlane

(Stock # C16-24450-110)

**OEM # C4DZ-16228-B each. . . . . 19.95**



### Front Fender Emblem

Chrome plated with black detail. Fits either side - complete with barrel nuts.

1963-65 Fairlane

(Stock # B16-24450-100)

**OEM # C4DZ-16228-C each. . . . . 9.95**

### Front Fender Emblems

These emblems were made because of customer demand. They are the bird style emblems but have all the different engine numbers on them. They will fit anywhere you want to put them. They are metal and superb quality. They are stamped metal in black, white, and gold. Discontinued when stock is depleted!



### 289

(Stock # P16-24450-075)

**OEM # C3AZ-16228-JJ each. . . . . 39.95**



### 302

(Stock # P16-24450-080)

**OEM # C3AZ-16228-KK each. . . . . 39.95**



### 351

(Stock # P16-24450-085)

**OEM # C3AZ-16228-LL each . . . . . 39.95**



### 428

(Stock # P16-24450-070)

**OEM # C3AZ-16228-E428 each . . 39.95**



### 429

(Stock # P16-24450-055)

**OEM # C3AZ-16228-429 each . . . 39.95**



### 460

(Stock # P16-24450-060)

**OEM # C3AZ-16228-460 each . . . 39.95**



We have tried to make ordering easy. You can order online with a click of the mouse, or use the order sheets in the back of the catalog. Simply mail or fax over. We'll handle it all from there.

# 1962-72 Fairlane



### 390 Bird Emblem

Red, black and chrome.  
(Stock # P16-24450-035)

**OEM # C2AZ-16228-RBW each . . 36.95**



### 390 Bird Emblem

Black and chrome.  
(Stock # P16-24450-062)

**OEM # C3AZ-16228-A each. . . . . 49.95**



### Front Fender Emblem

Cross flags with "289" In the center. Reproduction fender emblem used on 1966 Ranchero and 1965/1966 Fairlane models. Made in the USA. 1965-66 Fairlane

1966 Ranchero  
(Stock # B16-24450-145)

**OEM # C5OZ-16228-A each. . . . . 52.95**

**Price Reduced!**



### Fender Emblem Backing Plate

Chrome plated High Performance emblem that fits behind the 260 & 289 emblems on the previous page. Beautiful chrome plating with high quality black detail. Either side.

1963-65 Fairlane  
(Stock # P16-24450-150)

**OEM # C5ZZ-16228-B each . . . . . 9.95**

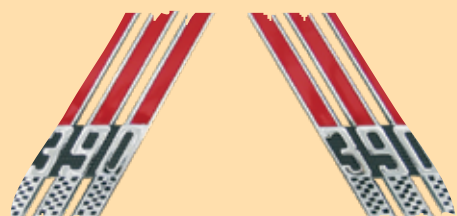

### Front Fender Emblems

Die stamped with superb chrome plating and high quality black and red inner detail. 1966-67 Fairlane

(Stock # P16-24450-245)

**OEM # C6AZ-16228/9-BE pair . . 69.95**



### Front Fender Emblems

Die stamped with superb chrome plating and high quality black and red inner detail. 1966-67 Fairlane

(Stock # P16-24450-250)

**OEM # C6AZ-16228/9-FC pair. . . 69.95**



### Front Fender Emblems

Die stamped with superb chrome plating and high quality black and blue inner detail.

1966 Fairlane

(Stock # P16-24450-255)

**OEM # C6AZ-16228/9-HE pair . . 69.95**



### Front Fender Emblem

Correct reproduction of the original 1966 fender emblems used on Fairlanes equipped with 390 engines. Made in the USA!

1966 Fairlane

(Stock # B16-24450-155)

**OEM # C6OZ-16228-A each. . . . . 58.95**



### Front Fender Emblems

Die stamped with superb chrome plating and high quality black and tri-color red/orange inner detail.

1967 Fairlane

(Stock # P16-24450-260)

**OEM # C7AZ-16228/9-B pair . . 69.95**



### Front Fender Emblems

Each emblem features original paint scheme and authentic detail. Beautiful chrome over ever inch of these emblems. Complete with barrel clips for installation. Fits: 1967-69 Fairlane/Comet

### 289

(Stock # B16-24450-170)

**OEM # C8OZ-16228-C each. . . . . 82.95**

### 302

(Stock # B16-24450-165)

**OEM # C8OZ-16228-B each. . . . . 17.95**

### 351

(Stock # M16-24450-180)

**OEM # C9GY-16228-A each. . . . . 35.95**

### 390

(Stock # B16-24450-175)

**OEM # C8OZ-16228-D each . . . 114.95**



### Cobra Snake Emblem

Concave adhesive emblem used on the front fenders and/or trunk area. Chrome plated.

1969 Torino

(Stock # B16-24450-195)

**OEM # C9OZ-16228-A each. . . . . 29.95**

**Price Reduced!**

**1-800-654-3247**

**Call Us for**

**All-American**

*Deals*

**Fenders & Hoods**

# 1962-72 Fairlane



## Front Fender Emblems

Zinc die cast as original, triple chrome plated and polished to a high gloss. Black detail as original.

- 1970 Torino  
(Stock # B16-24450-200) - 351 **Price Reduced!**
- OEM # D00Z-16228-B each . . . . 47.95**  
(Stock # B16-24450-205) - 429 **Price Reduced!**
- OEM # D00Z-16228-C each . . . . 75.00**



## Fender and Rear 1/4 Emblem

Chrome plated adhesive emblem  
1970-76 Rancho  
(Stock # B16-24260-185)

- OEM # D00Z-16098-H each . . . . 18.95**

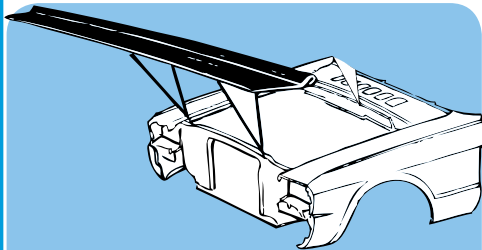

## Front Radiator Support to Hood Weatherstrip Seal

1964-65 Fairlane - with AC  
(Stock # B-16-24465-015)

- OEM # C40Z-16238-A each. . . . . 13.95**

1966-67 Fairlane and Comet  
(Stock # B16-24465-050)

- OEM # C60Z-16A238-A each . . . 11.95**

1969 Torino - 428

(Stock # B16-24465-020)

- OEM # C90Z-16238-A each. . . . . 23.95**

**1-800-654-3247**  
**Call Us for**  
**All-American**  
**Deals**



## Fender to Frame Seals

Located between the fender and the frame. These seal around the shock tower and keep debris from entering the engine compartment

1972-79 Torino and Rancho

(Stock # B16-24470-067)

- OEM # D20Z-16240-BC pair . . . . 17.95**



## Flag Fender Emblems

Chrome plated with black detail. Sold individually per side.

1966 Comet

(Stock # X16-24485-100) - right hand

- OEM # C6GY-16300-B each. . . . . 79.95**

(Stock # X16-24485-200) - left hand

- OEM # C6GY-16301-B each. . . . . 79.95**



## Glove Box Door Bumpers

1962-65 Fairlane - also used as the gas tank filler lid bumpers

(Stock # P16-24565)

- OEM # 0A-16378 pair . . . . . 2.95**

**We**  
**accept**  
**these**  
**MAJOR**  
**credit**  
**cards.**

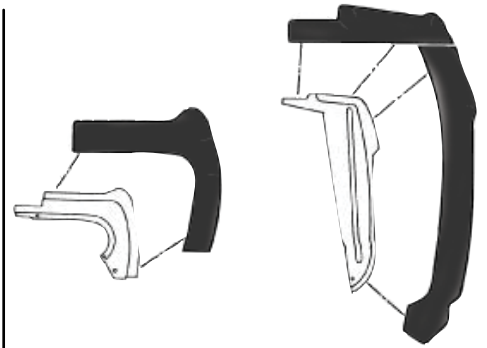

## Front Fender Splash Shields

Fits between the core support and the front fender at the front of the fender.

Helps to keep the road grime out of the headlight bucket area. Does both sides

1962-65 Fairlane

(Stock # B16-24695-003)

- OEM # C20Z-16A572-A pair . . . . 25.95**

1966-67 Fairlane and Rancho

(Stock # B16-24695-020)

- OEM # C60Z-16A572-A pair . . . . 17.95**

1966-67 Comet

(Stock # B16-24695-021)

- OEM # C60Z-16A572-B pair . . . . 22.95**

1968-69 Fairlane and Rancho

(Stock # B16-24695-025)

- OEM # C80Z-16A572-A pair . . . . 26.95**

1970-71 Torino

(Stock # B16-24695-101)

- OEM # D00Z-16A572-A pair . . . . 19.95**

1972 Torino and Rancho

(Stock # B16-24695-196)

- OEM # D20Z-16A572-A pair . . . . 19.95**

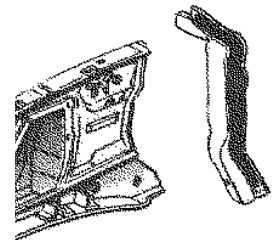

## Cowl Side Panel Seals

Rear of front fender to cowl side panel seals

1962-64 Fairlane

(Stock # B16-24700-005)

- OEM # C20Z-16A582-A pair . . . . 17.95**

1966-67 Fairlane

(Stock # B16-24700)

- OEM # C60Z-16A582/3 pair . . . . 19.95**



IF YOU HAVE ANY QUESTIONS JUST GIVE US A RING!

# 1962-72 Fairlane

COMET

## Comet Chrome Plated Emblem

This emblem was used on the hood of all Comets except the Cyclone and Cyclone GT. On the GT it was also used in the grill and on the trunk lid. American made!

1966 Comet

(Stock # X16-24710-009)

**OEM # C6GY-16604-A each. . . . 71.95**

Mercury

## Mercury® Hood Script

1967 Comet

(Stock # M16-24710-010)

**OEM # C7MY-16604-A each . . . . 89.95**

FORD

## F-O-R-D® Hood Letter Set

Chrome plated

1962-63 Fairlane - hood

(Stock # X16-24720-055)

**OEM # C2DZ-16606-AD set. . . . . 29.95**

## F-O-R-D® Hood and Trunk Letters

Chrome plated - this is one set of four letters

1965-67 Fairlane - hood or trunk

1966 Ranchero - tailgate

(Stock # P16-24720-100)

**OEM # C5AZ-16606-EFGH set 4 . 26.95**

## F-O-R-D® Hood and Trunk Letters

1968-69 Fairlane - trunk lid or Station Wagon tailgate

1968-73 Torino - hood

(Stock # P16-24720-125)

**OEM # C7AZ-16606-ABCD set. . . 13.95**

**I cannot discover that anyone knows enough to say definitely what is and what is not possible.**

**~Henry Ford**

F O R D

## F-O-R-D Letters

1968-69 Fairlane and Torino - hood, trunk or tailgate

(Stock # B16-24720-155)

**OEM # C8OZ-16606-AD set. . . . . 31.95**

F O R D

## F-O-R-D Letters

Chrome plated

1971 Ranchero - tailgate letters

(Stock # F16-24720-180)

**OEM # D0TZ-16606-K set . . . . . 74.95**



## Stock Fiberglass Hood

Stock flat style without teardrop bubble. USA Made to order. Allow 2-4 weeks for delivery. These are drop shipped Motor freight to your door. Oversized Freight Applies.

1963-64 Fairlane

(Stock # B16-24750-055)

**OEM # C3OZ-16612-FGSP0 each . . . . . 595.00**

1966-67 Fairlane

(Stock # B16-24750-151)

**OEM # C6OZ-16612-FGSP0 each . . . . . 539.95**



## Teardrop Fiberglass Hood

Teardrop style - specify 4" or 5" teardrop bubble These are drop shipped Motor freight to your door. Oversized Freight Applies. Allow 2-4 weeks for delivery.

1963-64 Fairlane - Thunderbolt style

(Stock # B16-24750-100)

**OEM # C4OZ-16612-TDXSPO each . . . . . 539.95**

1965 Fairlane

(Stock # B16-24750-132)

**OEM # C5OZ-16612-TDSPO each . . . . . 539.95**

1966-67 Fairlane

(Stock # B16-24750-152)

**OEM # C6OZ-16612-TDSPO each . . . . . 539.95**



Fenders & Hoods

# 1962-72 Fairlane

Fenders & Hoods



**Fiberglass Hood with Ram Air Scoops**  
 These are drop shipped Motor freight to your door. Oversized Freight Applies. Allow 2-4 weeks for delivery.  
 1966-67 Fairlane  
 (Stock # B16-24750-150)  
**OEM # C6OZ-16612-AFXSPO each . . . . . 539.95**  
 1966-67 Comet  
 (Stock # X16-24750-149)  
**OEM # C6GY-16612-FGSP0 each . . . . . 539.95**  
 1968-69 Fairlane and Torino  
 (Stock # B16-24750-162)  
**OEM # C8OZ-16612-RASPO each . . . . . 539.95**

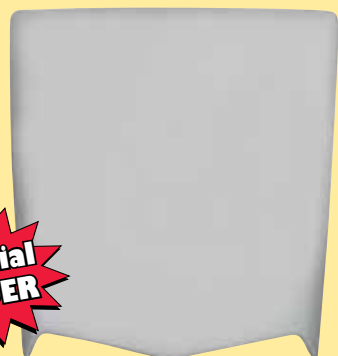

**Fiberglass Hood Scoop**  
 Original bolt-on style  
 1968-69 Cyclone  
 1971 Comet  
 (Stock # X16-24780-015)  
**OEM # D1DZ-16630-FGSP0 each . 131.95**

Price Reduced!



**Fiberglass Hood**  
 These are drop shipped Motor freight to your door. Oversized Freight Applies. Allow 2-4 weeks for delivery.  
 1967 Ranchero - Flat, Teardrop or Ram Air - please specify  
 (Stock # B16-24750-156)  
**OEM # C7OZ-16612-FGSP0 each . . . . . 595.00**



**Hood Scoop Emblem**  
 Exact reproduction hood scoop emblems and the metal insert for replacement on your hood scoop insert. Manufactured in the original stamped aluminum with black background. Complete emblem features triple chrome plating.  
 1968-69 Fairlane and Torino  
 (Stock # P16-24795-055) - 427  
**OEM # C9ZZ-16637-A each . . . . . 29.95**  
 (Stock # P16-24795-065) - 428  
**OEM # C9ZZ-16637-B each . . . . . 29.95**  
 (Stock # P16-24795-075) - 351  
**OEM # C9ZZ-16637-C each . . . . . 29.95**  
 (Stock # P16-24795-085) - 390  
**OEM # C9ZZ-16637-D each . . . . . 29.95**

**Hood Scoop Emblem Insert**  
 These have an adhesive back for easy replacement in your original chrome bezel.  
 1968-69 Fairlane and Torino  
 (Stock # P16-24795-060) - 427  
**OEM # C9ZZ-16637-A1 each . . . . . 17.95**  
 (Stock # P16-24795-070) - 428  
**OEM # C9ZZ-16637-B1 each . . . . . 7.95**  
 (Stock # P16-24795-080) - 351  
**OEM # C9ZZ-16637-C1 each . . . . . 6.95**  
 (Stock # P16-24795-090) - 390  
**OEM # C9ZZ-16637-D1 each . . . . . 6.95**

**Hood Prop Rod**  
 Specify year and body style when ordering - sold per application.  
 1966-71 Fairlane  
 1966-71 Comet  
 (Stock # P16-24780-001)  
**OEM # C0AZ-16630-PR kit . . . . . 49.95**



**Fiberglass Teardrop Hood Bubble - 35" x 45"**  
 1963-64 Fairlane  
 (Stock # P16-24780-005)  
**OEM # C4AZ-16630-FGSP0 each . 189.95**

**Please allow 7-14 days for Special Orders!**

# 1962-72 Fairlane



## Hood Scoop Seal

This is the gasket that seals the opening on the hood scoop. This is NOT used with a functional air scoop.

1969 Torino and Ranchero  
(Stock # P16-24815)

**OEM # C9ZZ-16C666-A each . . . . 12.95**

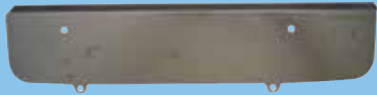

## Hood Scoop Back Plates

Mounts behind the scoop grill and functions to eliminate debris and keep water from entering. 12<sup>3</sup>/<sub>8</sub>" x 2<sup>1</sup>/<sub>2</sub>"

1972 Torino and Ranchero GT  
(Stock # B16-24815-050)

**OEM # D2OZ-16C666/7-A each . 17.95**



## Hood Seal Retainer Clips

Painted black with 2 clips and 4 screws  
1962 Fairlane  
(Stock # P16-24820)

**OEM # C5ZZ-16A670-A kit . . . . . 8.95**



## Hood Pin Brackets

To attach hood pins to the hood - as original. Front and back sold in sets only.  
1966-67 Fairlane and Cyclone  
(Stock # B16-24835-017)

**OEM # C6OZ-16700-AK set . . . . . 99.95**

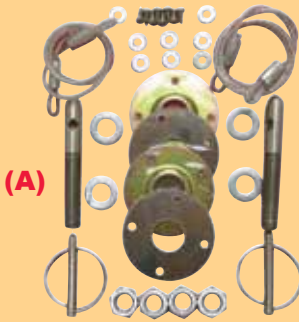

## Hood Pin Kit

With cables - Hood pins are recommended on all fiberglass hoods

1962-67 Fairlane  
(Stock # B16-24835-020)

**OEM # C7OZ-16700-AK set . . . . . 49.95**

Complete kit

1969 Fairlane and Comet  
(Stock # B16-24835-025)

**OEM # C9OZ-16700-C set . . . . . 119.95**



## Hood Auxiliary Latch Retainer

This is the retainer under the hood for the twist latch.

1970 Torino - Fastback  
(Stock # P16-24840)

**OEM # D0ZZ-16C712-A each . . . . . 9.95**



## Power Dome Hood Scoop Numbers

These numbers replace the original power dome hood scoop numbers. Die cast as original and painted in factory red paint scheme as original. Set of three.

1967 Fairlane  
(Stock # B16-24865-515) - 289

**OEM # C7OZ-16A720-BH set. . . 104.95**

(Stock # B16-24865-650) - 390

**OEM # C7OZ-16A720-ABC set. . . 89.95**



## Front Fender Emblem

This nameplate can be used as an accessory for any performance Ford. Originally used on the 1969 Fairlane Cobra but is a popular add on for high performance cars. Triple chrome plated and made in the USA!

1969 Torino  
(Stock # B16-24865-065)

**OEM # C9OZ-16720-A each . . . . . 45.95**



## Hood Scoop Emblem

Original hood scoop emblem for 1969/1971 Cobra jet vehicles. Used on ram air units in 1970/1971. Die cast and chrome plated to perfection.

1969-71 Torino  
(Stock # P16-24865-070)

**OEM # C9ZZ-16720-A each . . . . . 19.95**



## Hood Script

This is the small hood script located on the drivers side front of hood.

1970 Torino  
(Stock # B16-24865-075)

**OEM # D0OZ-16720-A each . . . . . 35.95**

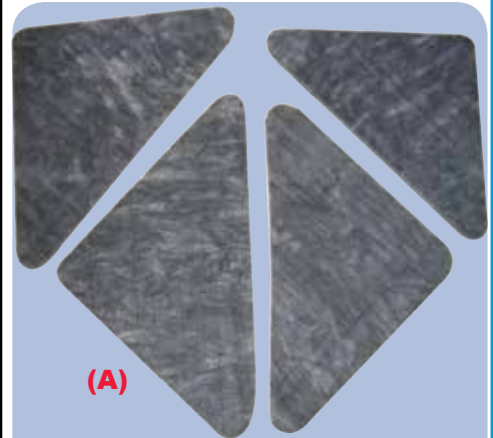

## Hood Insulation Kit

Fits on underside of hood.

1962-63 Fairlane  
(Stock # B16-24910-035)

**OEM # C3OZ-16738-A kit . . . . . 43.95**

1966-67 Fairlane & Comet  
(Stock # B16-24910-050)

**OEM # C6OZ-16738-A kit . . . . . 29.95**

1968-69 Fairlane and Torino  
(Stock # B16-24910-057)

**OEM # C8OZ-16738-A set . . . . . 34.95**



## Hood Insulation Clip

**Metal - 2" x 2"**

1962-72 Fairlane and Torino  
(Stock # P16-24990-100)

**OEM # C0AZ-16776-A each . . . . . 0.95**

**Plastic - 1.5" x 1.5"**

1966-68 Fairlane and Comet  
(Stock # M16-24990)

**OEM # C6GY-16776-A pkg of 5 . . . 5.95**

# 1962-72 Fairlane

Fenders & Hoods

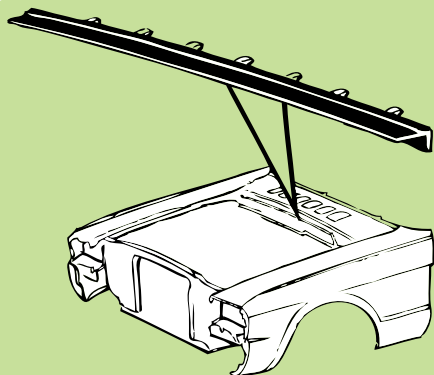

## Hood to Cowl Weatherstrip

Includes mounting clips

1962 Fairlane

(Stock # X16-24920-125)

**OEM # C2DZ-16740-A each. . . . . 6.95**

1963-64 Fairlane

(Stock # B16-24920-145)

**OEM # C3OZ-16740-A each. . . . . 17.95**

1965 Fairlane

(Stock # B16-24920-160)

**OEM # C5OZ-16740-A each. . . . . 18.95**

1966-67 Fairlane/Comet

(Stock # B16-24920-165)

**OEM # C6OZ-16740-A each. . . . . 12.95**

1968-69 Fairlane and Torino/Comet

(Stock # B16-24920-185)

**OEM # C8OZ-16740-B each. . . . . 21.95**

1970-71 Fairlane and Torino/Comet -

does NOT include fasteners

(Stock # B16-24920-200)

**OEM # D0OZ-16740-A each . . . . . 21.95**

1973-79 Fairlane and Torino

(Stock # B16-24920-215)

**OEM # D4OZ-16740-A each . . . . . 25.95**



## Hood to Fender Bumper Kit

1962-65 Fairlane

1962-63 Meteor

(Stock # B16-24950-031)

**OEM # C2OZ-16758-B set . . . . . 5.95**



## Hood Bumper

Push in style - hood to fender - requires 4

1966-69 Fairlane and Torino

1966-70 Comet

(Stock # B16-24950-060)

**OEM # C6OZ-16758-A each. . . . . .95**



## Hood Bumper

Push in style - hood to fender - requires 4

1970-71 Torino

(Stock # P16-24950-075)

**OEM # C7AZ-16758-A each. . . . . 2.95**



## Cowl to Hood Bumper

1963-64 Fairlane

1963 Meteor

(Stock # B16-24965-040)

**OEM # C3OZ-16763-A pair . . . . . 11.95**



## Radiator Support Hood Bumper

5/16" - 18 - rubber top

1962-67 Fairlane

(Stock # P16-24965-050)

**OEM # C5ZZ-16763-A each . . . . . 2.95**



## Radiator Support Hood Bumper

5/16" - 18 - rubber top with hole in top

1965-72 Fairlane

1968-71 Torino

(Stock # P16-24965-055)

**OEM # C5ZZ-16763-B each . . . . . 3.95**

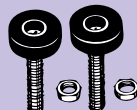

## Hood Bumpers

5/16" - 24

1962-65 Fairlane

(Stock # P16-24970-015)

**OEM # B9A-16769-A pair . . . . . 9.95**



## Hood Hinge Spring

1963-69 Fairlane and Torino

1964-69 Comet

1966-69 Montego

(Stock # B16-25000-040)

**OEM # C3OZ-16789-A each. . . . . 5.95**



## Hood Hinge Assembly

Show quality - just like original

1963-65 Fairlane

(Stock # B16-25015-030) - right hand

**OEM # C3OZ-16796-A each. . . . . 33.95**

(Stock # B16-25020-015) - left hand

**OEM # C3OZ-16797-A each. . . . . 33.95**



## Hood Bumper

Cowl to hood

1966-67 Fairlane

(Stock # BC3-76580-005)

**OEM # C6OZ-380478-S pair . . . . . 5.95**

Check out our Swap Meet Schedule to see when we will be in your area. Maybe even save some on shipping. Call one of the guys for more information!

**I cannot discover that anyone knows enough to say definitely what is and what is not possible.**

~ Henry Ford

*Check our prices on-line!  
See our website for current pricing.*



# 1962-72 Fairlane

Fenders & Hoods



### Hood Lip Molding Clip

1967 Fairlane - requires 6  
(Stock # F16-25055)  
**OEM # C5TZ-16B840-A each . . . . . 2.95**



### Hood Auxiliary Latch Catch

1970 Torino Fastback  
(Stock # P16-25115)  
**OEM # D0ZZ-16894-A each . . . . . 8.95**



### Hood Fastener Twist Handle

Chrome plated assembly - ready to install  
1970 Torino Fastback  
(Stock # P16-25120)  
**OEM # D0ZZ-16C896-A each . . . . . 0.00**



### Hood Safety Latch

1965 Fairlane  
(Stock # P16-25145-100)  
**OEM # C4DZ-16918-B each . . . . . 11.95**

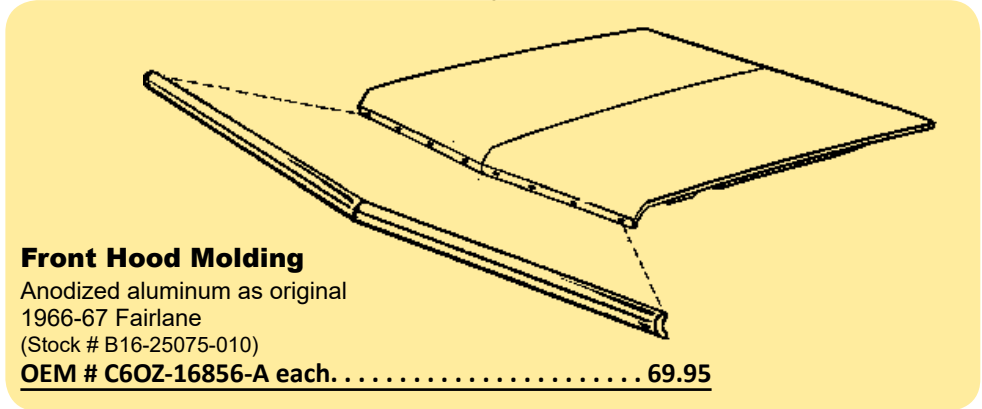

### Front Hood Molding

Anodized aluminum as original  
1966-67 Fairlane  
(Stock # B16-25075-010)  
**OEM # C6OZ-16856-A each . . . . . 69.95**



### Flush Mount Hood or Trunk Latch

Flush mount hood or trunk latch with a safety catch. Comes complete with mounting bolts.  
**HT 004 each . . . . . 91.95**

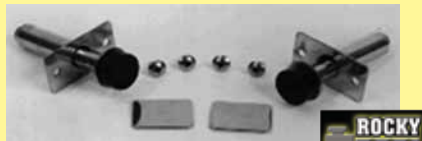

### Door or Trunk Poppers

These spring loaded stainless poppers can be used on doors or trunk. Priced per pair  
**PR 001 each . . . . . 41.95**



### Universal Trunk or Hood Prop

Made from quality aircraft aluminum our trunk prop features end over center lock measures 22" when opened and will support 60 lbs.  
**UTP 01 each . . . . . 87.95**



### Hood or Trunk Lift

This motorized unit extends 8" to 12" and will lift up to 250 lbs. Works well on trunks, hoods, or tilt front ends.  
**HTL 001 each . . . . . 271.95**



**We love when our customers bring their cars and trucks by. Feel free to drive yours up and show it off.**

# 1962-72 Fairlane

## In-Dash Tachometers and Speedometers



### American PLATINUM



**Need just a single gauge? We can order singles for you. Give us a call for availability and pricing!**

Electric Speedometer Kit  
1902..... 529.95

Mechanical Speedometer Kit  
1901..... 415.95

Kit Boxes	Range	Includes / Details	Elec	Mech
with Electric Speedo	120 MPH speedo, 100 PSI oil pressure, 100° to 250° F water temp, 8-18 volts and 240ΩE/33ΩF fuel level	Includes mounting hardware, lighting and all gauge senders. Speedo sender may be needed for #1902	1902	~
with Mechanical Speedo			~	1901

### ANTIQUE BEIGE

**Need just a single gauge? We can order singles for you. Give us a call for availability and pricing!**



Electric Speedometer Kit  
1809..... 406.95

Mechanical Speedometer Kit  
1808..... 514.95

Kit Boxes	Range	Includes / Details	Elec	Mech
with Electric Speedo	120 MPH speedo, 100 PSI oil pressure, 100° to 250° F water temp, 8-18 volts and 240ΩE/33ΩF fuel level	Includes mounting hardware, lighting and all gauge senders. Speedo sender may be needed for #1809	1809	~
with Mechanical Speedo			~	1808

### GOLDEN OLDIES



**Need just a single gauge? We can order singles for you. Give us a call for availability and pricing!**

Electric Speedometer Kit  
1502..... 558.95

Mechanical Speedometer Kit  
1501..... 463.95

Kit Boxes	Range	Includes / Details	Elec	Mech
with Electric Speedo	120 MPH speedo, 100 PSI oil pressure, 100° to 250° F water temp, 8-18 volts and 240ΩE/33ΩF fuel level	Includes mounting hardware, lighting and all gauge senders. Speedo sender may be needed for #1502	1502	~
with Mechanical Speedo			~	1501

Speedometers & Wipers

# 1962-72 Fairlane



## In-Dash Tachometers and Speedometers

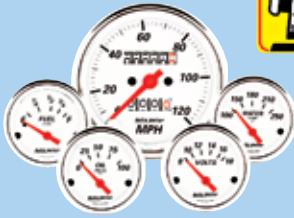

### Arctic White



Mechanical Speedometer Kit

Electric Speedometer Kit

5" Quad Gauge/Speedometer Kit

1300..... 406.95

1302..... 514.95

1303..... 694.95

Kit Boxes	Range	Includes / Details	Elec	Mech
with Electric Speedo	120 MPH speed, 100 PSI oil pressure, 100° to 250° F water temp, 8-18 volts and 240 Ω	Includes mounting hardware, lighting and all gauge senders. Speedometer sender may be needed for # 1302 and # 1303	1302	~
with Mechanical Speedo			~	1300
5" Quad Gauge/Elec Speedo			1303	~

### Designer Black™



5" Quad Gauge/Speedometer Kit

Mechanical Speedometer Kit

Electric Speedometer Kit

1403..... 694.95

1400..... 415.95

1402..... 529.95

Kit Boxes	Range	Includes / Details	Elec	Mech
with Electric Speedo	120 MPH speed, 100 PSI oil pressure, 100° to 250° F water temp, 8-18 volts and 240 Ω	Includes mounting hardware, lighting and all gauge senders. Speedometer sender may be needed for # 1402 and # 1403	1402	~
with Mechanical Speedo			~	1400
5" Quad Gauge/Elec Speedo			1403	~

### Old Tyme White



5" Quad Gauge/Speedometer Kit

Mechanical Speedometer Kit

Electric Speedometer Kit

1603..... 694.95

1601..... 406.95

1602..... 514.95

Kit Boxes	Range	Includes / Details	Elec	Mech
with Electric Speedo	120 MPH speed, 100 PSI oil pressure, 100° to 250° F water temp, 8-18 volts and 240 Ω	Includes mounting hardware, lighting and all gauge senders. Speedometer sender may be needed for # 1602 and # 1603	1602	~
with Mechanical Speedo			~	1601
5" Quad Gauge/Elec Speedo			1603	~

### Old Tyme Black



Electric Speedometer Kit

Mechanical Speedometer Kit

1709..... 455.95

1708..... 406.95

Kit Boxes	Range	Includes / Details	Elec	Mech
with Electric Speedo	120 MPH speed, 100 PSI oil pressure, 100° to 250° F water temp, 8-18 volts and 240 Ω	Includes mounting hardware, lighting and all gauge senders. Speedometer sender may be needed for # 1709	1709	~
with Mechanical Speedo			~	1708

Speedometer & Wipers

# 1962-72 Fairlane

## Universal Street Rod Panels

*Dakota Digital*



Six gauge flamed instrument panel system - 4"  
Panel dimensions - 24½" x 5¾"  
**VFD3-FLAME1 ..... 745.00**



Six gauge universal instrument system - Panel dimension - 18" x 4"  
**VFD3-CNTR-6 ..... 695.00**



Five gauge universal instrument system - Panel dimensions - 14½" x 4"  
**VFD3-CNTR-5 ..... 645.00**



Six gauge universal instrument system - Panel dimension - 18" x 4"  
**VFD3-SIDE-6 ..... 695.00**



Recessed billet aluminum panel is recessed ¾" to add another dimension to your flat dash. Five gauge recessed instrument system - Panel dimensions - 14" x 4½"  
**VFD3-REC-5 ..... 655.00**



Recessed billet aluminum panel is recessed ¾" to add another dimension to your flat dash. Six gauge recessed instrument system - Panel dimensions - 18" x 4½"  
**VFD3-REC-6 ..... 745.00**



**5 Gauge Universal Elliptical Designer Series**  
Dakota Digital Series III instrument systems offer the latest technologies and features for your custom vehicle. High brightness vacuum fluorescent displays provide a lifetime of trouble free use while offering increased accuracy and features! - Panel dimensions - 9½" wide x 4" tall x 1½" deep.  
**VFD3-1011 brushed satin ..... 660.00**  
**VFD3-1011-CH chrome ..... 0.00**

## RetroTech

This is the new RetroTech family of information systems. As the name suggests, the RetroTech information systems are truly a re-awakening of the retro artistry of the past, coupled with the cutting edge of technology of today. Offering an extensive array of features such as 0-255 mph/kph speedometer, 0-9990 Tachometer, 0-80 psi oil pressure, 0-300 degree water temperature, 8-17 volt voltmeter, 0-99% fuel level, million mile odometer, trip odometer, turn signals, high beam, gear shift, parking brake, cruise control, and check engine indicators! Also, several performance indications are standard features: 0-60 mph / -100 kph timer, 1/4 mile timer, 1/4 mile speed display, high speed recall, high RPM recall, as well as service and hour meters.



Five hole instrumentation system - Panel dimension 23⅞" x 5 7/8"  
**RET-2000 ..... 795.00**



Classic three hole layout - Panel dimension 23⅞" x 5⅞"  
**RET-2001 ..... 795.00**

**All instrument panels are available in blue, green and high contrast blue (teal) displays**

# 1962-72 Fairlane



## Jack Handle

With hinging built in socket on one end.  
Nice duplicate of the original handle.  
1965-70 Fairlane  
(Stock # P17-26025-100)

**OEM # C5ZZ-17032 each . . . . . 34.95**



## Jack Handle Base

Very nice reproduction base.  
1972 Torino  
(Stock # B17-26065-005)

**OEM # D2OZ-17088-D each . . . . . 9.95**



## Speedometer Cable

1962-64 Fairlane - 3 speed, 4 speed  
- Cruis-o-matic® or Ford-o-matic® - 6  
cylinder  
(Stock # X17-26165-055) - 67.06" long

**OEM # C2DZ-17260-J each . . . . . 29.95**

1962-64 Fairlane - 8 cylinder - 3 speed  
Standard transmission  
(Stock # P17-26165-060) - 59.06" long

**OEM # C3AZ-17260-C each . . . . . 16.95**

1964 Fairlane - 8 cylinder - 3 speed Stan-  
dard transmission - from 1/18/64

1965 Fairlane - 6 cylinder - 3 speed Stan-  
dard transmission  
(Stock # X17-26165-075) - 58.8" long

**OEM # C5DZ-17260-A each . . . . . 26.95**

1966 Fairlane - all - 289 3 speed Standard  
transmission

1968 Comet - 3 speed  
1970 Comet - 6 cylinder - with cruise  
control  
(Stock # B17-26165-100) - 56¾" long

**OEM # C6OZ-17260-A each . . . . . 31.95**

1968 Fairlane and Torino - 390 - 3 speed  
and 4 speed C4  
(Stock # P17-26165-120) - 66¾" long

**OEM # C7ZZ-17260-C each . . . . . 22.95**

1969-70 Comet and Montego - 3 speed  
(Stock # P17-26165-125)

**OEM # C9AZ-17260-C each . . . . . 14.95**

1972 Torino - all  
(Stock # B17-26165-160)

**OEM # D2OZ-17260-PD each . . . 16.95**



## Hold Down Bracket

Speedometer cable to transmission  
1966-72 Fairlane and Torino  
(Stock # F17-26185-015)

**OEM # B9TZ-17264-B each . . . . . 5.95**



## Speedometer Cable Lube

Comes in convenient easy to use tube.  
(Stock # A17-26170)

**OEM # A-17261-L each . . . . . 4.95**



## Speedometer Drive Gear

Give us your engine size, type of trans-  
mission, tire size, and rear axel ration.

The following fits 3 speed and automatic  
transmissions

1962-72 Fairlane - 18 teeth - gold or yel-  
low

(Stock # X17-26220-035) **Price Reduced!**  
**OEM # C0DD-17271-B each . . . . . 7.95**

1962-72 Fairlane - 16 teeth - burgundy  
(Stock # X17-26220-040) **Price Reduced!**

**OEM # C0DZ-17271-A each . . . . . 7.95**

1962-72 Fairlane - 19 teeth - beige  
(Stock # X17-26220-045) **Price Reduced!**

**OEM # C0DZ-17271-B each . . . . . 9.95**

1962-72 Fairlane - 20 teeth - black  
(Stock # X17-26220-050) **Price Reduced!**

**OEM # C1DZ-17271-A each . . . . . 7.95**

1962-72 Fairlane - 17 teeth - white  
(Stock # X17-26220-075) **Price Reduced!**

**OEM # C3DZ-17271-C each . . . . . 6.95**

1962-72 Fairlane - 21 teeth - red  
(Stock # B17-26220-085)

**OEM # C4OZ-17271-A each . . . . . 7.95**

1962-72 Fairlane - 19 teeth **Price Reduced!**  
(Stock # S17-26220-095)

**OEM # C7SZ-17271-C each . . . . . 2.95**

1962-72 Fairlane - 19 teeth - tan  
(Stock # F17-26220-100)

**OEM # C7VY-17271-A each . . . . . 5.95**



## Speedometer Drive Gear

Give us your engine size, type of trans-  
mission, tire size, and rear axel ration.

The following fit 4 speed transmissions

1962-72 Fairlane - 17 teeth - purple **Price Reduced!**  
(Stock # X17-26220-055)

**OEM # C2DZ-17271-G each . . . . . 9.95**

1962-72 Fairlane - 20 teeth - blue  
(Stock # X17-26220-060)

**OEM # C2DZ-17271-H each . . . . . 7.95**

1962-72 Fairlane - 16 teeth - orange  
(Stock # X17-26220-065)

**OEM # C2DZ-17271-J each . . . . . 7.95**

1962-72 Fairlane - 18 teeth - green or  
white  
(Stock # X17-26220-070)

**OEM # C2DZ-17271-K each . . . . . 7.95**

1962-72 Fairlane - 19 teeth - pink **Price Reduced!**  
(Stock # C17-26220-080)

**OEM # C4DZ-17271-A each . . . . . 7.95**

1962-72 Fairlane - 17 teeth - green  
(Stock # S17-26220-090)

**OEM # C7SZ-17271-A each . . . . . 9.95**

1962-72 Fairlane - 21 teeth **Price Reduced!**  
(Stock # X17-26220-122)

**OEM # E0TZ-17271-A each . . . . . 12.95**

Our management team is al-  
ways available for even the  
smallest of questions. Feel  
free to ask for Kevin or Reg.  
Either will be glad to help  
with the most minor detail.

Speedometer & Wipers

# 1962-72 Fairlane

Speedometers & Wipers



## Speedometer Drive Gear Retainer Clip

1962-72 Fairlane  
(Stock # X17-26265-155)  
**OEM # C1DZ-17292-A each . . . . . 4.95**



## Windshield Wiper Motor

2 Speed or Intermittent Wipers  
1972 Torino - with concealed wipers  
(Stock # P17-26455-400)  
**OEM # D2AZ-17508-A each . . . . . 84.95**



## Windshield Wiper Motor Gear Cover

Use with single or 2-speed motors  
1963-65 Fairlane  
1969-71 Fairlane  
(Stock # P17-26465-005)  
**OEM # C3AZ-17A511-C each . . . . . 11.95**



(A)



(B)

## Windshield Wiper Knob

Also has other dash knob applications  
1962 Fairlane - early '62 - wiper knob  
(Stock # X17-26475-150) - **white (A)**  
**OEM # C0DB-17513-W each . . . . . 7.95**  
1962 Fairlane - right hand air control  
(Stock # P17-26475-140) - **black**  
**OEM # C0AF-17513-A each . . . . . 7.95**  
1962-64 Fairlane - wiper knob  
(Stock # P17-26475-145) - **black (B)**  
**OEM # C0AZ-17513-B each . . . . . 7.95**



(A)



(B)

## Emergency Flasher Knob

1967-68 Fairlane - chrome with black trim  
(Stock # P17-26380-025) **(A)**  
**OEM # C7OZ-17513-A each . . . . . 12.95**  
1968-71 Fairlane - black  
(Stock # P17-264754-152) **(B)**  
**OEM # C8MY-17513-C each . . . . . 15.95**



(A)

## Windshield Wiper Arm

Polished stainless steel with chrome smooth end cap.  
1962-69 Fairlane, Comet and Torino  
(Stock # S17-26505-055) **(A)**  
**OEM # C1SZ-17526-A each . . . . . 19.95**  
1962-67 Fairlane - adjustable style  
(Stock # F17-26505-060)  
**OEM # C7TZ-17526-B each . . . . . 27.95**

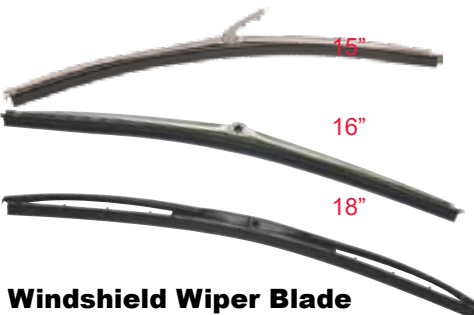

## Windshield Wiper Blade

1962-66 Fairlane  
(Stock # P17-26515-080) - **15" long** **Price Reduced!**  
**OEM # C3AZ-17528-J each . . . . . 19.95**  
1967-69 Fairlane  
(Stock # B17-26515-085) - **16" long**  
**OEM # C3OZ-17528-D each . . . . . 18.95**  
1970-72 Fairlane and Torino  
(Stock # P17-26515-100) - **18" long**  
**OEM # D3AZ-17528-A each . . . . . 17.95**



## Windshield Wiper Adapter and Connecting Arm Clip

1966-72 Fairlane - used with windshield wipers  
1970-71 Fairlane and Torino - attaches headlight motor cover  
(Stock # P17-26525-010)  
**OEM # C5ZZ-17531-A each . . . . . .95**

**Obsolete & ClassicAutoParts, Inc.**

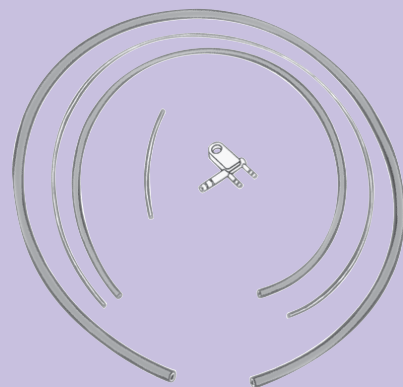

## Windshield Washer Hose and Tee Kit

1966-67 Fairlane  
(Stock # X17-26560-215)  
**OEM # C6OZ-17543-K each . . . . . 8.95**  
1968-69 Fairlane and Ranchero  
(Stock # X17-26560-235)  
**OEM # C8OZ-17543-K each . . . . . 10.95**

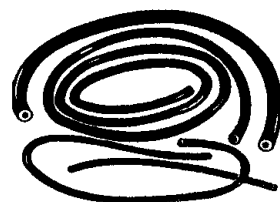

## Windshield Wiper Hose

Sold per foot  
(Stock # P17-26560-030) - **3/4" ID**  
**OEM # D3PZ-17543-B per foot . . . . . 1.95**  
(Stock # P18-29100-005) - **5/16" ID**  
**OEM # 8A-18970 per foot . . . . . .50**



## Windshield Wiper and Washer Switch

7 terminals - use with 2 speed wipers  
1970-71 Fairlane and Torino  
1970-71 Montego  
(Stock # B17-26590-040)  
**OEM # D0OZ-17A553-A each . . . . . 29.95**

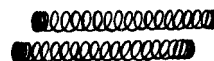

## Wiper Motor Brush Spring

Use with single or 2 speed motors  
1965-71 Fairlane - all  
1972 Torino - without concealed wipers  
(Stock # P17-26685)  
**OEM # C5AZ-17B599-A each . . . . . 4.95**

# 1962-72 Fairlane



### Windshield Washer Hose Tee

Nylon - "T" shaped  
 1962-67 Fairlane  
 1966-68 Comet and Montego (A)  
 (Stock # P17-26690)  
**OEM # C0AB-17A601-A each . . . . .95**  
 'F' shaped  
 1967 Fairlane and Comet (B)  
 (Stock # S17-26690-010)  
**OEM # C7SZ-17A601-A each . . . . .1.95**  
 'F' shaped  
 1968-69 Fairlane and Montego (C)  
 (Stock # S17-26690-010)  
**OEM # C8OZ-17A601-A each . . . . .2.95**



### Washer Nozzles

With rubber tips.  
 1966-72 Fairlane  
 (Stock # P17-26695)  
**OEM # C5AZ-17A602-B pair . . . . .7.95**



### Windshield Washer Bag

1962-65 Fairlane - red with screw top  
 (Stock # P17-26720-050) (A)  
**OEM # C1RZ-17618-A each . . . . .45.95**  
 1962-64 Fairlane - black with screw top  
 OEM # P17-26720-045)  
**OEM # C1AZ-17618-EA each . . . . .18.95**  
 1965-67 Fairlane/Comet - black with flip top  
 (Stock # P17-26720-040) (B)  
**OEM # C1AZ-17618-E each . . . . .21.95**



### Windshield Washer Reservoir

Blow molded plastic container  
 1967-68 Fairlane  
 (Stock # B17-26720-060)  
**OEM # C7OZ-17618-A each . . . . .29.95**



### Windshield Washer Caps

1962-64 Fairlane - screw type cap  
 (Stock # P17-26720-030) (A)  
**OEM # C1AZ-17618-CAP each . . . . .0.00**  
 1966-67 Fairlane - screw type cap  
 (Stock # S17-26740) (B)  
**OEM # B8S-17632-A each . . . . .4.95**  
 1967-68 Fairlane - for blown type can  
 (Stock # P17-26740-010) (C)  
**OEM # C7AZ-17632-A each . . . . .3.95**



### Washer Bag Mounting Bracket

1962-64 Fairlane (A)  
 (Stock # P17-26750-005)  
**OEM # C1AB-17651-A each . . . . .17.95**  
 1965-66 Fairlane  
 1966 Comet (B)  
 (Stock # P17-26750-010)  
**OEM # C4AZ-17651-A each . . . . .7.95**



### Windshield Washer Pump Motor

1965-66 Fairlane - 1 wire type  
 (Stock # P17-26770) (A)  
**OEM # C1AZ-17664-C each . . . . .49.95**  
 1966-68 Fairlane - 2 wire type  
 (Stock # P17-26770-015) (B)  
**OEM # C5AZ-17664-A each . . . . .59.95**



### Windshield Washer Pump

1969-72 Fairlane and Torino  
 1969-70 Montego  
 (Stock # P17-26770-030)  
**OEM # C9AZ-17664-A each . . . . .15.95**



### Washer Pedal Pad

1967 Fairlane  
 (Stock # P17-26770-020)  
**OEM # C7ZZ-17664-A each . . . . .2.95**



### Fiberglass Front Valance Panels

High quality reproduction fiberglass front valances are now available to replace damaged originals for 70/72 Torino and Ranchero. Manufactured to replace steel original valence. These come primed and ready for paint.

1970-71 Torino and Ranchero (A) **Price Reduced!**  
 (Stock # B17-26735)  
**OEM # D0OZ-17626-A each . . . . .209.95**  
 1972 Torino and Ranchero  
 (Stock # B17-26735-005) **Price Reduced!**  
**OEM # D2OZ-17626-B each . . . . .209.95**



Please allow 7-14 days  
 for Special Orders!

# 1962-72 Fairlane



### Outside Rearview Mirror

Chrome plated 2 hole mount style.  
1962-65 Fairlane  
(Stock # P17-26840-010)

**OEM # B5AZ-17696-2H each . . . 29.95**

### Rear View Mounting Hardware

Fits the above mirror - sold per mirror  
1962-65 Fairlane  
(Stock # P17-26840-015)

**OEM # B5AZ-17696-2HMB set . . . 1.95**



### Outside Rearview Mirror

Standard round head mirror  
1962-65 Fairlane  
(Stock # P17-26840-060)

**OEM # C3RZ-17696-R each . . . . 34.95**

### Rearview Mounting Hardware

Fits the above mirror  
1962-65 Fairlane  
(Stock # F17-26840-054)

**OEM # C3RZ-17696-RMK set . . . . 3.95**



### Outside Rearview Mirror

Round head - with paper gasket and hardware  
1963-66 Fairlane  
1966 Comet

(Stock # S17-26840-040)

**OEM # C1SZ-17696-B each . . . . 139.95**

**Friend us on Facebook and follow us on Twitter. You never know what you might be in for.**



### Outside Rearview Mirror

Left side remote mirror - complete with remote control cable, mounting gasket and hardware. Mirror and remote are chrome plated.

1964 Fairlane  
(Stock # P17-26815-125)

**OEM # C5ZZ-17682-B each . . . . 74.95**

### Dummy Remote Mirror

Right side dummy remote mirror - matches the above Left hand remote mirror.

1964 Fairlane  
(Stock # P17-26840-080)

**OEM # C5ZZ-17696-RRM each . . 99.95**



### Outside Rearview Mirror

With mounting pad and fasteners.

1965-66 Fairlane  
(Stock # P17-26840-065) - fits either side

**OEM # C5AZ-17696-F each . . . . 125.95**



### Outside Rearview Mirror Mounting Repair Kit

This kit is used to repair over-sized holes on the doors. Chrome plated screws and rubber with brass inserts for years of use.

1967-72 Fairlane and Torino  
(Stock # B17-26840-097)

**OEM # C7AZ-17696-MK kit . . . . . 3.95**



### Outside Rearview Mirror

Left hand remote mirror complete with remote control, gasket and mounting hardware.

1967 Fairlane and Comet  
(Stock # P17-26815-127)

**OEM # C7AZ-17682-B each . . . . 84.95**



### Outside Rearview Mirror

Remote style mirror - complete. Super quality featuring AAA chrome.

1967-69 Fairlane  
(Stock # P17-26840-110) - right hand

**OEM # C8AZ-17696-AR each . . . 69.95**

(Stock # P17-26840-112) - left hand

**OEM # C8AZ-17696-ER each . . . 117.95**



Price Reduced!

### Outside Rearview Mirror

Chrome plated with a rectangular head.  
1967-75 Fairlane and Torino/Comet and Montego

(Stock # P17-26840-130) - fits either side

**OEM # D4AZ-17696-A each . . . . 54.95**

**Don't forget to join our e-mail list. We send out e-mail specials, and you don't want to miss out!**

# 1962-72 Fairlane



### Outside Rearview Mirror Remote Knob Repair Kit

This repairs the small chrome remote knob that screws against the remote cable.

1969-72 Fairlane and Torino  
(Stock # P17-26890)

**OEM # D6AZ-17B718-A each . . . 11.95**



### Inside Rearview Mirror Bracket

1963-64 Fairlane - Hardtop and Convertible

(Stock # S17-26845-005) **(A)**

**OEM # C1SZ-17698-C each . . . . 14.95**

Glue on ball type.

1965-67 Fairlane - Hardtop

1968-69 Fairlane and Torino  
(Stock # S17-26850) **(B)**

**OEM # C1SZ-17698-D each . . . . . 9.95**



### Mirror Bracket

The flat type that glues to the windshield.

1969-72 Fairlane

1970-71 Montego

(Stock # P17-26850-010)

**OEM # C9AZ-17698-A each . . . . . 3.95**

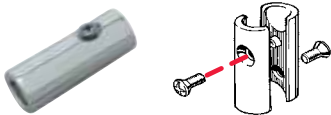

### Inside Rearview Mirror Arm

Chrome plated.

1964-69 Fairlane - Hardtop

(Stock # S17-26835-095)

**OEM # C2SZ-17690-F each . . . . . 10.95**



### Inside Rearview Mirror

Ball type mount - see saw day/night version

1963-66 Fairlane and Comet - Hardtop

1966 Fairlane and Comet - Convertible

(Stock # S17-26860-085)

**Price Reduced!**

**OEM # C1SZ-17700-D each . . . . . 84.95**



### Inside Rearview Mirror

Shaft type mount - see saw day/night version

1963-66 Fairlane - Hardtop

1966 Fairlane - Convertible

(Stock # P17-26860-103)

**OEM # C5ZZ-17700-C each . . . . . 26.95**



### Inside Rearview Mirror

Standard ball type mount - NON day/night

1964-65 Fairlane - Sedan and Station

Wagon

(Stock # P17-26860-090)

**OEM # C3AZ-17700-B each . . . . . 69.95**



### Inside Rearview Mirror

Twist type day night style

1963-67 Fairlane - Hardtop and Convertible

(Stock # S16-26860-100)

**OEM # C4SZ-17700-A each . . . . . 74.95**



### Inside Rearview Mirror

Day night style - black vinyl covered

1967 Fairlane

(Stock # P17-26860-105)

**OEM # C7AZ-17700-A each . . . . . 34.95**

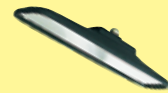

### Inside Rearview Mirror

Day/Night Style - ball type mount

1967-69 Fairlane/Comet

(Stock # F17-26860-112)

**OEM # C7AZ-17700-G each . . . . . 49.95**



### Inside Rearview Mirror

Day/Night Style - black

1970-71 Fairlane and Torino

1970-73 Comet

(Stock # P17-26860-120)

**OEM # C8AZ-17700-A each . . . . . 43.95**



### Inside Rearview Mirror

Black vinyl covered - 2 1/2" x 12"

1972 Fairlane and Torino

(Stock # P17-26860-125)

**OEM # D0AZ-17700-A each . . . 107.95**



**New!**

### Inside Rear View Mirror

Universal windshield mount rear view mirror. Adjustable pivot mount attaches directly to the windshield glass. Adhesive included.

(Stock # R17-26815-333)

**OEM # HR-17682 each . . . . . 49.95**

**Call Us:**  
**1-800-654-3247**

# 1962-72 Fairlane

Mirrors & Bumpers



## Outside Rearview Mirror Mounting Gaskets

1962-64 Fairlane  
Narrow pad - fits stock # C3RZ-17696-R (Stock # P17-26900-015)

OEM # C3RZ-17724-AR each. .... 3.95

1962-65 Fairlane  
Fits stock # B5AZ-17696-2H (Stock # P17-26900-005)

OEM # B5A-17724-R each. .... 3.95

1964-65 Fairlane  
For remote mirrors - fits stock # C5ZZ-17696-B

(Stock # P17-26900-025)

OEM # C5ZZ-17724-AR each. .... 3.95

1965-66 Fairlane  
Fits stock # C5AZ-17396-F (Stock # P17-26900-022)

OEM # C5AZ-17724-A each. .... 9.95

1967 Fairlane  
Fits either side remote mirror - fits stock # C7AZ-17696-B

(Stock # B17-26900-030)

OEM # C7OZ-17724-A each. .... 9.95

1972 Torino Sport and Ranchero (Stock # B17-26900-050)

OEM # D2OZ-17724-BC pair .... 11.95

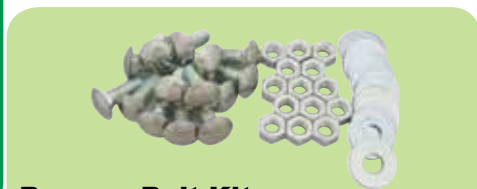

## Bumper Bolt Kit

Does front and rear bumpers  
1962 Fairlane

(Stock # B17-26975-080) - 42 pieces

OEM # C2OZ-17758-BK set .... 59.95



## Bumper Bolt Kit

Does front and rear bumpers  
1963 Fairlane

(Stock # B17-26975-090) - 57 pieces

OEM # C3OZ-17758-AK set .... 78.95



## Fiberglass Front or Rear Bumper Brackets

These are sold in front pairs or rear pairs. Specify front or rear when ordering.

1964 Fairlane (Stock # B17-26955-068)

OEM # C4OZ-17754-FG pair ... 129.95

1966-67 Fairlane (Stock # B18-26955-155) - front

OEM # C6OZ-17754-FG pair ... 129.95

1966-67 Fairlane (Stock # B17-26960-145) - rear

OEM # C6OZ-17755-FG pair ... 129.95

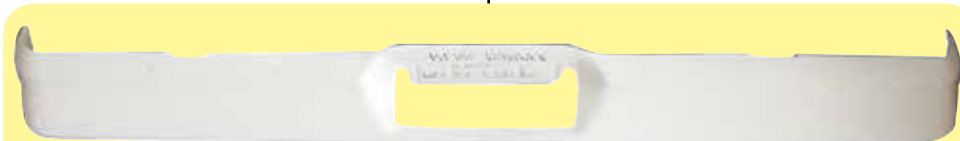

## Fiberglass Front Bumpers

Superb quality fiberglass bumpers. Made here in the USA and in primer - ready to paint.

1963 Fairlane (Stock # B17-26960-144)

OEM # C3OZ-17757-FGSP0 each ..... 309.95

1964 Fairlane (Stock # B17-26970-090)

OEM # C4OZ-17757-FGSP0 each ..... 229.95

1965 Fairlane (Stock # B17-26970-112)

OEM # C5OZ-17757-FGSP0 each ..... 309.95

1966-67 Fairlane (Stock # B17-26970-130)

OEM # C6OZ-17757-FGSP0 each ..... 309.95

1967 Ranchero (Stock # B17-26970-145)

OEM # C7OZ-17757-FG each. .... 309.95

1968-69 Torino (Stock # B17-26970-152)

OEM # C8OZ-17757-FG each. .... 309.95

1970-71 Fairlane and Torino (Stock # B17-26970-155)

OEM # D0OZ-17757-FG each ..... 279.95



## Bumper Bolt Kit

Does front and rear bumpers

1965 Fairlane - 36 pieces

(Stock # B17-26975-105)

OEM # C5OZ-17758-AK set. .... 51.95

1970 Torino - 24 pieces

(Stock # B17-26975-120)

OEM # D0OZ-17758-AK kit .... 23.95

## Bumper Bolt

7/16" - 14 x 1 1/4"

1962-67 Fairlane  
1970 Comet and Montego  
(Stock # P17-26975-055)

OEM # B9A-17758-A each. .... 1.95

## Bumper Bolt

7/16" - 14 x 1 1/4"

1965 Fairlane  
1968-69 Fairlane  
(Stock # P17-26975-085)

OEM # C3AZ-17758-A each. .... 1.95



## Bumper Wave Washer

1965-71 All  
(Stock # P17-27250)

OEM # C5ZZ-17A924-A each. .... .95

Please allow 7-14 days for Special Orders!

# 1962-72 Fairlane

**Special  
ORDER**



(A)



(B)

## Fiberglass Front Bumper Stone Deflectors

Replace your bent or rusted stone deflector with a new fiberglass reproduction. Quality manufactured in the USA.

1966-67 Fairlane/Ranchero (A)  
(Stock # B17-27030-025)  
**OEM # C6OZ-17779-A each . . . . . 169.95**

1968-69 Fairlane and Torino/Ranchero (B)  
(Stock # B17-27030-030)  
**OEM # C8OZ-17779-B each . . . . . 215.95**



## Front Spoiler - Black ABS

Bolts right on to your lower valence for that ultra high performance appearance. This was not offered original from the factory, but a popular after market accessory. Fits all front valences on 70/71 Torinos and Rancheros. Complete with mounting hardware and installation instructions.

1970-71 Torino and Ranchero  
(Stock # B17-27085) **Price Reduced!**  
**OEM # D0OZ-17794 each . . . . . 119.95**

1970-71 Cyclone and Montego  
(Stock # B17-27090-022)  
**OEM # D0OZ-17794-B each . . . . . 329.95**



## Fiberglass Rear Bumpers

All of our fiberglass parts are made of high quality fiberglass and are manufactured to fit and appear like your original sheet metal part. Fiberglass bumpers feature a white gel-coat will need to be painted. They are not chrome.

1963-64 Fairlane  
(Stock # B17-27230-090)  
**OEM # C4OZ-17906-FG each . . . . . 309.95**

1966-67 Fairlane  
(Stock # B17-27230-140)  
**OEM # C6OZ-17906-FG each . . . . . 309.95**

1968-69 Torino  
(Stock # B17-27230-147)  
**OEM # C8OZ-17906-FG each . . . . . 309.95**

1966-71 Ranchero  
(Stock # B17-27230-152) **New!**  
**OEM # D0OZ-17906-FG each . . . . . 279.95**

1970-71 Torino  
(Stock # B17-27230-153) **New!**  
**OEM # D0OZ-17906-FGB each . . . . . 279.95**

**Special  
ORDER**



## Bumper Guard Pad

For front or rear. This is the rubber strip that bolts into the bumper guard.

1971 Torino and Ranchero  
(Stock # B17-27120-005)  
**OEM # D1OZ-17A807-A each . . . 23.95**

1972 Torino and Ranchero  
(Stock # M17-27130-010)  
**OEM # D1MY-17A812-B each . . . 23.95**



## Rear Bumper Stone Deflector Seal

Fits between rear bumper and body of car.

1962-65 Fairlane  
(Stock # B17-27125-045)  
**OEM # C2OZ-17808-A each . . . . 35.95**

1966-69 Ranchero and Station Wagon  
(Stock # B17-27125-065)  
**OEM # C6OZ-17808-C each . . . . 35.95**

I want you to check out our website for easy shopping and current prices for anything you may need. Don't



want to order online? Just give us a call and we'll be happy to help!

**Call Us:**  
**1-800-654-3247**

Mirrors & Bumpers

# 1962-72 Fairlane

Shocks, Radios & Heaters



## Shock Absorbers

1962-65 Fairlane  
(Stock # B18-28155-037) - front  
**OEM # C2OZ-18124-A each . . . . 31.95**

1966-71 Fairlane  
(Stock # B18-28155-169) - front  
**OEM # C6OZ-18124-A each . . . . 31.95**

1962-70 Fairlane and Comet  
1968-71 Torino  
(Stock # X18-28155-025) - rear **Price Reduced!**  
**OEM # C1DZ-18124-C each . . . . 44.95**

1972 Torino  
(Stock # B18-21855-055) - front  
**OEM # D2OZ-18124-A each . . . . 0.00**



## T-bolt Clamp

Designed to mount the rolled edge megaphones onto your tail pipe - 2 1/4"  
(Stock # V18-28240-030)  
**OEM # B-18259-CLA each . . . . . 5.95**



## Rectangular Exhaust Tip

Oval cone shape, tip fits 2" outer diameter exhaust pipe. 11 1/4" long, taper from 3/16" to 5" with 30" cut. Universal application.  
(Stock # V18-28240-035)  
**OEM # B-18259-RET each . . . . . 29.95**

**Friend us on Facebook and follow us on Twitter. You never know what you might be in for.**

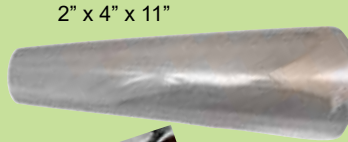

## Chrome Megaphone Exhaust Tips

Feature a rolled edge and your choice of an angles or straight design. The clamp on style requires the use of B-18259-CLA clamp to mount onto the tail pipe.

2 1/4" x 4" x 10 1/2" - Angled - clamp on  
(Stock # V18-28240-015)  
**OEM # B-18259-AC each . . . . . 53.95**

2" x 4" x 11" - Angled - weld on  
(Stock # V18-28240-020)  
**OEM # B-18259-BA each . . . . . 64.95**

2 1/4" x 4" x 10 1/2" - Straight - clamp on  
(Stock # V18-28240-040)  
**OEM # B-18259-SC each . . . . . 64.95**

2" x 4" x 11" - Straight - weld on  
(Stock # V18-28240-025)  
**OEM # B-18259-BS each . . . . . 64.95**



## Air Conditioner and Heater Vacuum Control Motor Assembly

Located on plenum chamber. Cut arm to required length.  
1966-68 Fairlane - with integral air - air conditioner and heater door  
1966-68 Comet  
(Stock # P18-28305)  
**OEM # COAF-18A318-B each . . . 59.95**

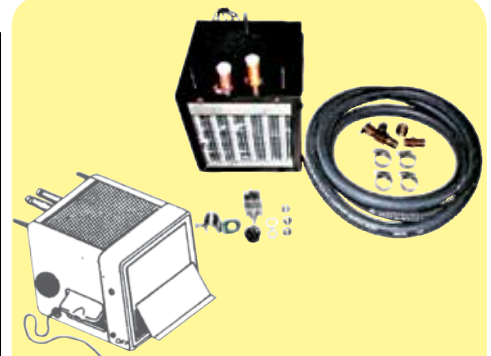

## Compact Heater Unit - 12 volt

Compact replacement units, ideal for original cars or just a good reliable heater. Retains the old fashion design measuring 7" high by 6 3/4" wide and 6 3/4" deep. Each one comes complete with hoses, clamps, connector, shut off valve, mounting templates and switch. Specifications: 12,500 BTU per hour - 130 CFM - black case finish - heavy duty motor - all metal construction - heavy duty core.

Ford® and Mercury® All  
(Stock # V18-28440) - 12 volt  
**OEM # B-18450-12V each . . . . 339.95**



## OEM Style Heater Defroster Plenum

1966-67 Fairlane - without AC  
(Stock # B18-28465-012)  
**OEM # C6OZ-18471-A each. . . . 194.95**



## OEM Style Heater Defroster Plenum

1966-67 Fairlane - with AC  
(Stock # B18-28465-013)  
**OEM # C6OZ-18471-B each. . . . 181.95**



# 1962-72 Fairlane

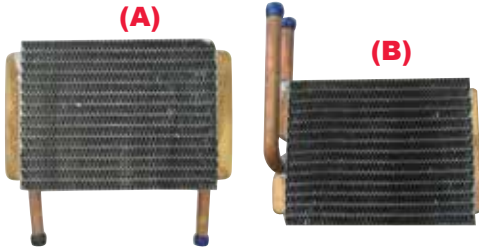

### Heater Core

1962 Fairlane - with heater  
 1962-63 Meteor (A)  
 (Stock # P18-28480-015)  
**OEM # C2AZ-18476-A each . . . 132.95**  
 1963-65 Fairlane - with heater  
 1962-63 Meteor - with 2" core  
 (Stock # P18-28480-025)  
**OEM # C3AZ-18476-A each . . . . 86.95**  
 1966 Fairlane - with integral air (B)  
 (Stock # B18-28480-065)  
**OEM # C6OZ-18476-C each . . . . 68.95**  
 1966-70 Fairlane - without air conditioning  
 (Stock # X18-28480-050)  
**OEM # C6DZ-18476-A each . . . . 58.95**

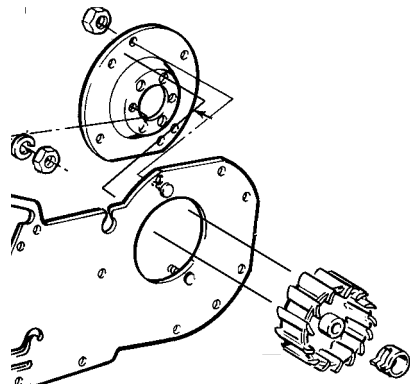

### Heater Blower Wheel

1971-72 Fairlane and Torino  
 (Stock # P18-28555-005)  
**OEM # D0AZ-18504-A each . . . . 21.95**



### Heater or Air Conditioner Knobs

Chrome - set of 3  
 1968-69 Comet and Montego  
 (Stock # X18-28570-022)  
**OEM # C8GY-18519-A set . . . . . 5.95**



### Heater/Wiper Knob

1972-79 Torino & Ranchero - heater, wiper control, integral AC, tailgate window control, heated Bakelite switch  
 (Stock # P18-28570-025)  
**OEM # D1AZ-18519-A each . . . . 17.95**



### Heater Motor

3 speed motor with 2 wires  
 1966-70 Fairlane/Comet and Montego  
 (Stock # P18-28575-022)  
**OEM # C5ZZ-18527-BR each . . . . 49.95**



### Defroster Control Cable

1964-66 Fairlane  
 (Stock # C18-28615-035) - 19" long  
**OEM # C4DZ-18548-A each . . . . 9.95**



### Heater Inlet Collar and Connector

1962-65 Fairlane  
 1962-63 Meteor  
 (Stock # B18-28670-015)  
**OEM # C2OZ-18A566-A each . . . 39.95**



### Heater Hose Clamp

For 5/8" I.D. Hose  
 1960-64 Fairlane - heater water hose  
 (Stock # P18-28695-020)  
**OEM # BPA-18572-A each . . . . . 1.95**



### Hose Clamp

Fits breather hose between valve cover and air cleaner  
 1963-66 Fairlane  
 (Stock # P18-28695-035)  
**OEM # C3AZ-18572-A each . . . . . 1.95**



### By-Pass Hose Clamp

1 1/8" diameter  
 1966-70 Comet  
 (Stock # P18-28695-025)  
**OEM # C0AZ-18572 each . . . . . 1.95**



### Heater Blower Motor Gasket

1962-69 Fairlane and Torino  
 (Stock # F18-28730-005)  
**OEM # C1UF-18583-A each . . . . . 9.95**



### Defroster, Fresh Air Intake or Air Conditioner Hose

Sold in three foot lengths. This is the original style hose reinforced with steel wire, but very easy and flexible to install.  
 1 1/2" - (Stock # P18-28735-025)  
**OEM # FAA-18584-1 1/2 each . . 19.95**  
 1 3/4" - (Stock # P18-28735-030)  
**OEM # FAA-18584-1 3/4 each . . 19.95**  
 2" - (Stock # P18-28735-035)  
**OEM # FAA-18584-2 each . . . . . 19.95**  
 2 1/4" - (Stock # P18-28735-045)  
**OEM # FAA-18584-2 1/4 each . . 19.95**  
 2 1/2" - (Stock # P18-28735-040)  
**OEM # FAA-18584-2 1/2 each . . 19.95**  
 2 3/4" - (Stock # P18-28735-050)  
**OEM # FAA-18584-2 3/4 each . . 19.95**  
 3" - (Stock # P18-28735-055)  
**OEM # FAA-18584-3 each . . . . . 19.95**  
 3 1/4" - (Stock # P18-28735-065)  
**OEM # FAA-18584-3 1/4 each . . 19.95**  
 3 1/2" - (Stock # P18-28735-060)  
**OEM # FAA-18584-3 1/2 each . . 19.95**  
 3 3/4" - (Stock # P18-28735-070)  
**OEM # FAA-18584-3 3/4 each . . 19.95**  
 4" - (Stock # P18-28735-075)  
**OEM # FAA-18584-4 each . . . . . 24.95**



# 1962-72 Fairlane



## USA-1



### Custom Autosound AM/FM Cassette with Auxiliary Input

If you want great sound at an affordable price then this is the radio for you! A quick review of the features and you'll realize why it's our best seller. Now with 200 watts this radio has outstanding features. These features include:

- PLL electronic synthesized tuner • 4 way fader • 24 pre-sets (6AM/18FM)
- Auto Reverse Cassette • Best station memory • Fast forward/rewind
- Auxiliary Input for direct connection to today's audio • Separate bass & treble control
- Pre-set scan • 200 watts high power • Scan & Seek tuning • 4 Channel RCA pre-out
- Digital clock

1966-70 Ranchero - 1968-79 Fairlane and Torino - 1966 & 1969-72 Comet

Specify Year and Body style when ordering

**RADIO-USA1 each . . . . . 214.00**

## USA-230



Do to the great success of our USA-630 radio we now bring you the USA-230. This new model radio has the same cosmetics as the USA-630 which has been a huge success. If you don't need USB/MP3 or CD changer control this is the model for you. An awesome looking radio at a great price. Radio has no cassette but comes with auxiliary audio input. If you have a portable MP3 player or Satellite radio just plug it into the Aux input and listen to it through this radio. This radio features:

- AM-FM Stereo • 200 Watts (4x50) • Auxiliary Input (RCA Rear) RCA to 1/8" pin jack included • Digital Clock • Electronic Tuner • 16 Pre-sets (4AM-12FM) • 4 Channel RCA Pre-outs • 4 way Fader • Power Antenna Lead

1966-70 Ranchero - 1968-79 Fairlane and Torino - 1966 & 1969-72 Comet

Specify Year and Body style when ordering

**RADIO-USA2 each . . . . . 225.00**

## USA-630



### In Dash AM/FM with USB, CD Changer Control and Auxiliary Input

AM/FM Radio with USB input for MP3/WMA file playback and direct CD Changer Controller. This AM/FM radio will control all functions of the optional Custom Autosound 10 disc CD changer from the buttons on the radio. And now features auxiliary input for iPod, satellite radio etc. The USB port is on an 14" extension that allows placement of your flash drive in the ashtray or glove box. No unsightly wires hanging from your dash. All radios are supplied with the correct surround bezel for your car. Check out these exciting features.

- AM-FM Stereo • 240 Watts • USB Port for Flash Memory MP3/WMA Playback • Direct 10 CD Changer Control • Alpha Numeric id3 LCD Display for MP3/WMA files • Electronic Tuning and Volume Control • 4 way Fader • Left Right Balance • Digital Clock • 2 Channel RCA Auxiliary Input for Satellite / iPod etc. • 16 Pre-sets (12FM-4AM) • 2 Pair RCA Pre amp outs • Separate Bass and Treble • USA/Euro Tuner • Power Antenna Lead •

1966-70 Ranchero - 1968-79 Fairlane and Torino - 1966 & 1969-72 Comet  
Specify Year and Body style when ordering

**RADIO-USA630 each . . . . . 269.95**

**RADIO-USA630CD (with optional 10 CD changer) set 479.00**

Shocks, Radios & Heaters



### Heater Switch Resistor Assembly

1962-67 Used with fresh air heater

(Stock # B18-28745-090)

**OEM # C2OZ-18591-A each. . . . . 21.95**



### Heater Hose Nipple (Elbow)

1962-72 Fairlane - straight

(Stock # M18-28775-005)

**OEM # 8M-18599 each . . . . . 9.95**

1961-67 Fairlane - 8 cylinder - 3/8" male

pipe

(Stock # P18-28775-015)

**OEM # C1AF-18599-A each. . . . . 12.95**



### Hot Water Heater Connecting Elbow

1963-70 Fairlane and Torino - 221, 260,

289, 302 - with 3/8" male pipe

(Stock # B18-28775-020)

**OEM # C3OZ-18599-A each. . . . . 9.95**

1965 Fairlane - 221, 260, 289

1965-70 Fairlane and Torino - 289, 302

1971-72 Torino - 302

(Stock # P18-28775-025)

**OEM # C6AZ-18599-B each. . . . . 18.95**



### Heater Hose Connector

1967-70 - 390, 428 - heater hose to intake

(Stock # P18-28771-035)

**OEM # C8AZ-18599-A each. . . . . 29.95**

1971 Torino/Montego

(Stock # P18-28775-040)

**OEM # D1AZ-18599-A each . . . . . 36.95**



# 1962-72 Fairlane



## SecretAudio

- AM/FM Stereo • Seek and Scan Tuning
- 4-way Fader • Separator Bass and Treble • 4 Channel RCA Pre-outs • CD Changer Options - Controlled by the Wireless Remote!

**Optional: iPod/USB MP3 interface available for this model!**

Secretaudio is a hidden audio system that offers great flexibility for mounting in any type of vehicle. The main receiver/amplifier unit is usually hidden under the seat or behind the dash. A 12' cord from the tuner/amp plugs into a LCD display. A 9' cord connects the optional CD changer to the tuner/amp.

Included with the system is a flush mount bezel for console or dash mounting. The small dimensions of the flush mount system allow you to install the LCD display almost anywhere. The LCD also comes with a bracket mount for easy installation in the glove box, under the dash, in the ashtray, sun visor, console, or wherever you choose. Since its only 3/4" deep, its especially handy for custom or Street Rod applications where there may be wiring or ducting routed behind the panel you wish to utilize for mounting. When your installation is finished, you'll be rewarded with a quality, professionally installed look.

The Secretaudio SS model remote is a 'RF' (radio frequency) remote. With the RF remote you do not have to be in direct line of sight with the display. In fact, you can use the RF remote from up to 40 feet away, and control all functions of the system and even the optional 10-disc changer.

Secretaudio is designed for installation flexibility. Included with the system is a flush mount bezel for console or custom mounting and a swivel bracket for under dash or ashtray etc.

- Secretaudio SS .....336.95
- Secretaudio SS+CD radio and CD changer .....509.95



Shocks, Radio & Heaters

## Hideaway Audio Solution

## USA-CD10



### Features:

- AM/FM Stereo 200 Watts (4x50)
- USB MP3/WMA Flash Drive Player
- Alpha Numeric Display for MP3 Files
- CD Changer Controller
- Auxiliary Input
- 4 Channel RCA Pre-Outs
- Subwoofer Pre-out
- 4-way Fader
- Digital Clocks

Hideaway 200 watt AM/FM CD controller with USB MP3 flash drive player. Featuring 'RF' (radio frequency) remote control. Ideal for Street Rods, Classics, Customs or any vehicle! Leave your original radio in tact! LCD display unit can be mounted almost anywhere and be controlled by wireless remote for up to 40' away. The tuner/amplifier unit can be hidden out of site - under seat or dash. Two mounting options included! Flush mount bezel and a swivel mount bezel. Please note: the above photos are a preliminary prototype.

**Please call for pricing and availability!**



### 10 Disc CD Changer

Works with USA-5, USA-6, USA-630, USA-66 and Secretaudio. Operates from the buttons on the radios. 1 bit 8x times oversampling. Twin digital-to-analog converter. 3-beam laser tracking. Disc select up/down. Track up/down. 2-way scan and shuffle. Play and pause control. Program repeat. Anti-shock and vibration free design. Designed for horizontal, vertical or 45° installation. Changer dimensions: 9 1/4" wide x 3 1/2" high x 6 3/4" deep.

- USA-CD10 .....259.95



# 1962-72 Fairlane

Shocks, Radios & Heaters

## Undercover Speakers



Custom Autosound designed and manufactured these speakers specifically for 'under seat' or horizontal 'wall' installations. They could be used on large parcel shelves, or wherever! Compact unit with one 5½" woofer and piezo tweeter in each enclosure. Under seat fit for most pre 1978 cars and trucks. 120 watt capacity! If you've got the space, Custom Autosound has the solution! Each enclosure measures 3" high x 8¼" wide x 11¼" long. Sold in pairs.

**Undercover I** .....119.95



Want a little more from your hidden speaker system? This is it! We have developed the Undercover II with an 8" woofer and 2 piezo tweeters in each box. This system can be mounted in many of the same locations as the regular Undercover. With the 8" woofer in Undercover II you get a much fuller, deeper sound. These are a great addition to Custom Autosound's Concours series radios with their 200 watt capacity. Measures 11" wide x 12½" deep x 3" high. Sold in pairs.

**Undercover II** ..... 139.95

## Digital To Go...

### iPod Mania



With so many iPod players sold, it's inevitable that some of you will want to connect your iPod player to your car stereo. They easily connect to Custom Autosound's CD controller head units with the iCAMKIT iPod connector. Once connected, you can charge your iPod and access your playlist from the controls on your radio. Connects to: 8-PIN DIN at Headunit.

Features include:

- Compatible with any iPod with bottom dock connector
- Power on automatic play function and power off automatic pause
- Automatic pause when switching to AM, FM, CD or TAPE
- No battery required
- Keeps your iPod charged at all times
- Direct connection with CD-quality sound
- ¼" stereo plug for other auxiliary input
- Use your head unit to change songs or fast forward and rewind
- Supports up to 9 play lists in "play list mode"

This adapter will give you the best possible sound from your iPod while playing through your car stereo. Simply plug the ICAMKIT into the CD changer port on the back of your Custom Autosound radio and plug in your iPod. The unit will turn on, turn off and charge your iPod. Song selection is made with the CD control buttons on your Custom Autosound radio, and includes playlist selection and random song selection. If you prefer, the thumb wheel controls on the iPod can be used. The ICAMKIT can be used with or without the Custom Autosound CD changer. If your iPod is not connected, the iCAMKIT can still be used to input audio from external devices such as satellite radio, portable CD, etc., via the ¼" stereo plug.

**iCAMKIT** .....109.00

### USB/MP3



If CDs or iPods just aren't your thing, not to worry - the CAM-US-BFLASH is an easy-to-connect USB port that can be connected with our CD controller radios. With the USBFLASH, you can plug in many USB devices and access compatible audio files. If you have a portable music player with a USB connection, you can easily attach it and play through the USB control. Or, if you have a micro USB memory drive - thumb drives, flash drives, jump drives, USB keys, etc. - on your key chain, you can connect and play the stored MP3 audio files through your car stereo. Connects to : 8-PIN DIN at Headunit.

Features:

- Compatible with any USB-compatible storage device
- Comes with SD card adapter - SD card NOT included
- Allows the use of the radio CD controls to change songs
- Exclusive built-in high quality MP3 decoder
- Power on automatic play function and power off automatic pause
- Automatic pause when switching to AM, FM, CD or TAPE
- No battery required
- Direct connection with CD quality sound
- ¼" stereo jack for other auxiliary input

This USB MP3 player will revolutionize the way you listen to music in your car. Simply plug the CAM-US-BFLASH into the CD changer port of your Custom Autosound radio and insert any USB flash drive. You can now play any MP3 stored on the drive. All control of song selection is through the radio CD control buttons. The CAM-US-BFLASH can be used with or without the Custom Autosound 10 CD changer. If you have a satellite radio or other audio device, you can input sound through the ¼" stereo jack and listen to it on your radio.

**CAM-US-BFLASH** .....139.00

# 1962-72 Fairlane



## Universal Owners I.D. Plate

This is a blank ID plate allowing you to engrave the year the car was built and the owners name. Ideal for any restoration.  
(Stock # Z18-28815-150)

**OEM # U-18650-OP each . . . . . 9.95**



## Identification Plate Rivets

Special rivets need to put the original stylev ID plates on your car.  
(Stock # P18-28815-060)

**OEM # COAZ-18650-MB set . . . . . 1.95**



## Black Radio Knobs

1962-71 Fairlane and Torino

For split shaft that comes out of the radio  
(Stock # P18-28915-070)

**OEM # COAZ-18805-B each. . . . . 7.95**

For shaft flat on one side

(Stock # P18-28915-075)

**OEM # COAZ-18805-BN each . . . . . 7.95**

For radio that pin in moulded inside knob  
(Stock # P18-28915-080)

**OEM # COAZ-18805-BS each. . . . . 7.95**



## Replacement Radio Speakers

These are standard speakers designed to go in the rear speaker area. We are listing these by size. Please measure before ordering. Fit many applications 1962-72.

(Stock # P18-28930-075) - 5" x 7"

**OEM # COAZ-18808-5X each. . . . . 28.95**

(Stock # P18-28930-080) - 6" x 9"

**OEM # COAZ-18808-6X each. . . . . 22.95**



## Original Style Front Speaker

Mono speaker - 5" x 7"

1967-73 Fairlane

(Stock # P18-28930-120)

**OEM # C7AZ-18808-A each. . . . . 18.95**

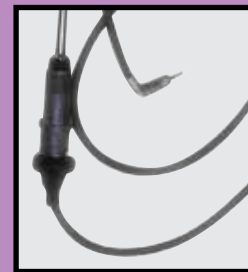

## Radio Antenna Kit

Includes base and mast assembly, rubber grommets, lead wire and mounting template.

1962 Fairlane

(Stock # X18-8950-210)

**OEM # C3DZ-18813-A kit . . . . . 125.95**

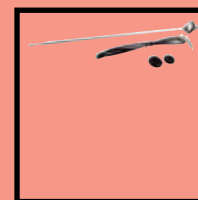

## Radio Antenna Kit

Includes base and mast assembly, rubber grommets, lead wire and mounting template.

1963-64 Fairlane

(Stock # P18-28950-205)

**OEM # C3AZ-18813-C kit. . . . . 125.95**



## Radio Antenna Kit

Includes base/mast assembly, rubber grommets, lead in wire and mounting template.

1965 Fairlane

(Stock # C18-28950-220)

**OEM # C4DZ-18813-A each. . . . . 49.95**

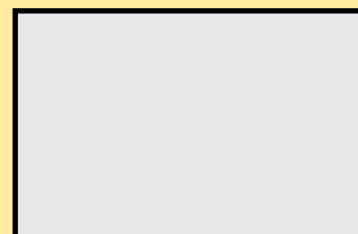

## Radio Antenna Kit

Made exactly like the original - complete with bezels, gaskets and antenna lead.

1966 Fairlane

(Stock # P18-28950-235)

**OEM # C5AZ-18813-A each. . . . . 125.95**

Shocks, Radio & Heaters



## Ford® Parts Tags

100 tags

(Stock # V18-28845-025)

**OEM # B-18657-TG set . . . . . 27.95**



## White Radio Knobs

Early 1962 Fairlane

For split shaft that comes out of the radio  
(Stock # X18-28915-090)

**OEM # C0DB-18805-W each. . . . . 7.95**

For shaft that is flat on one side and

comes out of the radio

(Stock # X18-28915-095)

**OEM # C0DB-18805-WN each . . . 7.95**

For type that shaft is moulded inside knob

(Stock # X18-28915-110)

**OEM # C0DB-18805-WS each. . . . . 7.95**

**For our International customers, we do offer a wire transfer for ordering. Inquire via phone or e-mail.**

# 1962-72 Fairlane

Shocks, Radios & Heaters



### Radio Antenna Kit

This is a Ford® replacement round base antenna that is highly requested by our local customers.

1962-67 Fairlane - all  
(Stock # P18-28950-237)

**OEM # C5ZZ-18813-A each . . . . . 19.95**



### Radio Antenna Kit

With tear drop mast - includes streamlined mast/base assembly - chrome base cover, base mounting pads, lead wire with plastic retainers, rubber grommets and mounting hardware and template for installation.

1967-71 Fairlane and Torino  
(Stock # B18-28950-266)

**OEM # C7OZ-18813-A each. . . . . 125.95**



### Radio Antenna Kit

Includes base and stainless steel areal, cable, chrome base cover, rubber mounting pad, retainers, screws and template.

1972 Fairlane and Torino  
(Stock # B18-28950-284)

**OEM # D2OZ-18813-A each . . . . . 98.95**



### Radio Antenna Base Pad

1962 Fairlane - for the C3DZ antenna  
(Stock # X18-28970-047)

**OEM # C3DZ-18818-S each . . . . . 9.95**

1963-65 Fairlane - rubber pad for the C4DZ and C3AZ antenna.  
(Stock # P18-28970-046)

**OEM # C3AZ-18818-S each . . . . . 9.95**



### Radio Condenser

1966-70 Fairlane and Torino  
(Stock # P18-28995)

**OEM # C6AZ-18827-A each . . . . . 9.95**

1972 Torino  
(Stock # B18-28995-010)

**OEM # D2OZ-18827-A each . . . . . 27.95**



### Antenna Lead in Grommet

Use with windshield washer kit for the front mount antenna.

1966 Fairlane  
(Stock # P18-29065)

**OEM # B5A-18912-A each. . . . . 3.95**



### Antenna Base Kit

1965 Fairlane  
(Stock # X18-29070-017)

**OEM # C4DZ-18919-A kit . . . . . 17.95**

**Price Reduced!**

**Drop by a see us the next time you are in town. We love to see our customers cars and hear their stories! And pick up that part you can't find while you are here!**



# 1962-72 Fairlane

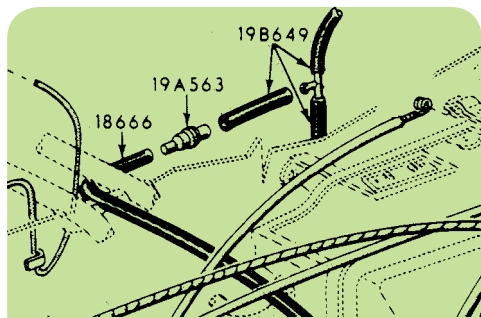

## Air Conditioner Vacuum Check Valve Assembly

1966-71 Fairlane/Torino  
(Stock # B19-30200)

**OEM # C6OZ-19A563-A each . . . . 0.00**



## Air Conditioner Lines to Dash Panel (Firewall Seal)

1962-64 Fairlane  
(Stock # P19-30250)

**OEM # C0AF-19B588-A each . . . . 6.95**



## Air Conditioner Compressor Crankshaft Seal Kit

1965-71 Fairlane/Torino  
(Stock # P19-30335-005)

**OEM # C9AZ-19655-B set . . . . . 24.95**



## Air Conditioner Registers

Chrome plated - sold in sets of 4  
1963-65 Fairlane  
(Stock # P19-30350-005)

**OEM # C3AZ-19A671-A set . . . . . 7.95**



## Air Conditioner Registers

Chrome plated - sold in sets of 4  
1966-70 Fairlane  
(Stock # P19-30350-010)

**OEM # C6AZ-19A671-A set . . . . . 23.95**



## AC Evaporator Side Register Retainer Clip

1963-65 Fairlane - spring clip  
(Stock # P19-30370)

**OEM # C3AZ-19A683-AR each . . 17.95**

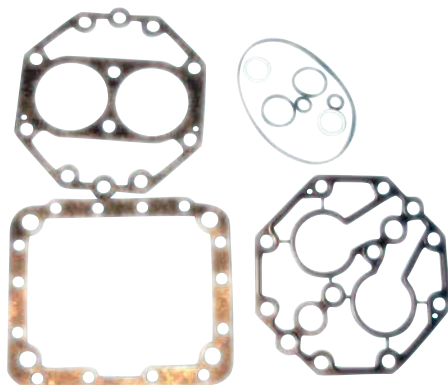

## AC Compressor Gasket Kit

1962-72 All - with York compressor  
(Stock # P19-30375-005)

**OEM # C8AZ-19B684-A kit . . . . . 41.95**



## AC Compressor Metal Tag

1962-72 All  
(Stock # P19-30385)

**OEM # C1AZ-19A688 each . . . . . 8.95**

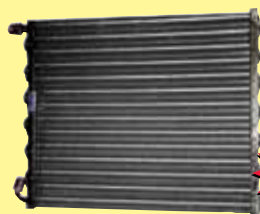

**Special ORDER**

## Air Conditioner Condenser Core

1964-65 Fairlane  
(Stock # P19-30410)

**OEM # C4AZ-19712-B each . . . . . 299.95**

1966 Fairlane - 6 cylinder and 289 - with integral AC

1967 Fairlane - 390 - with integral AC  
(Stock # B19-30410-010)

**OEM # C6OZ-19712-BSPO each . . . . 238.95**

1970-71 Torino - with integral AC  
(Stock # B19-30410-060)

**OEM # D1OZ-19712-ASPO each . . . . 264.95**

1972-74 Torino  
(Stock # B19-30410-065)

**OEM # D2OZ-19712-ASPO each . . . . 308.95**



## Heater Box Clamp

Spring steel clamp that holds both halves of the heater box together.

1972 Fairlane  
(Stock # B19-30480-050)

**OEM # C0DF-19A779-A each . . . . 9.95**



## AC Evaporator Expansion Valve

1968-71 Fairlane/Torino - with integral AC  
(Stock # B19-30530-010)

**OEM # C8OZ-19849-A each . . . . . 55.95**



## Air Conditioner Dehydrator and Receiver Assembly

1964-66 Fairlane - with hang on AC  
(Stock # P19-30575-005)

**OEM # C4AZ-19959-B each . . . . . 79.95**

**Check out our website for information, and to check on current prices!**

Check out our Swap Meet Schedule to see when we will be in your area. Maybe even save some on shipping. Call one of the guys for more information!

**Please allow 7-14 days for Special Orders!**

Air Conditioner Parts

# 1962-72 Fairlane



## Gen-II Super Cooler

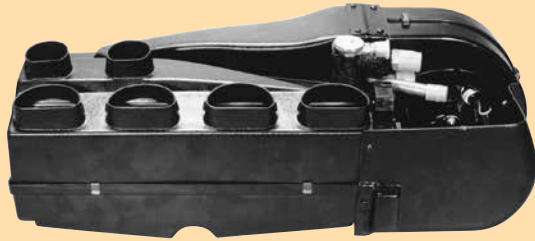

### Gen-II Super Cooler Systems

Comes complete with:

- Evaporator and mounting brackets
- Wiring harness
- A/C duct hose
- Drain kit
- Heater control valve
- Defrost option includes hoses and ducts

The absolute performance leader! State of the art Gen-II servo motor control technology is the foundation of our most popular heat and cool system ever. Amazing performance is achieved with the Gen-II Super's new "D" shaped outlets. As an added benefit, you can position all 4 louvers wherever you need them. The ideal system for the largest sedans and wagons. Features true bi-level operation in cool and heat modes and a more powerful dehumidified defroster mode.

**Heat, Cool and Defrost 61005-VUZ-A ..... 490.00**

### Gen-II Technology Benefits:

- High torque screw-drive servo motors control all butterfly airflow doors.
  - Increased travel on these doors allows much greater airflow.
  - Immediate response to control input and superior door sealing vacuum controls.
  - No reliance on engine vacuum - important with high performance engines.
- Re-engineered heating and cooling coil.
  - Increases cooling capacity by over 20% and heating capacity by over 100%.
- Re-engineered and computer aided design to evaporator case.
  - Optimized internal case design allows significant airflow volume increases.
  - Increased capacity and control of dehumidified defroster airflow.
  - Blower fan motor isolated on rubber mounts for quiet running and longer life.

## Gen-II Compact

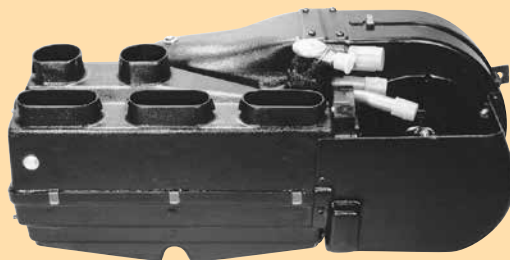

### Gen-II Compac Cooler Systems

Comes complete with:

- Evaporator and mounting brackets
- Wiring harness
- A/C duct hose
- Drain kit
- Heater control valve
- Defrost option includes hoses and ducts

Amazing performance in a compact system! State of the art Gen-II servo motor control technology makes this mid-sized package work better than most other's full-sized systems. Amazing performance with three vents allowing you to position louvers wherever you need them. The ideal system for the coupes and smaller sedans and wagons. Features true bi-level operation in cool and heat modes and a more powerful dehumidified defroster mode.

**Heat, Cool and Defrost 68000-VUZ-A ..... 470.00**

# 1962-72 Fairlane



## Gen-II Mini



### Gen-II Mini Cooler Systems

Comes complete with:

- Evaporator and mounting brackets
- Wiring harness
- A/C duct hose
- Drain kit
- Heater control valve
- Defrost option includes hoses and ducts

Gen-II technology for the smallest cars and trucks! State of the art Gen-II servo motor control technology is now incorporated into our smallest heat and cool system. All new CAD designed case allows more capacity and air flow than our original Compac systems. The ideal system for trucks and smaller hot rods. Features true bi-level operation in cool and heat modes and a more powerful dehumidified defroster mode.

**Heat, Cool and Defrost 66055 series . . . . . 470.00**

## Gen-II Mock-up Units

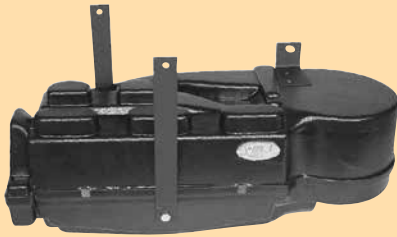

Gen-II Mini Mock-up

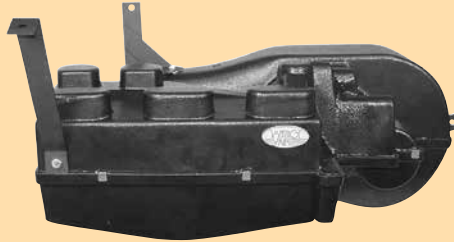

Gen-II Compac Mock-up

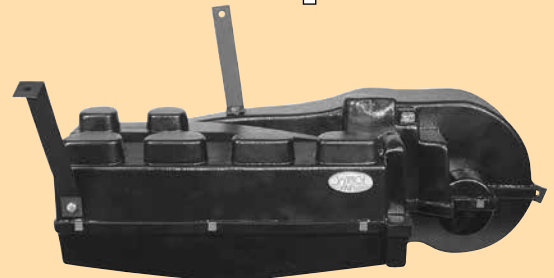

Gen-II Super Mock-up

The easiest way to fit your Gen-II into place. These mock-ups are representative cases with jack-nuts and brackets for each Gen-II system, but without the internal components so they are extremely light weight - helpful while holding the unit in place to determine fitment, mounting and hose routing. These mock-up units require a \$50.00 deposit plus shipping costs. Your \$50.00 will be credited to your Vintage Air Order!

Gen-II Mini	
<b>660050-VUA</b> . . . . .	<b>49.95</b>
Gen-II Compac	
<b>680000-VUA</b> . . . . .	<b>49.95</b>
Gen-II Super	
<b>610050-VUA</b> . . . . .	<b>49.95</b>

### Gen-II Super

### Gen-II Compac

### Gen-II Mini

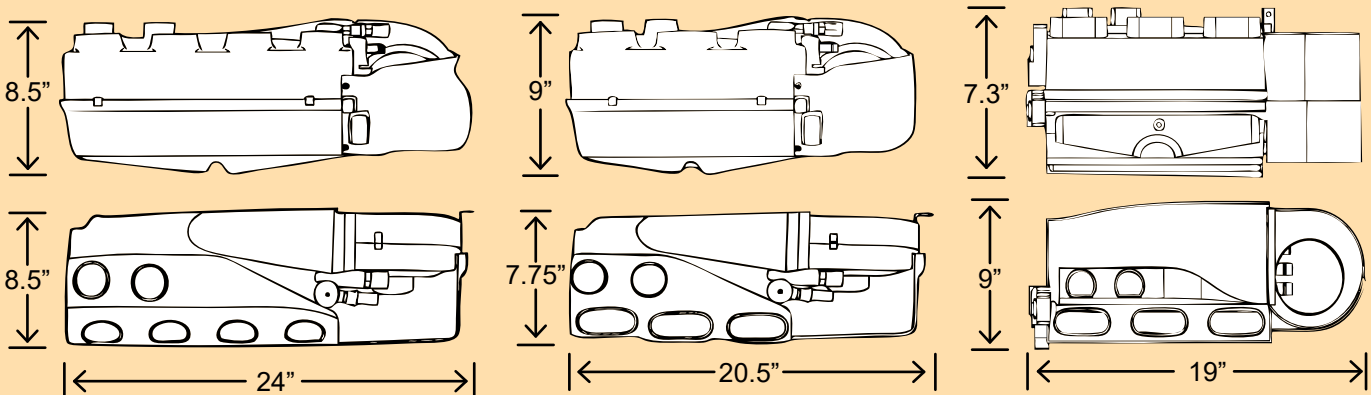

Air Conditioner Parts

# 1962-72 Fairlane

## Gen-IV Magnum

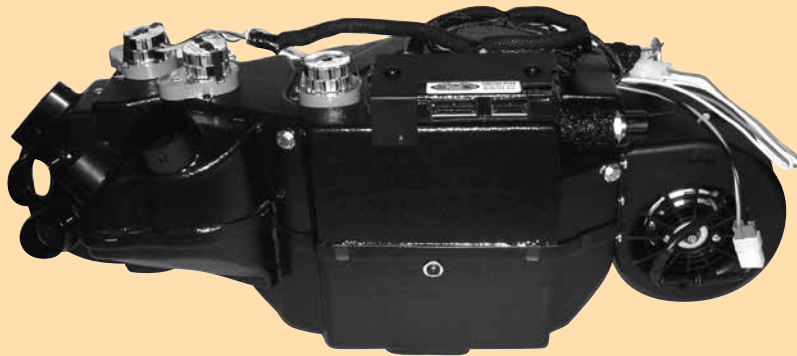

### Gen-IV Magnum Systems

Comes complete with:

- Evaporator and mounting brackets
- Wiring harness
- Electric solenoid heater control valve
- A/C duct hoses
- Drain kit
- Defrost kit including hoses and ducts

Gen-IV technology delivers OEM quality climate control! Now you can enjoy true bi-level, infinitely adjustable comfort in your classic car. This large system can handle even the largest sedan or wagon.

Heat, cool and defrost model

**Heat, Cool and Defrost 671400-VUZ** ..... **699.00**

### Gen-IV System features:

- Fully electronic operation. NO cable or vacuum controls
- Micro-processor controlled coil temperature monitor. No capillary tube to run!
- Separate high capacity heat and cool coils
- Aluminum plate/fin A/C coil - the most efficient evaporator design available
- Copper/brass parallel flow heater coil
- In full A/C mode air bypasses heater core, resulting in less restriction and increased airflow
- Blend air door for instant temperature adjustment
- Infinite dash/floor air bend
- Infinite defrost/floor air blend with dedicated defrost
- Positive shut off solenoid operated heater control valve in max A/C
- Polished Aluminum Streamline control panel

Note: The unique shape of the Gen-IV Magnum allows fitments in vehicles with high transmission tunnels and stepped firewalls, such as cars of the 1950" through the 1980's.

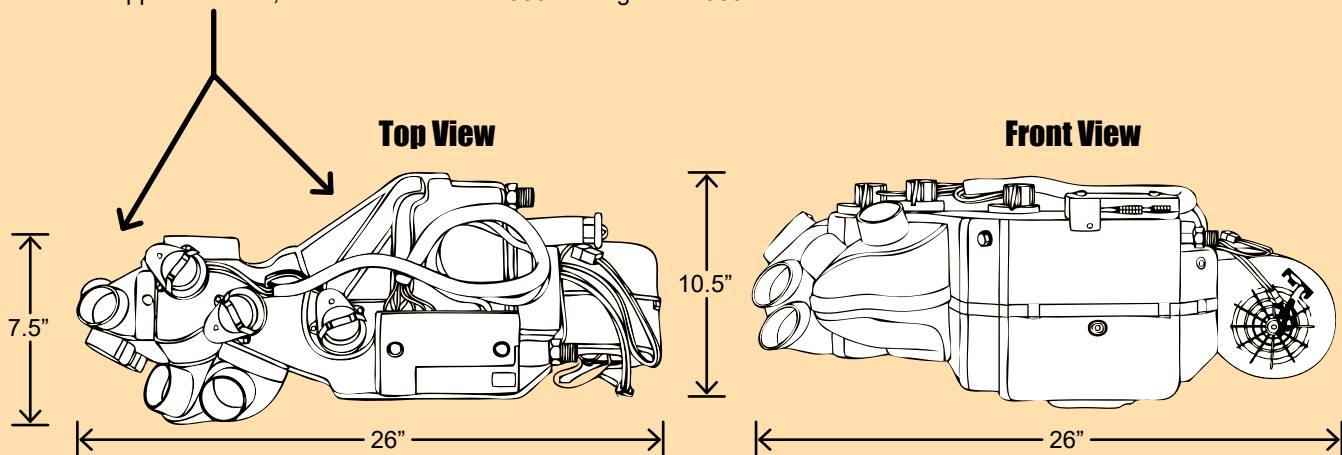

**Please allow 7-14 days for Special Orders!**

Air Conditioner Parts

# 1962-72 Fairlane



Mark IV

Air Conditioner Parts



## Mark IV Systems

Comes complete with:

- Under dash evaporator and mounting brackets
- Built-in controls
- Drain kit

### The real steel Mark IV is back!

Vintage Air has created an exact reproduction of the most popular underdash air conditioner ever made. The Mark IV features an all steel case built from the original tooling. The timeless look of chrome and real steel combined with Vintage Air's proven performance makes the new Mark IV a great choice for your period perfect ride. Includes mounting brackets and drain line.

**Under Dash Cool Only 672001-VHY..... 299.00**

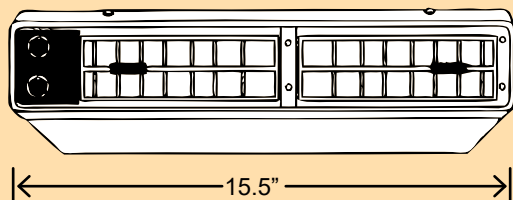
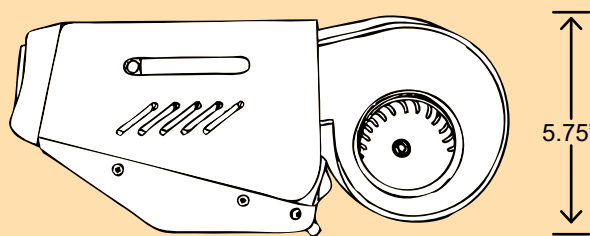
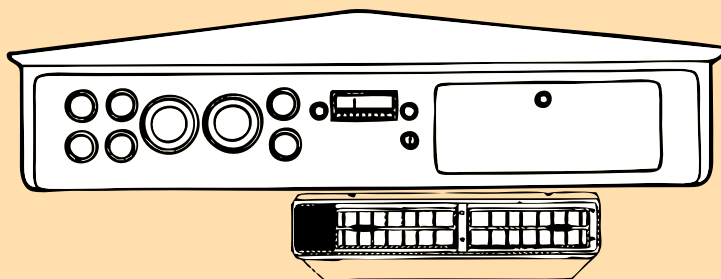
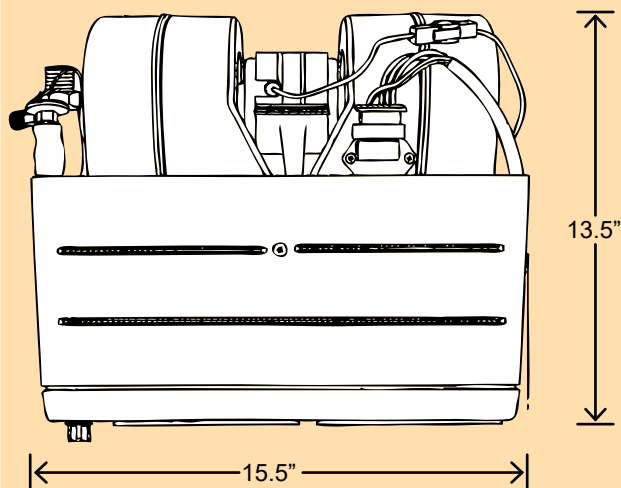

Please allow 7-14 days for Special Orders!

# 1962-72 Fairlane

## The Slim Line System



### The Slim Line System

Comes complete with:

- Under dash evaporator and mounting brackets
- Controls
- Drain kit



This system has been engineered by Vintage Air with a matched blower motor and blower wheel to provide greater cooling capacity and air delivery than any other under dash unit on the market.

Cool only - passenger side fittings

**11301-VUY-A** ..... **315.00**

Heat and cool - passenger side fittings

**11301-VUX-A** ..... **340.00**

Heat, cool and defrost

**11300-VUZ-A** ..... **380.00**

## Mini Slim Line System



### The Slim Line System

Comes complete with:

- Under dash evaporator and mounting brackets
- Controls
- Drain kit

A simple solution to A/C installation. This system has been engineered by Vintage Air with at matched blower motor and blower wheel to provide exceptional cooling capacity and air delivery. Choose driver side or passenger side connections.

Cool only - passenger side fittings

**10301-VUY-A** ..... **310.00**

Heat and cool - passenger side fittings

**10301-VUX-A** ..... **335.00**

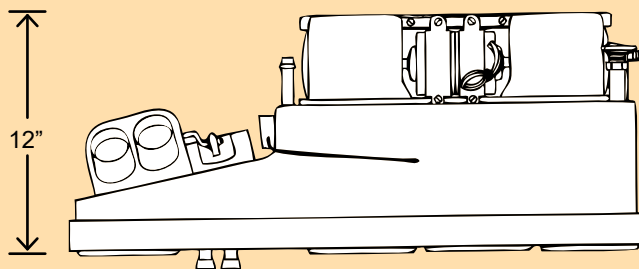

Slim Line Dimension Detail

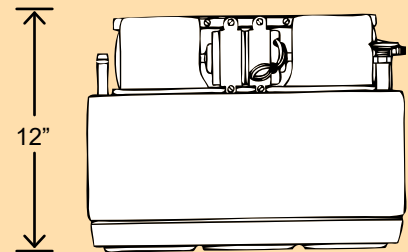

Mini Slim Line Dimension Detail

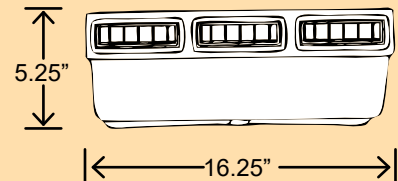
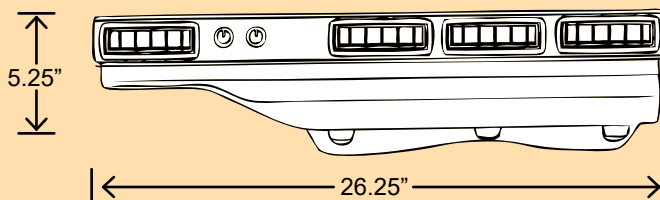

# 1962-72 Fairlane



## Gen-II Controls

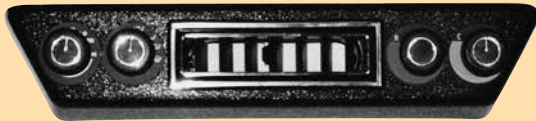

Gen-II 4 knob Underdash pod with louver - for Gen-II systems with servo heater valve  
**49205-RHA each ..... 49.00**



Gen-II 4 knob Underdash Pod - for Gen-II systems with servo heater valve  
**49200-RHA each ..... 45.00**



Gen-II Underdash Pod for 4 lever panel - for Gen-II systems with servo heater valve  
**47211-SHA each ..... 15.95**

These are the pods only! The 4 lever Controls are sold separately.



Gen-II Underdash Pod with louver for 4 lever panel - for Gen-II systems with servo heater valve  
**47210-SHA each ..... 25.00**

## Standard Gen-II Fingertip Control

Only Gen-II delivers true OEM style louver air temperature regulation and bi-level operation of A/C and heat modes! This standard panel uses our exclusive servo actuated heater valve which allows the introduction of small amounts of heat to regulate air temperature. Simplified installation with plug-in connections, no vacuum lines, and fewer wires to route. The face is slightly larger to allow you to upgrade from your existing Proline Panel installation.

4 lever horizontal Fingertip Panel - 4.63" wide x 2.44" tall. Internally lighted  
**49110-SHQ each ..... 45.00**

4 lever vertical Fingertip Panel - 2.44" wide x 4.63" tall. Internally lighted  
**49110-SVQ each ..... 45.00**



## Optional Gen-II Panels



### 4 Knob Streamline Panel

Super compact panel controls all functions of any Gen-II system. Engraved and polished panel face. Internally lighted, polished aluminum knobs.

5.318" wide x 1" tall  
**491200-RUA each ..... 159.00**



### Machined Face

Machined face aluminum control panel in horizontal or vertical design.

Horizontal Panel - 4.69" wide x 2.5" tall. Internally lighted  
**48103-SHQ each ..... 129.00**

Vertical Panel - 2.5" wide x 4.69" tall. Internally lighted  
**48102-SVQ each ..... 129.00**

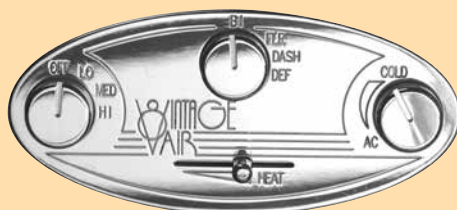

### Streamline

Streamline control panel for Gen-II same styling and dimensions as original Vintage Air design! Engraved and polished panel face. Internally lighted and polished aluminum knobs.

Gen-II Pro Panel - 5.5" wide x 2.5" tall. Back lighted knobs  
**48104-RHQ each ..... 154.00**

# 1962-72 Fairlane



## Compressors

### Compressors

Sanden SD 508 Compressor

This compressor is recommended for all Vintage Air systems. It pumps 8.4 cubic inches per revolution with a maximum 6000 sustained RPM range. Fits all Vintage Air brackets. Available in standard finish or polished.

Double V groove pulley - standard finish

**04808-VUA each** ..... **0.00**

Double V groove pulley - polished finished

**04808-VUQ each** ..... **249.00**

7-groove serpentine pulley - standard finish

**04808-VMA each** ..... **199.00**

7-groove serpentine pulley - polished finish

**04808-VMQ each** ..... **249.00**

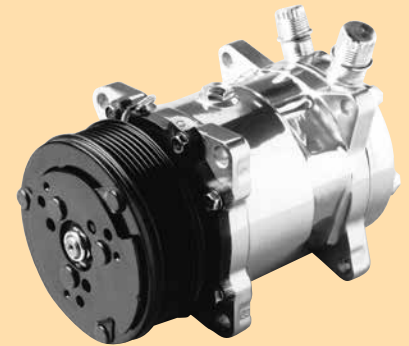

## Proline System Accessories



### Chrome Drier

Features a built in counting bracket and compact size. 2.5" x 6"

Chrome drier with bracket

**07310-VUQ each** ..... **0.00**



### Standard Drier

Economy choice, painted black. 2.5" x 6"

**07321-VUC each** ..... **21.00**

### Brackets

260 V8 and pre 1969 289 V8 compressor

**15110-VFB each** ..... **99.00**

289, 302, 351 Windsor driver side compressor only bracket

**131105 each** ..... **99.00**

332, 352, 360, 390, 406, 410, 427, 428 FE V8 compressor bracket

**131005 each** ..... **109.00**

460 V8 1975-80 with or without power steering and air pump

**15118-VFB each** ..... **535.00**

## Aluminum Bulkhead Plates

Creates professional looking installation and allows one-man tightening of fittings and reduce the possibility of scratching your paint.



### Machined Billet Plates

4-Way for A/C and Heater O-Ring Lines - 3" x 3.187"

8-10 male o-ring

**34017-VUQ each** ..... **99.00**

2-Way for Air Conditioning O-Ring Lines - 1.5" x 3.187"

2-way A/C radiator - 6-8 male o-ring

**34014-VUQ each** ..... **69.00**

2-way A/C firewall - 6-10 male o-ring

**34215-VUQ each** ..... **69.00**

2-way A/C firewall - 8-10 male o-ring

**34015-VUQ each** ..... **69.00**



2-Way for Heater O-Ring Lines - 1.5" x 3.187"

2-way heater - 10-10 male o-ring

**34116-VUQ each** ..... **69.00**

4-Way In-line for A/C and Heater O-Ring Lines - 1.5" x 6.5"

A/C and heater - 6-10 male o-ring

**34317-VUQ each** ..... **99.00**



### Streamline Plates

Lower profile, easier installation - just drill 4 individual holes

4-Way Diamond for A/C and Heater - 2.75" x 4.375"

6-10 male o-ring

**388600-MBA each** ..... **65.00**

8-10 male o-ring

**388800-MBA each** ..... **65.00**



2-Way for A/C and heater O-Ring - 1.25" x 2.75"

2-way A/C - 6-10 male o-ring

**382600-MBA each** ..... **41.00**

2-way A/C - 8-10 male o-ring

**382800-MBA each** ..... **41.00**

2-way A/C - 6-8 male o-ring

**382680-MBA each** ..... **41.00**

2-way heater - 10-10 male o-ring

**382000-MBA each** ..... **41.00**

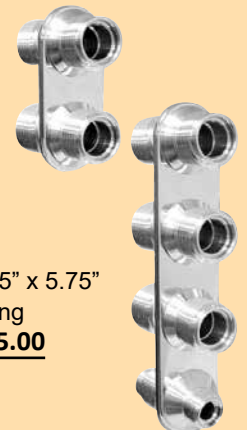

4-Way In-line for A/C and Heater - 1.25" x 5.75"

4-way A/C and heater - 6-10 male o-ring

**386600-MBA each** ..... **65.00**

# 1962-72 Fairlane



## Refrigerant and Heater Hose

Air Conditioner Parts

### Barrier Type Refrigerant Hose

All Vintage Air line kits use barrier type refrigerant line for use with HFC-134a refrigerants. Includes fittings with service ports, adequate hose length to connect complete system, all o-ring fittings and crimp ferrules. Includes 6 ft. of #6, 4 ft. of #8, and 5 ft. of #10 barrier hose.



Hose kit with drier and barb fitting	<b>31700-VUD each</b> .....	<b>109.00</b>
Hose kit with drier and beadlock fitting	<b>31700-VBD each</b> .....	<b>109.00</b>
Hose kit without drier and barb fitting	<b>31702-VUD each</b> .....	<b>105.00</b>
Hose kit without drier and beadlock fitting	<b>31703-VBD each</b> .....	<b>105.00</b>



### Standard Heater Hose Kits

Choose straight or 90° firewall bulkhead fittings. Includes: 1 ft. of 5/8" heater hose, 2 standard male o-ring 90° bulkhead fittings (or 2 standard straight bulkhead fittings), 2 female o-ring 90° fittings and 8 hose clamps.

90° bulkhead fitting heater hose kit	<b>31400-VUD each</b> .....	<b>49.00</b>
Straight bulkhead fitting heater hose kit	<b>31401-VUD each</b> .....	<b>49.00</b>

## SuperFlow Condenser

### Horizontal SuperFlow™ Condenser

This new SuperFlow™ condenser design has once again demonstrated Vintage Air's commitment to leading edge technology and superior product quality. The importance of this unique new micro tube design and its improved refrigerant flow cannot be over emphasized. By providing increased refrigerant contact with the micro tube walls and multiple passes per circuit for low restriction pathway, the SuperFlow™ condenser provides up to 40% more capacity than a comparably sized tube and fin condenser.

Perfect for late model cars with more grill area. With male o-ring fittings. Top #8. Bottom #6. All condensers include universal mount bracket kit.

Condenser with brackets 12" tall x 20" wide x .83" thick	<b>03701-OVA each</b> .....	<b>117.00</b>
Condenser with brackets 12" tall x 24" wide x .83" thick	<b>03704-OVA each</b> .....	<b>0.00</b>
Condenser with brackets 14" tall x 18" wide x .83" thick	<b>03260-VUC each</b> .....	<b>0.00</b>
Condenser with brackets 14" tall x 20" wide x .83" thick	<b>03261-VUC each</b> .....	<b>0.00</b>
Condenser with brackets 14" tall x 22" wide x .83" thick	<b>03262-VUC each</b> .....	<b>0.00</b>
Condenser with brackets 14" tall x 24" wide x .83" thick	<b>03263-VUC each</b> .....	<b>0.00</b>

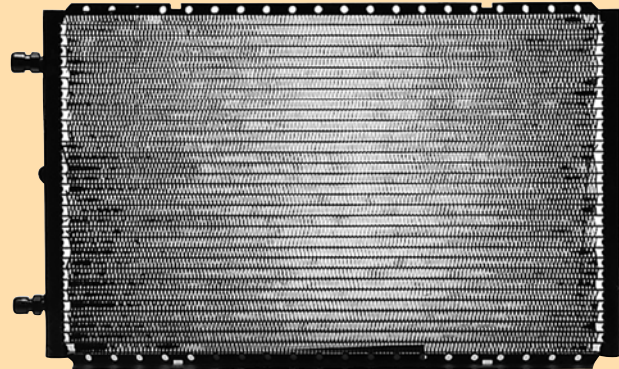

## Safety Switches

### Trinary Switch Kit

Low pressure and high pressure compressor clutch cut off functions PLUS electric fan engagement signal at 220 psi. 30 psi low pressure cut off. 380 psi high pressure cut off. Recommended for all electric fan installations.

Trinary switch kit for barb crimp	<b>24676-VUS each</b> .....	<b>51.00</b>
Trinary switch kit for beadlock crimp	<b>24678-VUS each</b> .....	<b>51.00</b>

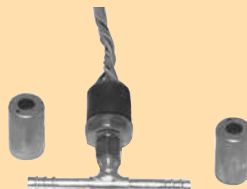

### Binary Switch Kit

Combines high and low pressure functions into one switch. 30 psi low pressure cutoff, 380 lb. high pressure cutoff.

Binary switch kit for barb crimp	<b>24677-VUS each</b> .....	<b>35.00</b>
Binary switch for beadlock crimp	<b>24679-VUS each</b> .....	<b>35.00</b>

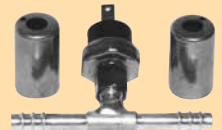

# 1962-72 Fairlane

## Electric Cooling Fans



Air Conditioner Parts



Skewed Blade

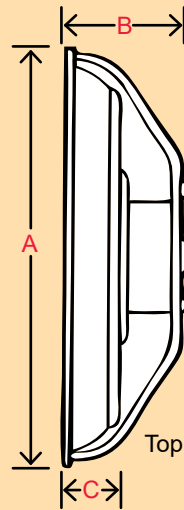
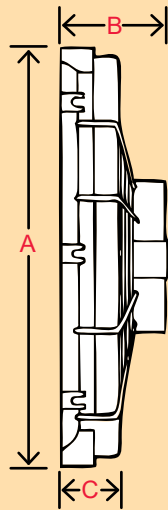

Top View

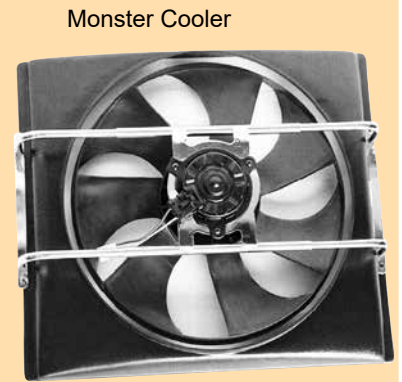

Monster Cooler

### 18" MonsterCooler™ Electric Fan

This is the most powerful electric fan available! Designed to cool Vintage Air's "A Cool 200" Studebaker and will handle up to 950 horse power. Steel bracket can be mounted in horizontal or vertical position. Durable enough for off-road vehicles and powerful enough for the hottest hot rod! Comes complete with adjustable tubular bracket, wiring harness, adjustable thermostat, electric relays and circuit breaker. Chromed or black painted bracket finish.

Part Number	'A' measurement	'B' measurement	'C' measurement	CFM	Price
32018-VUF	19.75 - 28"	2.125	1.375	3700+	305.00
32018-VUQ - chrome steel bracket	19.75 - 28"	2.125	1.375	3700+	325.00

### Skewed Blade Electric Fans

Reversible high volume skewed blade fans deliver maximum cooling efficiency.

Part Number	'A' measurement	'B' measurement	'C' measurement	CFM	Price
32610-VUF	11.20"	2.480	1.20	950	79.00
32612-VUF	13.23"	2.480	1.20	1155	85.00
32614-VUF	15.04"	2.870	1.20	1555	92.00
32616-VUF	16.30"	2.870	1.20	1810	102.00
32716-VUF - heavy duty unit	16.30" HD	3.190	1.20	2170	130.00

## Parts and Accessories



### Electric Fan Thermostat Kit with Wiring

Includes thermostat, adapter bushings, and wiring harness.

190° switch kit

**24190-VUT each . . . . . 69.95**

205° switch kit

**24205-VUT each . . . . . 69.95**

# 1962-72 Fairlane



## Firewall Insulator Kit

A heavy duty, quality reproduction. Heavy rubber backing with a felt insulation pad. All holes cut and complete with mounting clips.

- 1962-64 Fairlane  
(Stock # BB1-31535-115) **(A)**  
OEM # C2OZ-01670-62A kit ..... 49.95
- 1965-67 Fairlane  
(Stock # BB1-31535-135) **(B)**  
OEM # C5OZ-01670-62A kit ..... 39.95



## ABS Firewall Insulator Kit

ABS plastic with a medium embossed leather grain. It is very tough, but flexible, and does not show scratches or scuffs. Can be easily dyed.

- 1962-64 Fairlane  
(Stock # BB1-31535-116) **(A)**  
OEM # C2OZ-01670-62ABS kit ..... 213.95
- 1965-67 Fairlane  
(Stock # BB1-31535-137)  
OEM # C5OZ-01670-62ABS kit ..... 213.95
- 1968-69 Fairlane and Torino  
(Stock # BB1-31535-190)  
OEM # C8OZ-01670-65ABS kit ..... 227.95
- 1970-71 Fairlane and Torino  
(Stock # BB1-31535-300)  
OEM # D0OZ-01670-65ABS kit ..... 227.95



## Firewall Insulation Retainer

1968-72 Fairlane and Torino  
1968 Comet and Montego  
(Stock # PB1-31540)

OEM # C8ZZ-01691-65A each . . . . 1.95



## Firewall Cover Clip

Metal with alligator teeth. Fastens the firewall cover to the firewall.

1962-72 Fairlane  
(Stock # VB1-31535-005)

OEM # 48-7001670-CLIP each . . . 2.95



## Air Vent Inlet Duct to Cowl Gaskets

1962-64 Fairlane  
1962-63 Meteor  
(Stock # BB1-31675)

OEM # C2OZ-01999-62A pair . . . . 1.95

1966-69 Fairlane - with heater  
(Stock # BB1-31675-005)

OEM # C6OZ-01999-62A pair . . . 14.95

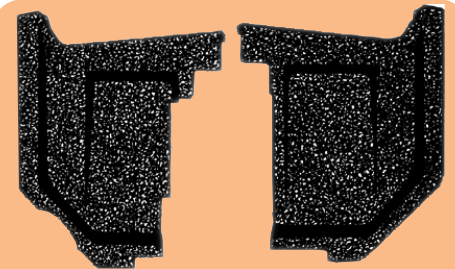

## Cowl Kick Panels

High quality reproduction available in black only. Dye to match. Double injected ABS plastic. Original fit and finish.

1962-65 Fairlane **Price Reduced!**  
(Stock # BB2-32220-045)

OEM # C2OZ-02344/5-62A pair . . 0.00  
1966-67 Fairlane/Ranchero/Comet

(Stock # BB2-32220-055) **Price Reduced!**  
OEM # C7OZ-02344/5-62 pair . . 69.95

1968-69 Fairlane, Torino and Ranchero  
1968-69 Comet and Montego **Price Reduced!**

(Stock # BB2-32220-060)  
OEM # C8OZ-02344/5-54 pair . . 69.95

1970-71 Torino/Ranchero/Comet/Montego  
(Stock # BB2-32220-065) **Price Reduced!**

OEM # D0OZ-02344/5-65 pair . . 69.95

1972 Torino/Ranchero **Price Reduced!**  
(Stock # BB2-32220-070)

OEM # D2OZ-02344/5-65 pair . . 69.95



## Cowl Kick Panel Insulation

Fits behind your replacement cowl kick panels.

1968-73 Torino  
(Stock # BB2-32220-061)

OEM # C8OZ-02344/5-65KPI set. . 0.00



## Cowl Top Vent Seals

Injection moulded black plastic with look and fit of original.

1970-71 Torino, Ranchero, Montego and Cyclone

(Stock # BB1-31565)

OEM # D0OZ-018A16/7-65A pair . . . . 0.00

The competitor to be feared is one who never bothers about you at all, but goes on making his own business better all the time. ~ Henry Ford



Friend us on Facebook and follow us on Twitter. You never know what you might be in for.

# 1962-72 Fairlane

Miscellaneous Interior Parts

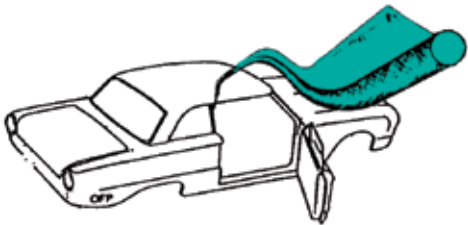

### Available Colors

### Antique Cloth Style Windlace

Round, 1/2" sponge filled core - sold per foot

- (Stock # PB2-32295-070) - black
- OEM # WL-02600-70A foot . . . . . 3.95**
- (Stock # PB2-32295-075) - gray
- OEM # WL-02600-70B foot . . . . . 3.95**
- (Stock # PB2-32295-080) - tan
- OEM # WL-02600-70C foot . . . . . 3.95**
- (Stock # PB2-32295-085) - brown
- OEM # WL-02600-70D foot . . . . . 3.95**
- (Stock # PB2-32295-090) - dark blue
- OEM # WL-02600-70E foot . . . . . 3.95**
- (Stock # PB2-32295-095) - Ford® blue
- OEM # WL-02600-70F foot . . . . . 3.95**
- (Stock # PB2-32295-100) - red
- OEM # WL-02600-70G foot . . . . . 3.95**
- (Stock # PB2-32295-105) - white
- OEM # WL-02600-70H foot . . . . . 3.95**
- (Stock # PB2-32295-110) - dark green
- OEM # WL-02600-70J foot . . . . . 3.95**
- (Stock # PB2-32295-115) - maroon
- OEM # WL-02600-70K foot . . . . . 3.95**
- (Stock # PB2-32295-120) - dark brown
- OEM # WL-02600-70L foot . . . . . 3.95**
- (Stock # PB2-32295-125) - antique brown
- OEM # WL-02600-70N foot . . . . . 3.95**
- (Stock # PB2-32295-130) - aqua blue
- OEM # WL-02600-70O foot . . . . . 5.95**

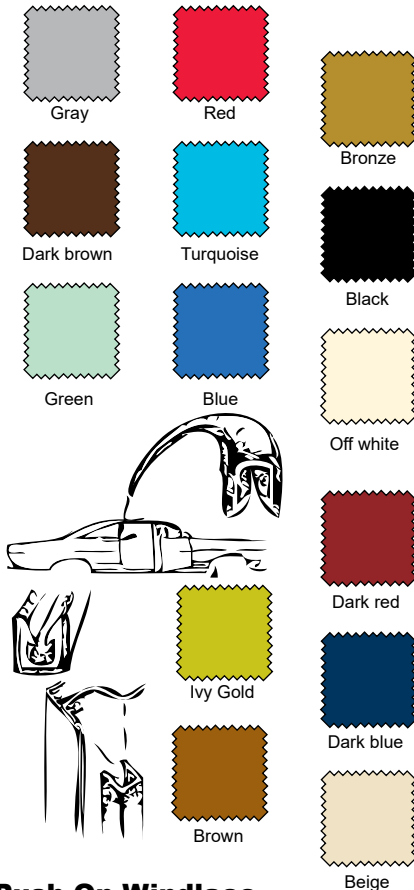

### Push On Windlace

All plastic push on style with metal core. Sold in 15 foot roll.

- (Stock # PB2-32295-005) - gray
- OEM # COAZ-02600-70AS roll . . . . . 1.95**
- (Stock # PB2-32295-010) - red
- OEM # COAZ-02600-70BS roll . . . . . 1.95**
- (Stock # PB2-32295-015) - bronze
- OEM # COAZ-02600-70CS roll . . . . . 0.00**
- (Stock # PB2-32295-020) - dark brown
- OEM # COAZ-02600-70DS roll . . . . . 0.00**
- (Stock # PB2-32295-025) - turquoise
- OEM # COAZ-02600-70ES roll . . . . . 1.95**
- (Stock # PB2-32295-030) - black
- OEM # COAZ-02600-70FS roll . . . . . 1.95**
- (Stock # PB2-32295-035) - green
- OEM # COAZ-02600-70GS roll . . . . . 1.95**
- (Stock # PB2-32295-040) - blue
- OEM # COAZ-02600-70HS roll . . . . . 1.95**
- (Stock # PB2-32295-045) - off white
- OEM # COAZ-02600-70IS roll . . . . . 1.95**
- (Stock # PB2-32295-050) - brown
- OEM # COAZ-02600-70JS roll . . . . . 0.00**
- (Stock # PB2-32295-055) - dark blue
- OEM # COAZ-02600-70KS roll . . . . . 1.95**
- (Stock # PB2-32295-060) - dark red
- OEM # COAZ-02600-70LS roll . . . . . 1.95**
- (Stock # PB2-32295-065) - beige
- OEM # COAZ-02600-70MS roll . . . . . 1.95**
- (Stock # PB2-32295-067) - ivy gold
- OEM # COAZ-02600-70NS roll . . . . . 1.95**
- (Stock # PB2-32295-068) - white
- OEM # COAZ-02600-70PS roll . . . . . 1.95**

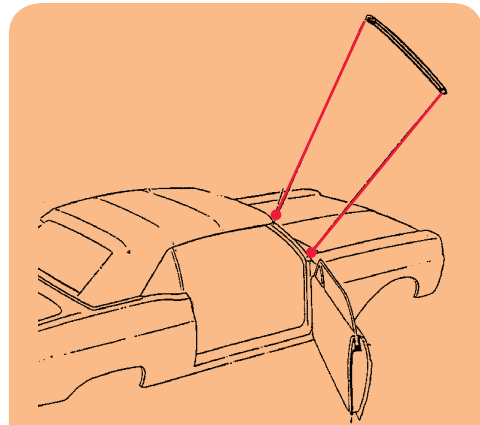

### Windshield Post to Door Seals

- 1966-67 Fairlane/Comet - Convertible  
(Stock # BB2-32300-090)
- OEM # C6OZ-02626/7-76 pair . . . 95.95**
- 1968-69 Fairlane - Convertible  
(Stock # BB2-32300-105)
- OEM # C8OZ-02626/7-76 pair . . . 71.95**



### Pillar Post Moldings

Original simulated stitch and Corinthian grain texture. Black can dye to match interior.

- 1967 Fairlane and Rancho
- (Stock # BB3-33175-015) - black (A) Price Reduced!
- OEM # C7OZ-03598/9-62A pair . . . . . 59.95**
- (Stock # BB3-33175-017) - blue New!
- OEM # C7OZ-03598/9-62B pair . . . . . 59.95**
- (Stock # BB3-33175-019) - red New!
- OEM # C7OZ-03598/9-62C pair . . . . . 59.95**
- 1972-79 Torino and Rancho
- (Stock # BB3-33175-030) (B)
- OEM # D3OZ-03598/9-65A pair . . . . 119.95**

**1-800-654-3247**

**Call Us for  
All-American  
Deals**

# 1962-72 Fairlane



**Special ORDER**

### Windshield Glass

Direct replacement windshields. Available colors: Clear - Green Tint or Green Tint with Blue Shaded Top (shown above). Specify color when ordering.

**NOTE: These are crated and shipped Motor freight. Residential Delivery Freight \$150 and Commercial Delivery Freight \$100.**

- 1962-65 Fairlane - Sedan and 4 door Station Wagon  
(Stock # BB3-33020-345)  
**OEM # C2OZ-03100-62 each . . . . . 419.95**
- 1963-65 Fairlane - 2 door Hardtop  
1963 Mercury® Meteor - 2 door Hardtop  
(Stock #BB3-33020-365)  
**OEM # C3OZ-03100-63 each . . . . . 429.95**

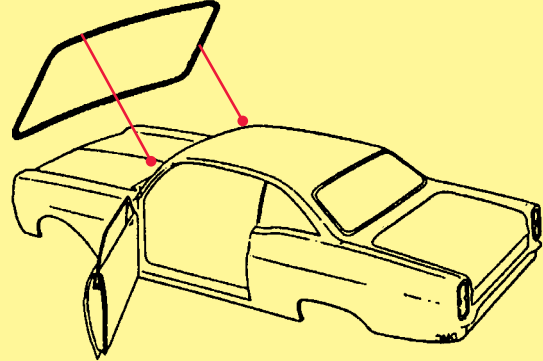

### Windshield Rubber

- 1962-65 Fairlane - except 2 door Hardtop  
1962-63 Meteor - except 2 door Hardtop  
(Stock # BB3-33025-220)  
**OEM # C2OZ-03110-62A each . . . . . 94.95**
- 1963-65 Fairlane - 2 door Hardtop  
1963 Meteor - 2 door Hardtop  
(Stock # BB3-33025-235)  
**OEM # C3OZ-03110-65A each . . . . . 89.95**

**Please allow 7-14 days for Special Orders!**



### Grey Sun Visor

Dye to match interior color.  
1965 Fairlane - except Hardtop  
(Stock # BB4-34035-140)

**OEM # C5OZ-04144-62G each . . 35.95**



### Interior Sun Visors

- Correct Sierra grain vinyl.  
1966-67 Fairlane/Comet - Convertible  
(Stock # BB4-34005-155) - **black**  
**OEM # C6OZ-04104-76A1A pair . . . . . 97.95**  
(Stock # BB4-34005-165) - **medium blue**  
**OEM # C6OZ-04104-76AAC pair . . . . . 81.95**  
(Stock # BB4-34005-160) - **parchment**  
**OEM # C6OZ-04104-76A1U pair . . . . . 99.95**  
(Stock # BB4-34005-170) - **aqua**  
**OEM # C6OZ-04104-76BAF pair . . . . . 97.95**  
(Stock # BB4-34005-175) - **red**  
**OEM # C6OZ-04104-76BAK pair . . . . . 97.95**



### Interior Sun Visors

- Original grain vinyl.  
1967 Fairlane/Comet - except Convertible  
(Stock # BB4-34005-185) - **black**  
**OEM # C7OZ-04104-62A1A pair . . . . . 0.00**  
(Stock # BB4-34005-190) - **light blue**  
**OEM # C7OZ-04104-62A1B pair . . . . . 97.95**  
(Stock # BB4-34005-195) - **red**  
**OEM # C7OZ-04104-62A1D pair . . . . . 83.95**  
(Stock # BB4-34005-200) - **light aqua**  
**OEM # C7OZ-04104-62A1K pair . . . . . 97.95**  
(Stock # BB4-34005-205) - **parchment**  
**OEM # C7OZ-04104-62A1U pair . . . . . 97.95**

### Interior Sun Visors

- Original grain material with stamped steel interior inserts for durability and fit.  
1966 Fairlane/Ranchero/Comet - All except Convertible  
(Stock # BB4-34005-130) - **black**  
**C6OZ-04104-62BAJ pair . . . . . 119.95**  
(Stock # BB4-34005-135) - **red**  
**C6OZ-04104-62BAK pair . . . . . 97.95**  
(Stock # BB4-34005-140) - **white**  
**C6OZ-04104-62CAB pair . . . . . 97.95**  
(Stock # BB4-34005-145) - **light blue**  
**C6OZ-04104-62CAC pair . . . . . 97.95**  
(Stock # BB4-34005-150) - **light aqua**  
**C6OZ-04104-62CAF pair . . . . . 97.95**



# 1962-72 Fairlane

Miscellaneous Interior Parts



## Interior Sun Visors

Correct grain vinyl with steel interior insert for stability and correct rod fit.

1968-69 Torino and Ranchero - except Convertible

(Stock # BB4-34005-215) - **black**

**OEM # C8OZ-04104-62E1A pair . . . 109.95**

(Stock # BB4-34005-220) - **parchment**

**OEM # C8OZ-04104-62E1U pair . . . 97.95**

(Stock # BB4-34005-225) - **red**

**OEM # C8OZ-04104-62E2D pair . . . 97.95**

(Stock # BB4-34005-255) - **dark aqua**

**OEM # C9OZ-04104-54C1K pair . . . 97.95**



## Interior Sun Visors

Correct Sierra grain vinyl with metal insert for stability and rod alignment.

1968-69 Torino - Convertible

(Stock # BB4-34005-230) - **black**

**OEM # C8OZ-04104-76C2A pair . . . 97.95**

(Stock # BB4-34005-235) - **blue**

**OEM # C8OZ-04104-76D2B pair . . . 83.95**

(Stock # BB4-34005-240) - **red**

**OEM # C8OZ-04104-72D2D pair . . . 99.95**

(Stock # BB4-34005-245) - **aqua**

**OEM # C8OZ-04104-76D2K pair . . . 97.95**

(Stock # BB4-34005-250) - **parchment**

**OEM # C8OZ-04104-76D2U pair . . . 97.95**

**We accept these MAJOR credit cards.**



## Interior Sun Visors

Correct grain vinyl with steel insert for stability and correct rod alignment.

1970-71 Torino - except Convertible

(Stock # BB4-34005-300) - **black**

**OEM # D0OZ-04104-54B pair . . . 97.95**

(Stock # BB4-34005-305) - **blue**

**OEM # D0OZ-04104-54C pair . . . 97.95**

(Stock # BB4-34005-310) - **ginger**

**OEM # D0OZ-04104-54F pair . . . 97.95**

(Stock # BB4-34005-315) - **maroon**

**OEM # D0OZ-04104-54G pair . . . 97.95**



## Interior Sun Visors

Correct Sierra grain vinyl.

1970-71 Torino - Convertible

(Stock # BB4-34005-330) - **black**

**OEM # D0OZ-04104-76C pair . . . 97.95**

(Stock # BB4-34005-320) - **ginger**

**OEM # D0OZ-04104-76A pair . . . 97.95**

(Stock # BB4-34005-325) - **blue**

**OEM # D0OZ-04104-76B pair . . . 83.95**

(Stock # BB4-34005-335) - **white**

**OEM # D0OZ-04104-76E pair . . . 97.95**



## Interior Sun Visors

Correct grain vinyl.

1972 Torino

(Stock # BB4-34005-385) - **black**

**D2OZ-04104-65A pair . . . 97.95**

(Stock # BB4-34005-390) - **dark blue**

**D2OZ-04104-65B pair . . . 97.95**

(Stock # BB4-34005-395) - **white**

**D2OZ-04104-65D pair . . . 97.95**

(Stock # BB4-34005-400) - **ginger**

**D2OZ-04104-65E pair . . . 97.95**



## Interior Sun Visor Anchor Pin

Requires one per visor

1962-69 Fairlane

1965-68 Comet

(Stock # XB4-34010-005)

**OEM # C3DZ-04114-76B each . . . 4.95**



## Interior Sun Visor Pin and Tip

Paint to match.

1970-72 Torino and Ranchero

(Stock # PB4-34010-015)

**OEM # D3AZ-04114-65B each . . . 3.95**

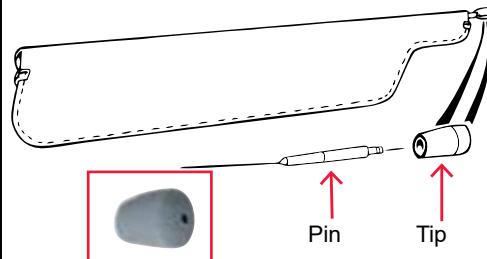

## Interior Sun Visor Anchor Pin Sleeve (Rubber Tip)

1962-72 Fairlane and Torino

1962-63 Meteor

1966-70 Comet and Montego

(Stock # PB4-34015)

**OEM # C5AZ-04115-62A each . . . 0.95**



## Sun Visor Arm Clip

Fits between the visors. What the rubber tip snaps into.

1968-70 Fairlane and Torino

(Stock # PB4-34025-015) - **black**

**OEM # C8ZZ-04132-65BLK each . . . 16.95**

(Stock # PB4-34025-020) - **white**

**OEM # C8ZZ-04132-65WHT each . . . 17.95**



Classic Auto Parts has been serving your car and truck needs since 1974!

We appreciate our customers!

# 1962-72 Fairlane



## Sun Visor Bracket and Arm Assembly

1962-65 Fairlane - except 2 door Hardtop

**Plain steel - Paint to Match**

(Stock # XB4-34035-080) - right hand

**OEM # C0DB-04144-64A each . . . . .41.95**

(Stock # XB4-34040-040) - left hand

**OEM # C0DB-04145-64A each . . . . .41.95**

**Chrome Plated**

(Stock # XB4-34035-082) - right hand **Price Reduced!**

**OEM # C0DB-04144-64CC each . . . . .29.95**

(Stock # XB4-34040-042) - left hand **Price Reduced!**

**OEM # C0DB-04145-64CC each . . . . .29.95**

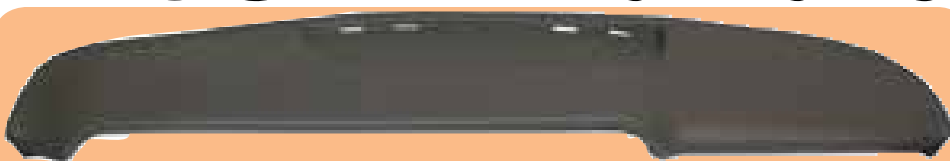

## Black Padded Dash

This Concours reproduction features correct crush grain vinyl formed to the original specifications with original foam backing. We went to great lengths to insure a perfect fit and the original appearance. This part fits all Fairlane models 1962 through 1965 and is available in black OEM vinyl but can be dyed to match your original color. This is the complete pad manufactured in the USA.

1962-65 Fairlane and 1962-63 Mercury® Meteor

(Stock # BB4-34050-152)

**OEM # C2OZ-04290-65A each . . . . .578.95**

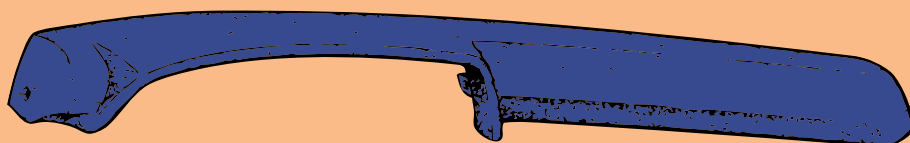

## Blue Padded Dash

1972-79 Ranchero

1972-76 Torino

(Stock # MB4-34045-025)

**OEM # D2GZ-04282-65A each . . . . .299.95**



## Black Dash Cap

This dash cap snaps over existing dash to give an original look at a lower cost than replacing the entire dash assembly, which is currently not in production. This is black and can be dyed to match your original interior color.

1972 Torino, Gran Torino and Ranchero

(Stock # BB4-34045-035)

**OEM # D2OZ-04282-65DC each . . . . .112.95**



## Sun Visor Arm and Bracket

Triple chrome plated. Fits either side.

1966 Fairlane - except Convertible

(Stock # BB4-34035-145)

**OEM # C6OZ-04144-54A each . . . . .54.95**



## Dash Insert Bezel

This is the chrome bezel that the dash insert mounts into. It mounts into a rectangular slot on all 1970-71 dash pads. Made of injection plastic, vacuum metallized chrome as original. Insert sold separately.

1970-71 Fairlane and Torino

(Stock # BB4-34090-020) **Price Reduced!**

**OEM # D0OZ-04338-65A each . . . . .35.95**



## Glove Box Emblem Insert

Beautiful reproduction of the glove box emblem. Features silver and black color pattern as original. Made in the U.S.A.!

1966-67 Comet Cyclone GT

(Stock # XB4-34165-016)

**OEM # C6GY-04460-62GT each . . . . .26.95**

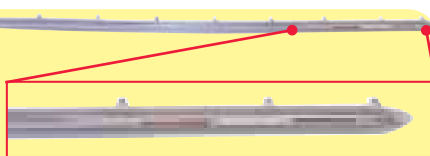

## Dash Plastic Molding

Inset molding on the passenger side. Chrome plated plastic with red, white and blue paint detailing. Includes retainers.

1968-69 Torino

(Stock # BB4-34165-030) - 21 1/4" long

**OEM # C9OZ-04460-54A each . . 83.95**



## Cobra Dash Emblem Insert

Replace you old dash emblem insert with our brand new high quality reproduction. Manufactured of embossed aluminum with correct paint colors. Adhesive backed for easy installation.

1970-71 Torino Cobra

(Stock # BB4-34165-035)

**OEM # D0OZ-04460-65C each . . 11.95**



## Dash Emblem Insert

Replace you old dash emblem insert with our brand new high quality reproduction. Manufactured of embossed aluminum with correct paint colors. Adhesive backed for easy installation.

1970-71 Torino GT

(Stock # BB4-34165-040)

**OEM # D0OZ-04460-65D each . . 11.95**



## Dash Emblem Insert

Replace you old dash emblem insert with our brand new high quality reproduction. Manufactured of embossed aluminum with correct paint colors. Adhesive backed for easy installation.

1970-71 Ranchero

(Stock # BB4-34165-045)

**OEM # D0OZ-04460-66A each . . 13.95**

*Check our prices on-line!  
See our website for current pricing.*



Miscellaneous Interior Parts

# 1962-72 Fairlane

Miscellaneous Interior Parts

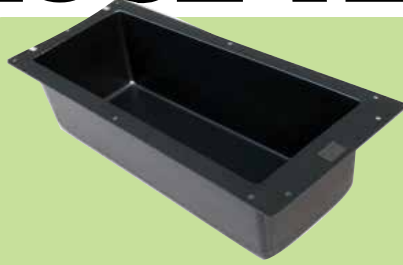

## Console Box Liner

These are molded ABS plastic with the correct grain texture and durability that will outlast the fragile originals. Available in black. Made in the USA!

1963-65 Fairlane - with console  
(Stock # BB5-35005-145)

Price  
Reduced!

**OEM # C3OZ-06010-65A each . . 87.95**



## Glove Box Liner

Original style cardboard liner.

1962-65 Fairlane

1962-63 Meteor

(Stock # BB5-35005-135)

**OEM # C2OZ-06010-62A each . . 19.95**

1966-67 Fairlane

(Stock # BB5-35005-165)

**OEM # C6OZ-06010-62A each . . 22.95**

1966-67 Comet

(Stock # MB5-35005-160)

**OEM # C6GY-06010-62C each . . 22.95**

1972 Torino and Ranchero

(Stock # BB5-35005-205)

**OEM # D2OZ-06010-65A each . . 22.95**



## ABS Plastic Glove Box Liner

1968-69 Torino and Ranchero

(Stock # BB5-35005-185)

**OEM # C8OZ-06010-65A each . 144.95**

1970-71 Torino and Ranchero

(Stock # BB5-35005-195)

Price  
Reduced!

Price  
Reduced!

**OEM # D0OZ-06010-65A each . . 55.95**



## Glove Box Door Bumpers

1962-65 Fairlane

(Stock # P16-24565)

**OEM # 0A-16378 pair . . . . . 1.95**

1966-68 Fairlane - also used on fuel door

(Stock # BC3-76575-010)

**OEM # C6OZ-380239-S pair . . . . . 1.95**



## Glove Box Button Bezel

Stainless steel

1966-71 Fairlane

(Stock # BB5-35007-100)

**OEM # C6OZ-060A12-62A each . . 9.95**

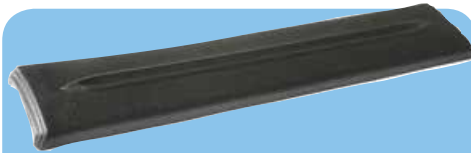

## Center Console Padded Lid

Original console pad fits all 1968/69 Torinos, Rancheros, and Montegos. This exact reproduction features original spear design and correct grain texture, must use original hinge.

1968-69 Torino/Ranchero/Montego

(Stock # BB5-35015-010)

**OEM # C8OZ-06024-65A each . . 83.95**

**OEM # C8OZ-06024-65A each . . 83.95**



## Console Body

This part looks like original and features original Corinthian grain texture and stitch design on top rails. Stronger than original plastic which is prone to cracking, this part is made of hand laid fiberglass and is designed to replace your original. This is the console body only, you will need your original shifter plate, upper tray and console lid to attach to this new body or you can buy a new lid from us (see above). Manufactured in white, must be dyed to match. "These are a suitable fiberglass replacement but not a perfect part, hand laid fiberglass has some surface imperfections. Made in the USA!

1968-69 Fairlane/Torino/Montego/Ranchero

(Stock # BB4-34195-010)

**OEM # C8OZ-045A36-65B each . . . . .785.00**



## Glove Box Door Spring

1966-67 Comet

1968-69 Fairlane

1969 Comet and Montego

(Stock # PB5-35045)

**OEM # C6AZ-06069-62A each . . . 2.95**

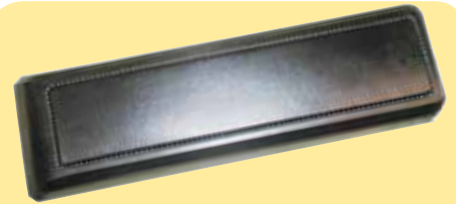

## Center Console Padded Lid

Original console pad fits all 1972/73 Torinos, Rancheros, and Montegos.

This exact reproduction features original design and correct grain texture with soft padded feel.

1972-73 Torino/Ranchero/Montego

(Stock # BB5-35015-020) - blue

Price  
Reduced!

**OEM # D2OZ-06024-65B each . . 83.95**

(Stock # BB5-35015-015) - black

Price  
Reduced!

**OEM # D2OZ-06024-65A each . . 83.95**

Please allow  
7-14 days for  
Special Orders!

Special  
ORDER



## Humphugger Console

Two standard size drink holders. Fits onto carpeted transmission hump. Storage compartment with flip open lid.

1961-71 Cyclone - 1960-77 Comet -

1962-70 Fairlane/Torino - 1962-63 Meteor

- 1966-79 Ranchero - all with bucket seats

Available in all original interior colors

Stock # PB4-34195-050

**OEM # C5Z2-045H36-65BLK . . . . .172.95**



# 1962-72 Fairlane



## Non-Locking Glove Box Door Latch

1967 Ranchero and Station Wagon  
(Stock # XB5-35050-005)  
**OEM # C6DZ-06072-62B each . . . 19.95**

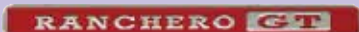

## Ranchero GT Dash Emblem

This is the small stamped aluminum emblem located above your glove box on 1972/1976 Rancheros. They are painted and stamped exactly as original.

1972 Ranchero GT  
(Stock # BB5-35085)  
**OEM # D2OZ-061A14-65A each . 11.95**



## Glove Box Door Check Arm Stop Bumper

1962-63 Fairlane  
(Stock # PB5-35095-010)  
**OEM # B7A-06122-70 each . . . . . 2.95**



## Console Compartment Door Catch

1963-64 Fairlane  
(Stock # PB5-35112-200)  
**OEM # C2AZ-06157-76B each . . . 3.95**



## Rear Frame Rails

Die stamped steel - sold per side  
1966-71 Fairlane/Torino - except Ranchero and Station Wagon  
(Stock # B10-17161-055) - *right hand*  
**OEM # C8OZ-10124-54A each . . . . . 69.95**  
(Stock # B10-17167-075) - *left hand*  
**OEM # C8OZ-10125-54A each . . . . . 69.95**

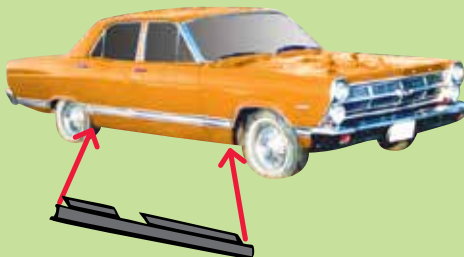

## Steel Rocker Panel

1966-67 Fairlane - 4 door models  
(Stock # B10-17170-100) - *right hand*  
**OEM # C6OZ-10128-54R each . . 45.95**  
(Stock # B10-17175-100) - *left hand*  
**OEM # C6OZ-10129-54L each . . . 45.95**

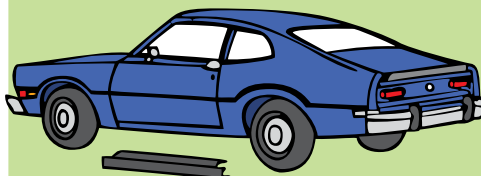

1970 Comet - 2 door models  
(Stock # MB6-36020-210) - *right hand*  
**OEM # D1MY-10128-70 each . . . 45.95**  
(Stock # MB6-36025-200) - *left hand*  
**OEM # D1MY-10129-70 each . . . 45.95**



## Steel Rocker Panel

With 1/4 panel extension.  
1966-69 Fairlane and Torino - 2 door models  
1966-69 Ranchero  
(Stock # B10-17170-125) - *right hand*  
**OEM # C6OZ-10128-62R each . . . 56.95**  
(Stock # B10-17175-125) - *left hand*  
**OEM # C6OZ-10129-62L each . . . 56.95**



## Cowl and Floor Pan Rubber Plugs

These are a necessity!  
1962-72 Fairlane and Comet  
(Stock # PC3-76140) - *1 1/4" plug*  
**OEM # C0AZ-352284-S each . . . . . 2.95**  
(Stock # PC3-76145-005) - *1 1/2" plug*  
**OEM # C0AZ-352285-S each . . . . . 2.95**  
(Stock # PC3-76150) - *3/4" plug*  
**OEM # C0AZ-352291-S each . . . . . 2.95**



## Cowl and Floor Pan Plug

Rubber plug at 1.87".  
1962-72 Fairlane and Torino  
1966-70 Comet and Montego  
(Stock # PC3-76445)  
**OEM # C0AZ-352716-S each . . . . . 2.95**



## Steel Torque Box

1966-71 Fairlane, Torino and Ranchero - except Convertible  
(Stock # B10-17255-200) - *right hand*  
**OEM # C6OZ-10158-62R each . . . . . 273.95**  
(Stock # B10-17255-300) - *left hand*  
**OEM # C6OZ-10159-62L each . . . . . 273.95**



## Rocker Panel Moldings

These are stainless steel rocker panel moldings. Includes complete hardware kit and installation template. 100% made in the U.S.A.!

1963-64 Fairlane  
(Stock # B10-17275-105)  
**OEM # C3OZ-10176/7-62A set . . . . . 499.95**

Miscellaneous Interior Parts

# 1962-72 Fairlane



(A)



(B)

## Molding Clip

1963-64 Fairlane - for rocker and wind-shield molding

(Stock # PB6-36050-010) (A)

OEM # C2YY-10182-62A each . . . 2.95

1966 Fairlane - for rocker molding (B)

(Stock # B10-17275-500)

OEM # C6OZ-10182-62A each . . . 2.95



## Quarter Panel Drain Plugs

1965-72 Fairlane

1968-71 Torino

1966-72 Comet and Montego

(Stock # PB6-36065-005)

OEM # C4AZ-103A58-62D pair . . . 4.95



## Front Floor Crossmember

Die stamped steel - use under rear floor pan

1962-65 Fairlane

(Stock # B10-17405-100) - right hand

OEM # C2OZ-10692-62A each . 101.95

(Stock # F10-17410-035) - left hand

OEM # C2OZ-10693-62A each . . 89.95



## Front Floor Crossmember

Die stamped steel - use under rear floor pan

1966-71 Fairlane/Torino - except Convertible

1968-70 Comet

(Stock # B10-17405-200) - right hand

OEM # C6OZ-10692-62B each . . . 64.95

(Stock # B10-17410-100) - left hand

OEM # C6OZ-10693-62B each . . . 64.95



## Original Style Bolts

5/16" x 24 x 1"

1962-64 Fairlane

1966 Comet

(Stock # PC3-76390)

OEM # COAZ-353483-S each . . . . 0.50

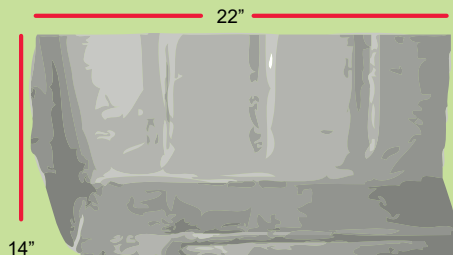

22"

14"

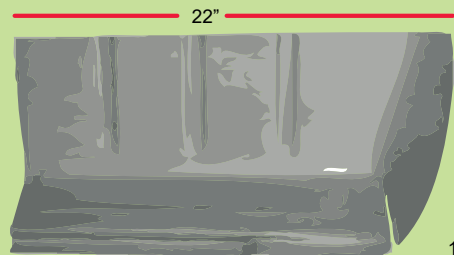

22"

14"

1962-65 Fairlane

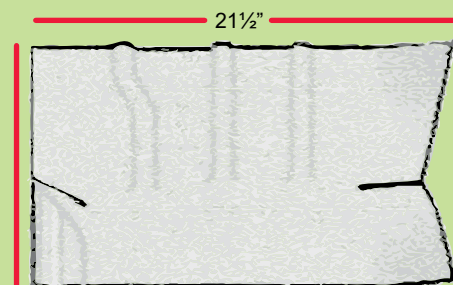

21 1/2"

13 1/2"

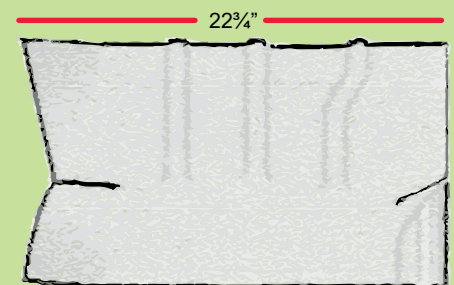

22 3/4"

14 1/2"

1966-71 Fairlane

## Toe Board

Floor to firewall panel.

1962-65 Fairlane - Hardtop - modify for use on Convertibles

(Stock # BB7-37035-005) - right hand

OEM # C4OZ-11132-62R each . . 149.95

(Stock # BB7-37040-005) - left hand

OEM # C4OZ-11133-62L each . . 149.95

1966-71 Fairlane, Torino and Ranchero

(Stock # BB7-37035-010) - right hand

OEM # C6OZ-11132-62R each . . 144.95

(Stock # BB7-37040-010) - left hand

OEM # C6OZ-11133-62L each . . 144.95

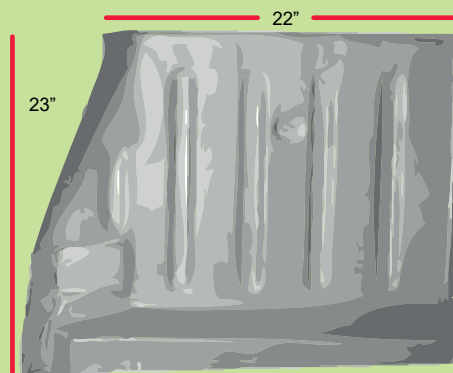

22"

23"

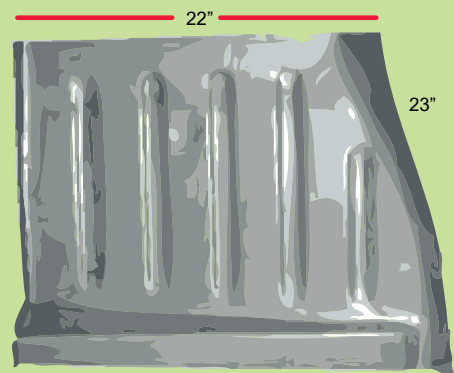

22"

23"

1962-65 Fairlane

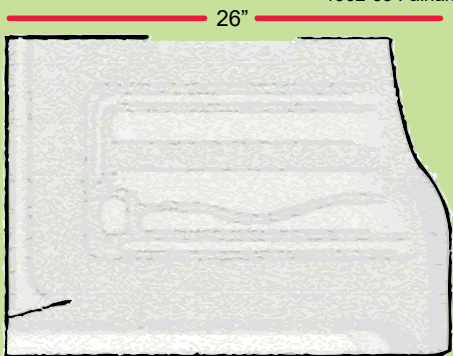

26"

23"

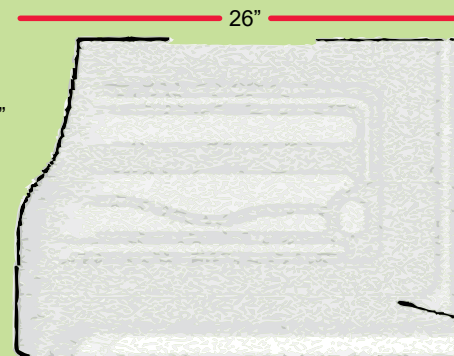

26"

1966-71 Fairlane

## Front Floor Pan

Intended for use on Hardtops. Must be modified for use on Convertibles.

1962-65 Fairlane

(Stock # BB7-37045-030) - right hand

OEM # C4OZ-11135-62RF each . . . .164.95

(Stock # BB7-37050-045) - left hand

OEM # C4OZ-11136-62LF each . . . .164.95

1966-71 Fairlane

(Stock # BB7-37045-035) - right hand

OEM # C6OZ-11135-62RF each . . . .145.95

(Stock # BB7-37050-050) - left hand

OEM # C6OZ-11136-62LF each . . . .145.95

# 1962-72 Fairlane

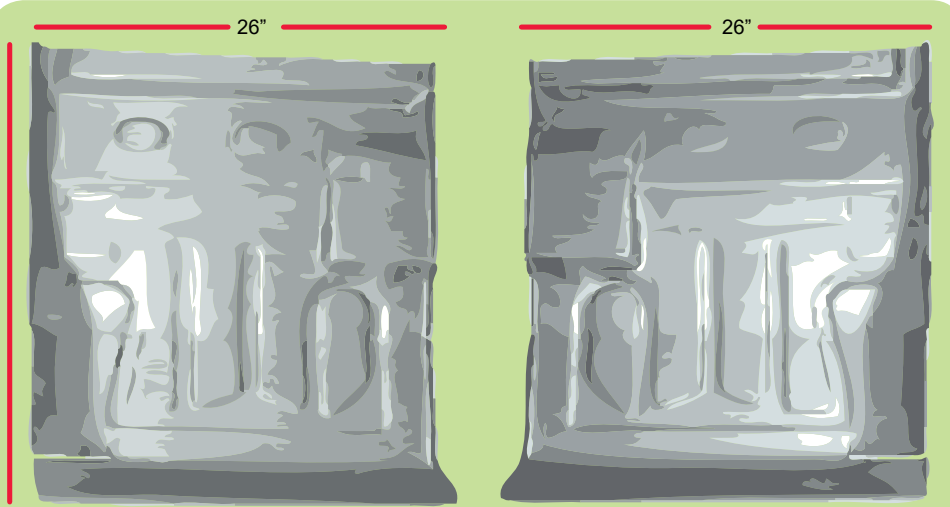

1962-65 Fairlane

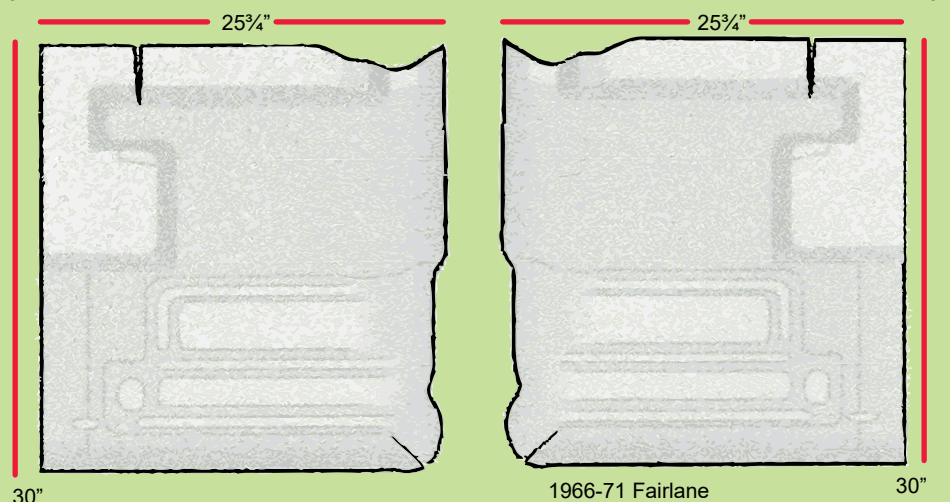

1966-71 Fairlane

## Rear Floor Pan

Rear of metal floor pan. Intended for use on Hardtops. Must be modified to use on convertibles.

- 1962-65 Fairlane  
 (Stock # BB7-37055-005) - right hand Price Reduced!  
**OEM # C4OZ-11137-62RR each . . . 179.95**  
 (Stock # BB7-37060-005) - left hand Price Reduced!  
**OEM # C4OZ-11138-62LR each . . . 164.95**

- 1966-71 Fairlane  
 (Stock # BB7-37055-010) - right hand Price Reduced!  
**OEM # C6OZ-11137-62RR each . . . 166.95**  
 (Stock # BB7-37060-010) - left hand Price Reduced!  
**OEM # C6OZ-11138-62LR each . . . 173.95**



## Rear Floor Pan Drain Valve

- 1963 Meteor  
 1963-65 Fairlane Station Wagon and Sedan Deliver  
 1964-67 Fairlane  
 1966-69 Comet  
 1968-70 Station Wagon  
 (Stock # PB7-37080)  
**OEM # C3AZ-11202-62A each. . . 17.95**



## Rear Quarter Panel Drain Valves

- 1968-72 Fairlane and Torino - except Ranchero and Station Wagon  
 (Stock # PB7-37080-005)  
**OEM # C7ZZ-11202-65A pair . . . 7.95**



## Trunk Filler Patch Panel

- Die stamped steel - 31" long  
 1966-67 Fairlane  
 (Stock # B11-18187-155) - right hand  
**OEM # C6OZ-112A22-62R each . . . 159.95**  
 (Stock # B11-18187-245) - left hand  
**OEM # C6OZ-112A23-62L each . . . 132.95**

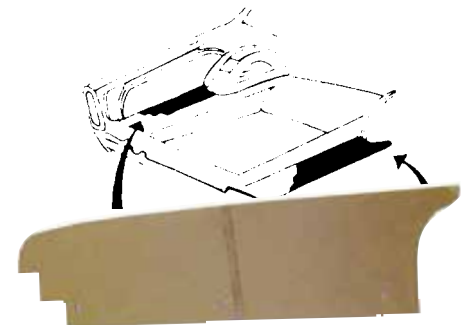

## Trunk Filler Boards

- These fit inside the trunk at the rear outer sides.
- 1963-64 Fairlane  
 (Stock # B11-18190-140) - both sides  
**OEM # C3OZ-11228/9-62 pair . . 22.95**
- 1965 Fairlane  
 (Stock # B11-18187-505) - both sides  
**OEM # C5OZ-11228/9-62 pair . . 22.95**
- 1966 Comet and Cyclone  
 (Stock # MB7-37105-030) - either side  
**OEM # C6GY-11228-63 each . . . 9.95**
- 1966-67 Fairlane  
 (Stock # BB7-37105-050) - both sides  
**OEM # C6OZ-11228/9-63 each . . 19.95**
- 1968-69 Cyclone  
 (Stock # MB7-37105-040) - both sides  
**OEM # C8GY-11228-63A each. . . 16.95**
- 1968-69 Fairlane and Torino  
 (Stock # B11-18187-555) - both sides  
**OEM # C8OZ-11228/9-63 pair . . 19.95**
- 1970-71 Fairlane and Torino and Cyclone  
 (Stock # BB7-37105-045) - both sides Price Reduced!  
**OEM # D0OZ-11228-65A pair . . 21.95**
- 1972-73 Torino  
 (Stock # B11-18187-249) - both sides  
**OEM # D2OZ-11228-65A pair . . 33.95**



# 1962-72 Fairlane

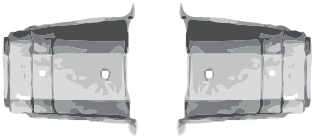

## Front Floor Pan Seat Track Support

1966-71 Fairlane and Torino - except Convertible

1967-70 Comet and Montego

(Stock # B11-18195-065) - right hand Price Reduced!

**OEM # C6OZ-11246-62B each... 74.95**

(Stock # B11-18195-335) - left hand Price Reduced!

**OEM # C6OZ-11247-62B each... 79.95**



## Scuff Plate Mounting Screws

1965-72 Fairlane and Comet

(Stock # SB9-39045-085) - package of 20

**OEM # C3SZ-13208-62MB set... 3.95**



## Front Door Scuff Plates

Perfect reproductions of a very abused and many times missing part. All embossments and patterns are as original. Emblems sold separately.

1962-64 Fairlane - 2 door body styles

(Stock # BB9-39045-285)

**OEM # C3OZ-13208/9-62B pair... 99.95**



## Front Door Scuff Plates

Perfect reproductions of a very abused and many times missing part. All embossments and patterns are as original. Emblems sold separately.

1966-69 Fairlane/Torino - 2 door body styles

(Stock # BB9-39045-300)

**OEM # C6OZ-13208/9-62A pair... 99.95**



## Front Door Scuff Plates

Perfect reproductions of a very abused and many times missing part. All embossments and patterns are as original. Emblems sold separately.

1970-71 Torino - 2 door body styles

(Stock # BB9-39045-100)

**OEM # D0OZ-13208-65A pair... 99.95**

**Some items proudly made in the USA by Dale's Manufacturing!**



## Front Door Scuff Plates

Perfect reproductions of a very abused and many times missing part. All embossments and patterns are as original. Emblems sold separately.

1972 Torino Hardtop and Ranchero

(Stock # BB9-39045-105)

**OEM # D2OZ-13208-65A pair... 99.95**



## Scuff Plate Emblem

1962-64 Fairlane - Black Ford® script with adhesive back.

(Stock # X13-20390-005)

**OEM # C3DZ-13212-EMB each... 1.95**

1966-69 Fairlane and Torino - Blue Ford® script with adhesive back.

(Stock # B13-20390-015)

**OEM # C6OZ-13212-EMB each... 0.00**

1970-71 Torino - Blue Ford® script with adhesive back.

(Stock # X13-20390)

**OEM # CODZ-13212-EMB each... 2.95**

**Call Us:**  
**1-800-654-3247**

We love when our customers bring their cars and trucks by. Feel free to drive yours up and show it off.



Miscellaneous Interior Parts

# 1962-72 Fairlane

**Special  
ORDER**



**MOLDED  
TO FIT**

Please allow  
7-14 days for  
Special Orders!

These are made to  
your specifications  
so they are **NON**  
returnable.

Miscellaneous Interior Parts

Our carpet is molded to the original factory specifications. It is made of 80/20 rayon-nylon loop, the best in the business. The basic 1949-65 carpets are molded, however a few will be cut & sewn as were the originals. The basic 1966 & up are all molded as original. We are going to list the most popular colors which will satisfy the needs of 99% of all cars. We do want to inform you that we can special order almost any color of your choice that may not be listed. Note: All special order items must be pre-paid in advance.

- Contoured to fit over transmission tunnel to eliminate bulges & wrinkles.
- Pre-cut mounting holes (1 piece) available on many sets for ease of installation.
- Dimmer switch cut out is not available on all sets due to the difficulty in accurate placement from car to car.
- Original style plastic compound heel pad - as close to 100 pt. as possible.
- Backing material gives a soft, thick cushion effect for comfort as well as appearance. This is optional on some sets.

Please provide the following information  
at the time of order:

- 1.) Year of Car
- 2.) Body Style
- 3.) Automatic or Standard Transmission
- 4.) Column or Floor shift
- 5.) Bench or Bucket Seats
- 6.) Footwells in the front floor pan -  
yes or no?
- 7.) Power seats - yes or no?
- 8.) Console - yes or no?
- 9.) Color

We can provide up to three color swatches to customers interested in ordering Carpet. Please call customer service to order samples.

We also have them for your online viewing at the following:  
[www.classicautoparts.com/carpets.pdf](http://www.classicautoparts.com/carpets.pdf)

### Molded Carpet Set

1962-72 Fairlane and Comet

(Stock # Z13-20000-255)

**OEM # CARP-13000-SPO each . 224.95**

1962-72 Station Wagon

(Stock # Z13-20000-261)

**OEM # CARP-13000- WGSP0 . . 299.95**

### Carpet By The Square Yard

72" W x 36" L

(Stock # Z13-20000-260)

**OEM # CARP-13000-SQY yard. . . 59.95**

### Color Samples:

We have no control of the printing so these colors may not be accurate. Inquire for samples if needed.



# 1962-72 Fairlane

Miscellaneous Interior Parts

**Special  
ORDER**

## Logo Designs



Logo # 91



Logo # 130



Logo # 114

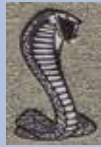
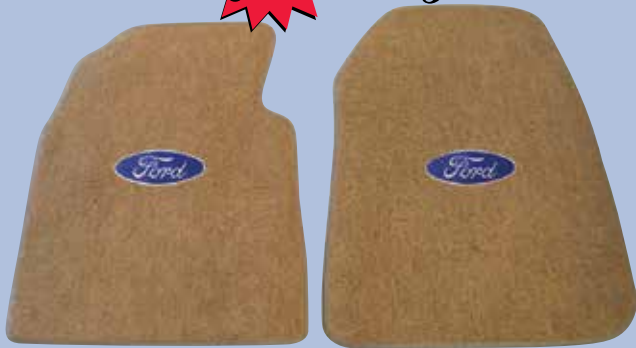

Logo #135



Logo # 41



Logo #133



Logo #220



Logo #129



Logo # 149



Logo # 111



Logo # 232



Logo # 139



Logo # 148



Logo # 287



Logo # 267



Logo # 268



Logo # 154



Logo # 286



Logo # 283

### Embroidered Floor Mats

These floor mats are made from the same carpet stock as our molded carpets. They are produced with the same care and attention as the molded carpets. The bottoms are made of durable, pliable, synthetic material that has nibs formed into it to grip the carpet. This eliminates the need for snaps or other fasteners found on the cheaper floor mats. These hundreds of rubber nibs assure a non-skid floor mat. They have surged edges which prevents separation from the backing. These come in 4 piece sets complete with front & rear mats. Embroidered logos are on the front mats only.

We will need the following information when ordering mats:

- 1.) Year of vehicle
- 2.) Make of vehicle
- 3.) Logo Design # and Embroidery Color
- 4.) Carpet Color

**OEM # FMAT-13000-EMSPO set . . . . . 138.95**



**Special  
ORDER**

### Plain Floor Mats

These floor mats are made from the same carpet stock as our molded carpets. They are produced with the same care and attention as the molded carpets. The bottoms are made of durable, pliable, synthetic material that has nibs formed into it to grip the carpet. This eliminates the need for snaps or other fasteners found on the cheaper floor mats. These hundreds of rubber nibs assure a non-skid floor mat. They have surged edges which prevents separation from the backing. Please specify color when ordering.

- 1.) Year of vehicle
- 2.) Make of vehicle
- 3.) Carpet Color

(Stock # ZB9-39000-130)

**OEM # FMAT-13000-2PSP0 2 piece set . . . . . 82.95**

(Stock # ZB9-39000-135)

**OEM # FMAT-13000-4PSP0 4 piece set . . . . . 105.95**

See Color Samples on Previous Page



**Please allow 7-14 days  
for Special Orders!**

# 1962-72 Fairlane

Miscellaneous Interior Parts



### Carpet Jute Backing

Felt pad that goes underneath the carpet and floor mats. - 1/2" X 36" X 72"

1962-72 Fairlane and Comet

(Stock # VB9-39000-015)

OEM # B-13000-70FP ..... 16.95



**Best SELLER**

### Noise and Heat Insulation Material

Reflective foil insulation consists of two layers of polyethylene bubble film sandwiched between two layers of pure aluminum foil, making a structure 5/16" thick. Temperature range of -60°F to 180°F. Works great for insulating firewalls, headliners, floor pans, trunk area, door panels, kick panels, rumble seat area, etc. Cut and form into needed shapes using scissors and contact cement or weather strip adhesive.

48" x 72" x 5/16"

(Stock # R05-7040-015)

OEM # SR-5010-5 each ..... 26.95

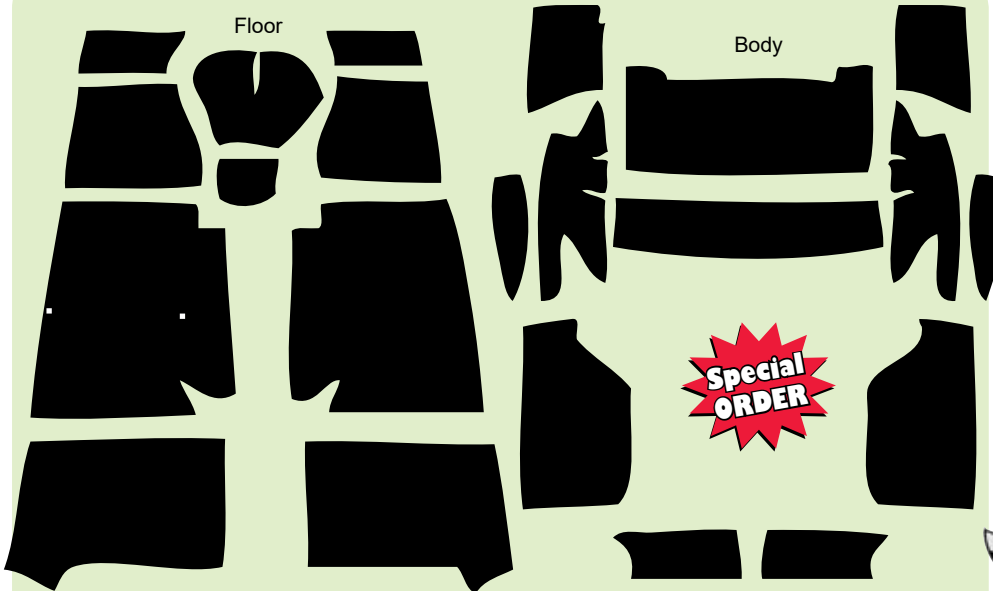

### Acousti-Shield Kit

A multi-stage, automotive insulation and sound damping system to give older Cars and Trucks the "quiet riding comfort" found in today's new vehicles coming off automotive assembly lines. Acousti-Shield kits are designed on current, "state-of-the-art" auto acoustic technology, to insulate and control the noise, vibration and heat in the passenger cabin. These kits are pre-cut and ready-to-install in a couple of hours Everything to do the job right is there. Sound damper pads, pre-trimmed heat absorber, barrier panels, spray adhesive and sealing tape. Kits include pieces for the cowl area, the roof, the trunk, the body and the floor. Great Item !!

1962-65 Fairlane - Coupe

(Stock # B13-20005-110)

OEM # C2OZ-13001-CAK set ..... 675.00

1962-65 Fairlane - Sedan

(Stock # B13-20005-100)

OEM # C2OZ-13001-SAK set ..... 799.95

1965-71 Fairlane - Convertible

(Stock # B13-20005-120)

OEM # C5OZ-13001-CVAK set ..... 725.00

1966-71 Fairlane and Torino - Coupe

(Stock # B13-20005-140)

OEM # C6OZ-13001-CAK set ..... 675.00

1966-71 Fairlane and Torino - Sedan

(Stock # B13-20005-160)

OEM # C6OZ-13001-SAK set ..... 675.00

1966-71 Ranchero

(Stock # B13-20005-200)

OEM # C7OZ-13001-RAK set ..... 609.95

1972 Ranchero

(Stock # B13-20005-250)

OEM # D2OZ-13001-RAK set ..... 609.95



### Body Insulation Sheeting

This is a heat resistant, waterproof, sound deadening material that fits under the headliner, carpet, door panels, firewall, etc. It has a self-adhesive backing for easy installation and non-slip coverage. High density rubber.

32" x 50" sheet

(Stock # V05-7040-005)

OEM # B-5010-FSS each ..... 36.95



Please allow 7-14 days for Special Orders!

# 1962-72 Fairlane

All Our Stripe Kits are excellent quality automotive grade vinyls. They have special agents added for UV protection to help eliminate fading. Mill thicknesses are equal to the original OE stripes. These are really the best stripe kits on the market today!

Stripe Kits

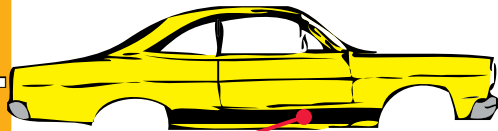

## Stripe Kit

1966-67 Fairlane GT

1966-67 Comet - Hardtop and Convertible

(Stock # B20-40000-085) - **black** Price Reduced!

OEM # C6OZ-20000-63D kit . . . . 38.95

(Stock # B20-40000-090) - **white** Price Reduced!

OEM # C6OZ-20000-63E kit . . . . 47.95

(Stock # B20-40000-095) - **red**

OEM # C6OZ-20000-63F kit. . . . . 47.95

(Stock # B20-40000-100) - **blue**

OEM # C6OZ-20000-63G kit . . . . 47.95

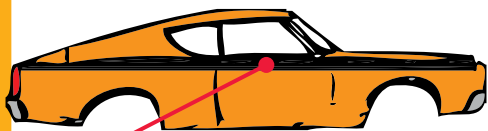

## Upper Body Stripe Kit

1968 Cyclone

(Stock # M20-40000-105) - **white**

OEM # C8GY-20000-63A kit . . . 126.95

(Stock # M20-40000-11) - **black**

OEM # C8GY-20000-63B kit . . . 139.95

(Stock # M20-40000-115) - **red**

OEM # C8GY-20000-63C kit . . . 139.95

(Stock # M20-40000-120) - **blue**

OEM # C8GY-20000-63D kit . . . 139.95

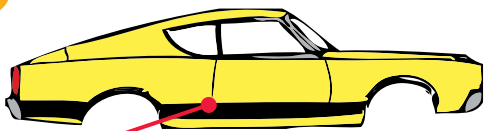

## Lower Body Stripe Kit

1968 Cyclone

(Stock # M20-40000-125) - **white**

OEM # C8GY-20000-65A kit . . . . 54.95

(Stock # M20-40000-130) - **black**

OEM # C8GY-20000-65B kit . . . . 69.95

(Stock # M20-40000-135) - **red**

OEM # C8GY-20000-65C kit . . . . 69.95

(Stock # M20-40000-140) - **blue**

OEM # C8GY-20000-65D kit . . . . 69.95



## 'C' Stripe Kit

1968 Torino

(Stock # B20-40000-145) - **black**

OEM # C8OZ-20000-63A pair . . . 99.95

(Stock # B20-40000-150) - **red**

OEM # C8OZ-20000-63C pair . . . 99.95

(Stock # B20-40000-155) - **white**

OEM # C8OZ-20000-63D pair . . . 99.95

(Stock # B20-40000-160) - **gold**

OEM # C8OZ-20000-63E pair . . . 99.95

## Reflective 'C' Stripe Kit

1968 Torino

(Stock # B20-40000-165) - **black**

OEM # C8OZ-20000-63F pair . . 199.95

(Stock # B20-40000-170) - **gold**

OEM # C8OZ-20000-63G pair . . 199.95



## Lower GT Stripe Kit

1968 Torino

(Stock # B20-40000-175) - **black**

OEM # C8OZ-20000-65A kit . . . . 85.95

(Stock # B20-40000-180) - **blue**

OEM # C8OZ-20000-65B kit . . . . 69.95

(Stock # B20-40000-185) - **red**

OEM # C8OZ-20000-65C kit . . . . 69.95

(Stock # B20-40000-190) - **white**

OEM # C8OZ-20000-65D kit . . . . 69.95

(Stock # B20-40000-195) - **gold**

OEM # C8OZ-20000-65E kit . . . . 69.95

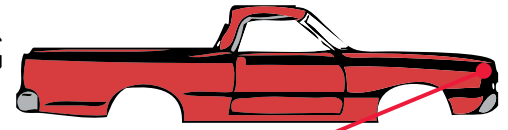

## Ranchero 'C' Stripe Kit

1968 Ranchero

(Stock # B20-40000-200) - **white**

OEM # C8OZ-20000-66A kit . . . 127.95

(Stock # B20-40000-205) - **black**

OEM # C8OZ-20000-66B kit . . . 179.95

(Stock # B20-40000-210) - **red**

OEM # C8OZ-20000-66C kit . . . 179.95

(Stock # B20-40000-215) - **gold**

OEM # C8OZ-20000-66D kit . . . 179.95

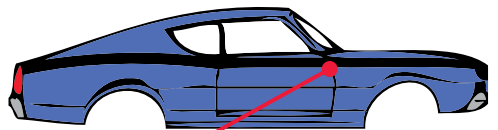

## Upper Body Stripe Kit

1969 Cyclone

(Stock # M20-40000-220) - **white**

OEM # C9GY-20000-63A kit . . . 139.95

(Stock # M20-40000-225) - **black**

OEM # C9GY-20000-63B kit . . . 139.95

(Stock # M20-40000-230) - **red**

OEM # C9GY-20000-63C kit . . . 139.95

(Stock # M20-40000-235) - **blue**

OEM # C9GY-20000-63D kit . . . 139.95

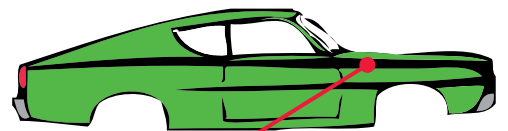

## 'C' Stripe Kit

1969 Torino

(Stock # B20-40000-240) - **black**

OEM # C9OZ-20000-63A kit . . . . 99.95

(Stock # B20-40000-245) - **gold**

OEM # C9OZ-20000-63B kit . . . . 99.95

(Stock # B20-40000-250) - **red**

OEM # C9OZ-20000-63C kit . . . . 99.95

(Stock # B20-40000-255) - **white**

OEM # C9OZ-20000-63D kit . . . . 99.95

## Reflective 'C' Stripe Kit

1969 Torino

(Stock # B20-40000-265) - **gold**

OEM # C9OZ-20000-63F kit. . . . 206.95

(Stock # B20-40000-270) - **black**

OEM # C9OZ-20000-63G kit . . . 199.95

We accept these MAJOR credit cards.



# 1962-72 Fairlane

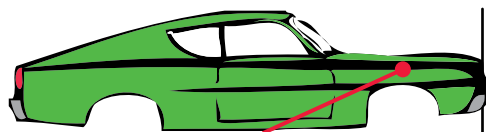

## Talladega Stripe Kit

1969 Talladega  
 (Stock # B20-40000-275) - **black**  
**OEM # C9OZ-20000-63K kit . . . 157.95**  
 (Stock # B20-40000-280) - **white**  
**OEM # C9OZ-20000-63L kit. . . 149.95**



## Ranchero 'C' Stripe Kit

1969 Ranchero  
 (Stock # B20-40000-285) - **white**  
**OEM # C9OZ-20000-66A kit . . . 249.95**  
 (Stock # B20-40000-290) - **black**  
**OEM # C9OZ-20000-66B kit . . . 249.95**  
 (Stock # B20-40000-295) - **red**  
**OEM # C9OZ-20000-66C kit . . . 249.95**  
 (Stock # B20-40000-300) - **gold**  
**OEM # C9OZ-20000-66D kit . . . 249.95**



## Spoiler Stripe Kit

1970 Cyclone  
 (Stock # M20-40000-305) - **black**  
**OEM # D0GY-20000-65A kit . . . 194.95**  
 (Stock # M20-40000-310) - **white**  
**OEM # D0GY-20000-65D kit . . . 194.95**

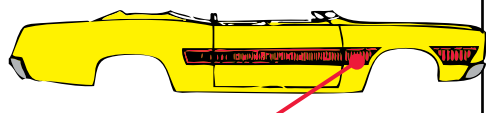

## Laser Stripe Kit

1970 Torino  
 (Stock # B20-40000-315) - **blue**  
**OEM # D0OZ-20000-63A kit . . . 419.95**  
 (Stock # B20-40000-320) - **red**  
**OEM # D0OZ-20000-63B kit . . . 419.95**  
 (Stock # B20-40000-325) - **green**  
**OEM # D0OZ-20000-63C kit . . . 419.95**  
 (Stock # B20-40000-330) - **brown**  
**OEM # D0OZ-20000-63D kit . . . 419.95**

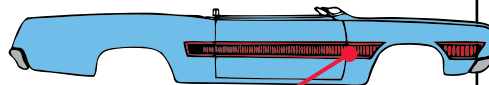

## Laser Stripe Kit

1971 Torino  
 (Stock # B20-40000-340) - **blue**  
**OEM # D1OZ-20000-63A kit . . . 419.95**  
 (Stock # B20-40000-345) - **red**  
**OEM # D1OZ-20000-63B kit . . . 419.95**  
 (Stock # B20-40000-350) - **green**  
**OEM # D1OZ-20000-63C kit . . . 419.95**  
 (Stock # B20-40000-355) - **brown**  
**OEM # D1OZ-20000-63D kit . . . 419.95**



## Laser Stripe Kit

Includes all fender, door and quarter panel pieces.  
 1971 Torino GT and Ranchero  
 (Stock # B20-40000-360) - **blue**  
**OEM # D1OZ-20000-66A kit . . . 539.95**  
 (Stock # B20-40000-365) - **red**  
**OEM # D1OZ-20000-66B kit . . . 539.95**  
 (Stock # B20-40000-370) - **green**  
**OEM # D1OZ-20000-66C kit . . . 539.95**  
 (Stock # B20-40000-375) - **brown**  
**OEM # D1OZ-20000-66D kit . . . 539.95**

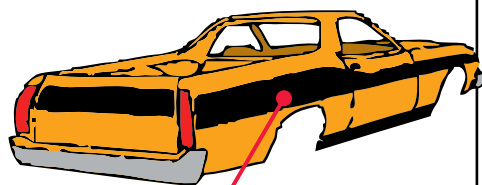

## 'GT' Stripe Kit

Features black outer line with colored insert as original. Includes full body sides and tailgate decal.  
 1972 Ranchero GT  
 (Stock # B20-40000-380) - **blue**  
**OEM # D2OZ-20000-97F kit . . . 329.95**  
 (Stock # B20-40000-385) - **yellow**  
**OEM # D2OZ-20000-97G kit . . . 449.95**  
 (Stock # B20-40000-390) - **orange**  
**OEM # D2OZ-20000-97H kit . . . 449.95**  
 (Stock # B20-40000-395) - **silver**  
**OEM # D2OZ-20000-97J kit. . . 329.95**

## Obsolete & Classic Auto Parts, Inc.

8701 South I-35  
 Oklahoma City, OK 73149

### Summer Store Hours:

Monday - Friday  
 8 a.m. thru 6 p.m.  
 Saturday  
 8 a.m. thru 12 p.m.

### Winter Store Hours:

Monday - Friday  
 8 a.m. thru 5 p.m.  
 Saturday  
 8 a.m. thru 12 p.m.  
 (Central Standard Time)

We accept VISA • DISCOVER  
 MASTERCARD

check us out at  
[www.classicautoparts.com](http://www.classicautoparts.com)

**NEXT DAY AIR**  
 service available  
 on ALL orders!



Stripe Kits

**Call Us:**

**1-800-654-3247**

# 1962-72 Fairlane

Door & Window Parts



## Door Panel Metal Clips

1962-67 Fairlane

(Stock # P20-40062-001) - set of 50

**OEM # B8A-20015-70 set . . . . . 14.95**

1968-71 Fairlane and Torino

(Stock # P20-40062-005) - set of 50

**OEM # C8AZ-20015-70 set . . . . . 19.95**



## Lower Door Patch Panel

Die stamped steel - 61" long x 8" tall

1966-67 Fairlane and Ranchero - 2 door

(Stock # B20-40075-035) - right hand

**OEM # C6OZ-20122-62LDS each. . . . . 72.95**

(Stock # B20-40080-035) - left hand

**OEM # C6OZ-20123-62LDS each. . . . . 72.95**

Illustration 1



Illustration 3



Illustration 2



## Universal Door Seal

This is an OEM type door seal that we offer by the foot. It will be exactly as many of the Ford® product cars, but you will need to "razor blade" your specially molded ends and glue them onto the seal. These door seals will help many people with cars that molded seals are no longer available. This is USA made, top quality rubber.

(Stock # P20-40200-175) - illustration 1

**OEM # C0AZ-20530-UK 30' roll. . 29.95**

(Stock # P20-40200-310) - illustration 2

**OEM # C7AZ-20530-UK 30' roll. . 29.95**

(Stock # X20-40200-315) - illustration 3

**OEM # C7DZ-20530-UK 30' roll. . 29.95**

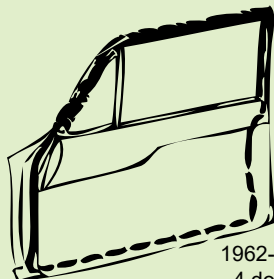

1962-64 Fairlane  
- 4 door Sedan



1966-67 Ranchero

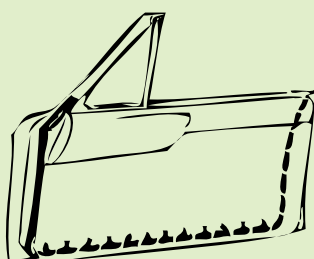
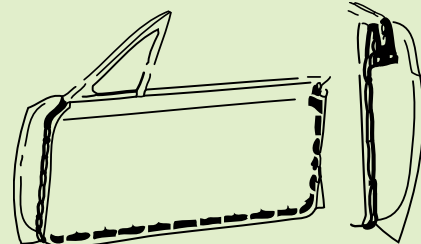

1963-65 Fairlane



1968-69 Fairlane

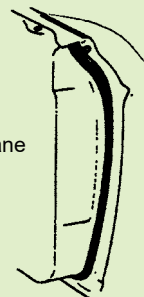

## Door Seal Kits

These kits are new, fresh USA reproductions. They are exact in every detail. They include the front, top, back and bottom sides with specially molded corners as came originally on your car. No detail is left out. One kit is enough for one car. Glue on with black weatherstrip adhesive.

1962-64 Fairlane - 4 door Sedan

1962-63 Meteor - 4 door Sedan and Station Wagon

(Stock # B20-40200-245)

**OEM # C3OZ-20530-54S kit. . . . . 227.95**

1962-64 Fairlane - 2 door Sedan

1962-63 Meteor - 2 door Sedan

(Stock # B20-40200-385)

**OEM # C3OZ-20530/1-62A kit . . . . . 139.95**

1963-65 Fairlane - 2 door Hardtop

1963 Meteor - 2 door Hardtop

(Stock # B20-40200-390)

**OEM # C3OZ-20530/1-65B kit . . . . . 134.95**

1966-67 Ranchero

(Stock # X20-40200-290)

**OEM # C6DZ-20530-66A kit . . . . . 143.95**

1966-67 Fairlane - 4 door Sedan and Station Wagon

(Stock # B20-40187-055)

**OEM # C6OZ-20530-54A kit . . . . . 134.95**

1966-67 Fairlane - 2 door Sedan

(Stock # B20-40200-300)

**OEM # C6OZ-20530-62A kit . . . . . 143.95**

1966-67 Fairlane - 2 door Hardtop and Convertible

(Stock # B20-40200-400)

**OEM # C6OZ-20530/1-63A kit . . . . . 49.95**

1968-69 Fairlane - Ranchero, Convertible, 2 door Fastback and Notchback

1968-69 Montego - Hardtop, Notchback and Convertible

(Stock # B20-40200-325)

**OEM # C8OZ-20530-63A kit . . . . . 143.95**

1970-71 Torino - 2 door Fastback, Notchback and Convertible

(Stock # B20-40200-340)

**OEM # D0OZ-20530-65A kit . . . . . 178.95**

1970-71 Ranchero

(Stock # B20-40200-345)

**OEM # D0OZ-20530-66 kit . . . . . 144.95**

1972 Torino - Fastback, Notchback and Ranchero

(Stock # B20-40200-350)

**OEM # D2OZ-20530-65A kit . . . . . 179.95**



**An American Classic!**

# 1962-72 Fairlane



### Window Corner Seals

Upper front corner of the door to window  
1968-69 Fairlane/Torino

(Stock # B20-40195) **(A)**

**OEM # C8OZ-20524/5-63D pair . . . . .29.95**

1970-71 Torino

(Stock # B20-40225-005) **(B)**

**OEM # D0OZ-20564/5-65 pair . . . . .29.95**



### Door Molding Clip

1964 Fairlane - Sedan and Station Wagon  
(Stock # B21-41035-025)

**OEM # C4OZ-21094-62B each . . . 2.95**



### Door Hinge Lower Spring

11 coils on the spring

1964-70 All

(Stock # X21-41080-035)

**OEM # C0DZ-21232-64B each . . . 3.95**

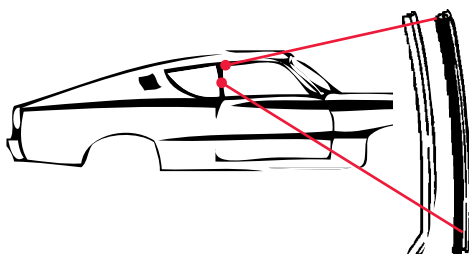

### Quarter Window to Door Glass Seals

1968-69 Fairlane/Torino - Fastback and Hardtop

(Stock # B21-41125-015)

**OEM # C8OZ-214A14/5-63A pair . . . .47.95**

### BULK WINDOW CHANNELING

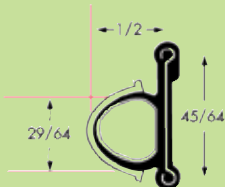

### Bulk Window Channel

96" Stick - Universal Application

(Stock # Z21-41145-010)

**OEM # U-21446-MR39X each . . . 20.95**

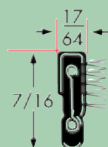

### Flexible Pile Lining Rubber-Covered

96" Stick - Universal Application

(Stock # Z21-41145)

**OEM # U-21446-M123 each . . . 14.95**

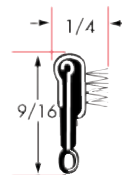

### Flexible Pile Lining Rubber-Covered

96" Stick - Fabric covered bead

(Stock # Z21-41145-005)

**OEM # U-21446-M8 each . . . . . 19.95**



### Rigid Weatherstrip

72" Stick - Rubber covered with stainless bead

(Stock # Z21-41145-045)

**OEM # U-21446-YMR219 each . . 19.95**

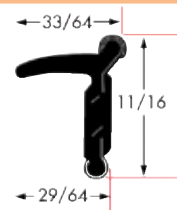

### Rigid Weatherstrip

72" Stick - Rigid rubber lip rubber covered with stainless bead

(Stock # Z21-41145-015)

**OEM # U-21446-YM108 each . . . 19.95**



### Flexible Pile Lining

72" Stick - Rubber covered with stainless bead

(Stock # Z21-41145-020)

**OEM # U-21446-YM3 each . . . . . 20.95**

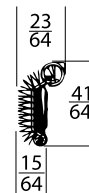

### Flexible Weatherstrip

72" stick

(Stock # Z21-41145-035)

**OEM # U-21446-YM68 each . . . 19.95**

### Door Seal and Tailgate Seal Retaining Clips

1966-71 Fairlane/Torino

1967-70 Comet/Montego

(Stock # P20-40250) - set of 10

**OEM # C5AZ-20586-62A set . . . . . 5.95**



### Door Panel Bottom Drain Seal Fasteners

1965 Fairlane

(Stock # P20-40280) - set of 10

**OEM # C1AB-20807-62A set . . . . . 2.95**



### Molding Clip

Used on several places on the car.

1962-72 All

(Stock # X20-40292-100)

**OEM # C8MB-20844-54C each . . . 0.00**



### Body Side Molding Clip

1964 Fairlane

(Stock # B21-41035-020)

**OEM # C4OZ-21094-62A each . . . 2.95**



# 1962-72 Fairlane

Door & Window Parts

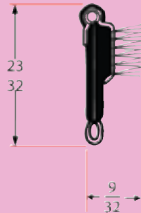

### Flexible Pile Lining

72" Stick - Rubber covered with stainless bead

(Stock # Z21-41145-025)

OEM # U-21446-YM30 each . . . . 19.95

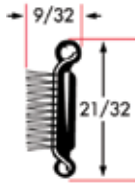

### Rigid Weatherstrip

72" Stick - Rubber covered with stainless bead

(Stock # Z21-41145-030)

OEM # U-21446-YM52RP each . . 19.95



### Flexible Pile Lining

72" Stick - Rubber covered with stainless bead

(Stock # Z21-41145-040)

OEM # U-21446-YM93 each . . . . 19.95

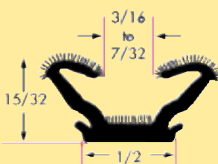

### Flexible Non-beaded Window Channel

96" long - Flexible flocked lining, all rubber

(Stock # Z21-41250-070)

OEM # U-21550-AS1340 each . . 20.95

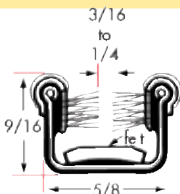

### Flexible Pile Lining Rubber-Covered

72" Stick - Fabric covered bead

(Stock # Z21-41250-075)

OEM # U-21550-Y526 each . . . . 19.95

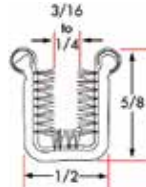

### Rigid Weatherstrip

72" Stick - Unlined

(Stock # Z21-41250-080)

OEM # U-21550-Y619P each . . . . 19.95

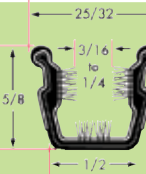

### Beaded Window Channel

72" long - pile lining - rubber covered

(Stock # Z21-41250-085)

OEM # U-21550-Y620 each . . . . 29.95

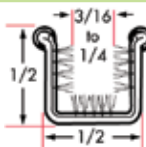

### Beaded Window Channel

72" long - rigid - pile lining - uncovered

(Stock # Z21-41250-090)

OEM # U-21550-Y658X each . . . . 29.95

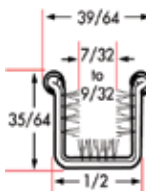

### Rigid Weatherstrip

72" Stick - Pile Lining - Unlined

(Stock # Z21-41250-095)

OEM # U-21550-Y660X each . . . . 29.95

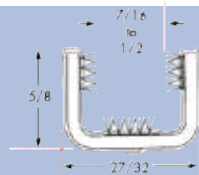

### Flexible Non-beaded Window Channel

72" Stick - Pile lining - cloth covered

(Stock # Z21-41250-055)

OEM # U-21550-10E1 each . . . . 29.95



### Window Felt Channel Clip

Original style with tabs.

(Stock # P45-57185-350) - package of 10

OEM # B2A-45983-CL pkg . . . . . 3.95

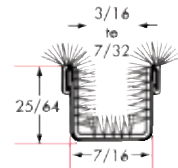

### Rigid Weatherstrip

96" Stick - Pile Lining - Uncovered

(Stock # Z21-41250-060)

OEM # U-21550-25JP each . . . . 19.95

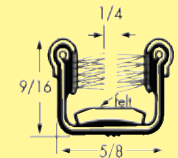

### Non-beaded Window Channel

60" Stick - flexible felt lining - rubber covered

(Stock # Z21-41250-065)

OEM # U-21550-3C1 each . . . . . 15.95

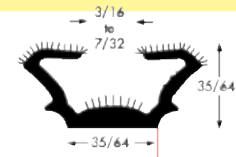

### Flexible Non-beaded Window Channel

96" long - Flexible flocked lining, all rubber

(Stock # Z21-41255)

OEM # U-21551-AS1395 each . . . . . 19.95



### Window "U" Channel Clip

Fits on many of the door glass run channels.

(Stock # F45-57185-360) - package of 10

OEM # BAAA-45983-1216K pkg . . . . . 6.95



### Window Felt Staples

(Stock # VC7-77295-015)

Price Reduced

OEM # 78-703536-K kit . . . . . 4.95



### Window Felt 'Z' Clips

Used to hold felt strips on garnish moldings

(Stock # VC7-77295-010) - set of 10

OEM # 48-703536-K set . . . . . 8.95



### Window Felt Channel Clip

This is the most commonly used clip.

(Stock # F45-57185-265) - package of 10

OEM # 8C-45983-1105K pkg . . . . . 4.95

# 1962-72 Fairlane

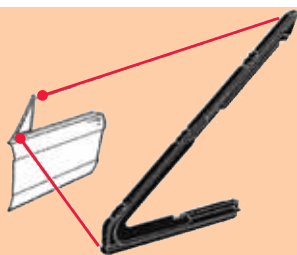

## Vent Window Rubber Weatherstrip

- 1962-65 Fairlane - except 2 door Hardtop  
 1962-63 Meteor - except 2 door Hardtop  
 (Stock # B21-41150-220)  
**OEM # C2OZ-21448/9-62B pair . . . .289.95**  
 1963-64 Fairlane - '500' 2 door Hardtop  
 1962-63 Meteor - 2 door Hardtop  
 (Stock # B21-41150-235)  
**OEM # C3OZ-21448/9-65A pair . . . .239.95**  
 1963 Meteor - Sedan, Hardtop, St Wagon  
 1966 Fairlane - Sedan and St Wagon  
 1966-70 Comet  
 1967 Fairlane - Sedan, St Wagon, Ranchero  
 1968-71 Fairlane - 4 door Station Wagon  
 (Stock # B21-41150-270)  
**OEM # C6OZ-21448/9-62 pair . . . .269.95**  
 1966-67 Fairlane/Comet - 2 door Hardtop and Convertible  
 (Stock # B21-41150-280)  
**OEM # C6OZ-21448/9-63A pair . . . .89.95**

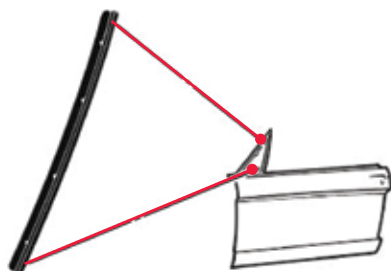

## Back Edge of Vent Seal

- For the straight back edge of the vent window. Does not come with the vent seals.  
 1962-65 Fairlane - 2 dr Sedan and Station Wagon  
 (Stock # B21-41160-100)  
**OEM # C2OZ-21450-62A pair . . . .174.95**



## Glass Setting Tape

- Cork like material used to set glass to frame. 20' roll  
 (Stock # V30-50385) - 1 1/2" x 1/2"  
**OEM # V30-50385-005 each . . . .11.95**  
 (Stock # V30-50385-005) - 1 1/2" x 1/8"  
**OEM # B-37001-B each . . . . .15.95**

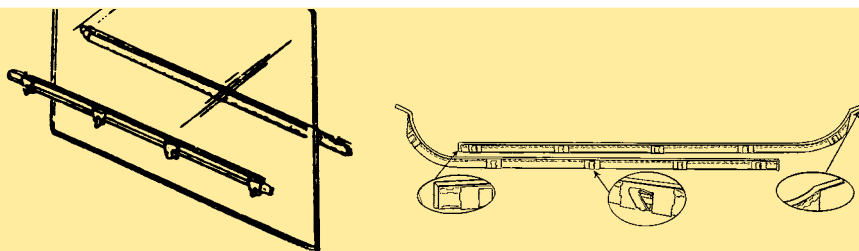

## Door Window Felt Weatherstrip Kits

We have our own shop where we manufacture all our window felt kits. We have drastically increased this product line in the past few years, and now have the capability to duplicate any original felt kit. If you don't see your application listed, it's because we have not received a good original sample for a pattern. Call us and talk about sending your old set. We should be able to give immediate service on these kits. All door glass anti-rattler kits come complete with clips installed and with the end pre-bent as original. Kit also includes one outer piece for your door and one inner piece for garnish molding with installation staples as original.

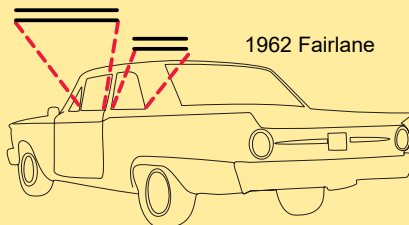

- 1962 Fairlane - 2 Door Sedan  
 (Stock # B21-41165-335) - 8 pieces  
**OEM # C2OB-21452/3-62K kit . . . . .89.95**  
 1962-65 Fairlane - 4 door Sedan  
 (Stock # B21-41165-340) - 8 pieces  
**OEM # C2OZ-21452/3-54K kit . . . . .89.95**  
 1963-65 Fairlane - 2 door Sedan  
 (Stock # B21-41165-425) - 8 pieces  
**OEM # C3OZ-21452/3-62K kit . . . . .89.95**  
 1963-65 Fairlane - 2 door Hardtop and Convertible  
 (Stock # B21-41165-430) - 8 pieces  
**OEM # C3OZ-21452/3-65K kit . . . . .79.95**  
 1966-67 Fairlane/Comet - 4 door Sedan  
 (Stock # B21-41165-485) - 8 pieces  
**OEM # C6OZ-21452/3-54K kit . . . . .99.95**

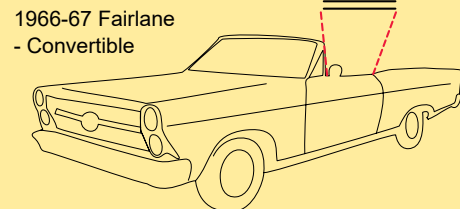

- 1966-67 Fairlane - 2 door Sedan  
 (Stock # B21-41165-490) - 8 pieces  
**OEM # C6OZ-21452/3-62K kit . . . .119.95**  
 1966-67 Fairlane/Comet - 2 door Hardtop and Convertible  
 (Stock # B21-41165-495) - 8 pieces  
**OEM # C6OZ-21452/3-63K kit . . . .128.95**  
 1966-67 Ranchero  
 (Stock # B21-41165-500) - 4 pieces  
**OEM # C6OZ-21452/3-66K kit . . . . .59.95**  
 1966-67 Fairlane - Convertible  
 (Stock # B21-41165-505) - 8 pieces  
**OEM # C6OZ-21452/3-76K kit . . . .119.95**

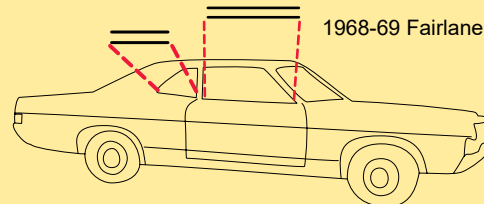

- 1968-69 Fairlane and Torino - Fastback  
 1968-69 Comet and Montego - Fastback  
 (Stock # B20-40375-110) - 8 pieces  
**OEM # C8OZ-20934/5-63K kit . . . .129.95**  
 1968-69 Fairlane - 4 door Sedan  
 1968-69 Comet and Montego - 4 door Sedan  
 (Stock # B21-41165-535) - 8 pieces  
**OEM # C8OZ-21452/3-54K kit . . . .128.95**  
 1968-69 Fairlane and Torino  
 (Stock # B21-41165-545) - 8 pieces  
**OEM # C8OZ-21452/3-65K kit . . . .139.95**  
 1968-69 Fairlane and Torino - 2 door Hardtop - with upper door chrome  
 (Stock # B20-40375-115) - 8 pieces  
**OEM # C8OZ-20934/5-65K kit . . . .129.95**  
 1968-69 Ranchero - without upper door chrome  
 (Stock # B21-41165-550) - 4 pieces  
**OEM # C8OZ-21452/3-66K kit . . . .89.95**  
 1968-69 Fairlane and Ranchero - with upper door chrome  
 (Stock # B20-40375-120) - 4 pieces  
**OEM # C8OZ-20934/5-66K kit . . . .99.95**  
 1968-69 Fairlane - 4 door Station Wagon  
 (Stock # B21-41165-542)  
**OEM # C8OZ-21452/3-57K kit . . . .105.95**  
 1968-69 Fairlane and Torino - Convertible  
 (Stock # B21-41165-555) - 8 pieces  
**OEM # C8OZ-21452/3-76K kit . . . .128.95**

Weatherstrip Kits continued on the following page!

# 1962-72 Fairlane

1970-71 Fairlane -  
2 door Hardtop

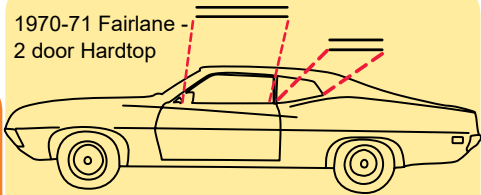

### Felt Weatherstrip Kits

- 1970 Fairlane - 2 door Sedan  
(Stock # B21-41165-570) - 8 pieces
- OEM # D00Z-21452/3-62K kit . . . . .129.95**
- 1970-71 Fairlane and Torino - 2 door  
Hardtop with formal roof  
(Stock # B21-41165-575) - 8 pieces
- OEM # D00Z-21452/3-65BK kit . . . . .128.95**
- 1970-71 Fairlane and Torino - 2 dr Hard-  
top
- 1970-71 Comet, Montego, Cyclone - 2  
door Hardtop  
(Stock # B21-41165-580) - 8 pieces
- OEM # D00Z-21452/3-65K kit . . . . .0.00**
- 1970-71 Ranchero **Price  
Reduced!**  
(Stock # B21-41165-585) - 8 pieces
- OEM # D00Z-21452/3-66K kit . . . . .79.95**
- 1970-71 Torino - Fastback  
(Stock # B20-40375-180) - 8 pieces
- OEM # D00Z-20934/5-63K kit . . . . .129.95**
- 1970-71 Fairlane and Torino - Convertible  
(Stock # B20-40375-195) - 8 pieces
- OEM # D00Z-20934/5-76K kit . . . . .119.95**
- 1970-71 Ranchero - with upper door  
chrome  
(Stock # B20-40375-190) - 4 pieces
- OEM # D00Z-20934/5-66K kit . . . . .79.95**
- 1970-71 Comet, Montego and Cyclone  
(Stock # M21-41165-595) - 8 pieces
- OEM # D1GY-21452/3-65K kit . . . . .97.95**
- 1970-71 Torino - Fastback  
(Stock # B20-40375-175) - 4 pieces
- OEM # D00Z-20934/5-63A kit . . . . .129.95**

1972-76 Ranchero

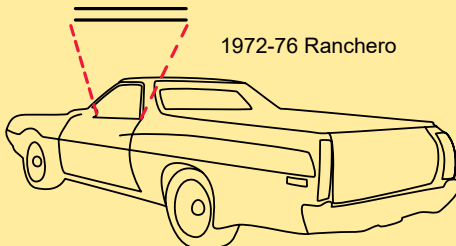

- 1972-76 Ranchero  
(Stock # B21-41165-605) - 4 pieces
- OEM # D20Z-21452/3-66K kit . . . . .89.95**

**Some items proudly  
made in the USA by  
Dale's Manufacturing!**

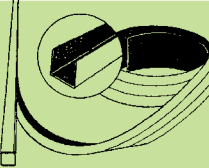

### Mohair Channel Liner

This is a non adhesive lining that has a much thicker pile which is super close to the original lining in your window channeling. Comes in a 30" roll.  
(Stock # S21-41225-005)  
**OEM # B5S-21508-MH roll . . . . . 11.95**

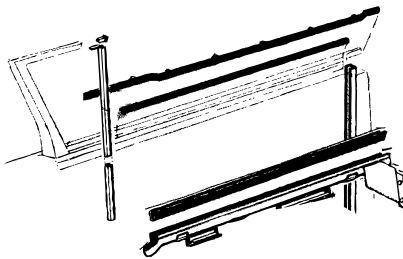

### Door Glass Lower Channel Rubber Seals

1966-69 Fairlane - 4 door Sedan and Station Wagon  
1966-69 Fairlane - 2 door Sedan and Ranchero  
(Stock # P21-41230)  
**OEM # C5AZ-21510-62 pair . . . . . 19.95**



### Division Bar Rivet Kit

1962-68 Fairlane - Convertible  
1966-70 Comet  
(Stock # P21-41235) - set of 10  
**OEM # 0A-21524-70K set . . . . . 3.95**



### Lower Door Glass Stop Bumper

For front or rear doors  
1962 Fairlane  
(Stock # B21-41310-005)  
**OEM # C20Z-21762-62A each . . . 2.95**



### Lower Door Glass Bumper

1963-64 Fairlane - Sedan - front door only  
(Stock # B21-41310-010)  
**OEM # C30Z-21762-76A each . . . 4.95**



### Front Door Glass Run

1966 Comet - front door 2 door and 4 door Sedan  
1966-69 Comet 4 door Sedan and Station Wagon - rear door  
(Stock # P21-41245-010)  
**OEM # C5AZ-21546-63A each . . . 9.95**  
1966-67 Fairlane and Comet- Hardtop and Convertible  
(Stock # B21-41245-050)  
**OEM # C60Z-21546/7-63A pair . 19.95**  
1966-67 Fairlane - 2 door Sedan  
(Stock # B21-41245-015)  
**OEM # C60Z-21546-62A each . . . 9.95**



### Front Door Glass Run

Lock side - 60" stick  
1966-67 Ranchero  
(Stock # P21-41250-045)  
**OEM # C3AZ-21550-62A each . . . 12.95**



### Lower Door Glass Bumper

1966-67 - Hardtop  
(Stock # B21-41310-020)  
**OEM # C60Z-21762-76S each . . . 4.95**



### Lower Door Glass Bumper

Rubber bumper that installs inside the bottom of the door that stops the travel of door glass. One required per door glass, snaps into place.  
1970 Fairlane  
(Stock # B21-41310-017)  
**OEM # C5ZZ-21762-65B each . . . 3.95**

# 1962-72 Fairlane



## Front Door Pawl Bushing Set

1965 Fairlane - requires 2 per car  
(Stock # B21-41320-200)

**OEM # C4SZ-21801-63C set . . . . . 5.95**



## Door Latch Assembly

1962-64 Fairlane

(Stock # B21-41325-025) - right hand

**OEM # C3OZ-21812-62A each . . . . . 84.95**

(Stock # B21-41330-025) - left hand

**OEM # C3OZ-21813-62A each . . . . . 84.95**



## Door Latch Assembly

1965 Fairlane

(Stock # S21-41325-035) - right hand

**OEM # C4SZ-21812-63C each . . . 54.95**

(Stock # S21-41330-035) - left hand

**OEM # C4SZ-21813-63C each . . . 54.95**



## Door Latch Assembly

1966 Fairlane

(Stock # B21-41325-040) - right hand

**OEM # C6OZ-21812-62A each . . . . . 91.95**

(Stock # B21-41330-040) - left hand

**OEM # C6OZ-21813-62A each . . . . . 91.95**



## Door Latch Assembly

1967 Fairlane

(Stock # B21-41325-045) - right hand

**OEM # C7OZ-21812-62A each . . . . . 69.95**

(Stock # B21-41330-044) - left hand

**OEM # C7OZ-21813-62A each . . . . . 69.95**

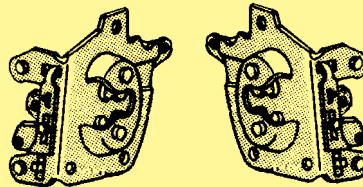

## Door Latch Assembly

1969-70 Fairlane/Torino

(Stock # P21-41325-050) - right hand

**OEM # C9AZ-21812-62A each. . . . . 79.95**

(Stock # P21-41330-060) - left hand

**OEM # C9AZ-21813-62A each. . . . . 79.95**



## Door Latch Repair Kit

Used when metal around the screws is broken. Can be cut to fit the 1969-70 Fairlane.

1967-68 Fairlane

(Stock # B21-41325-085)

**OEM # C7OZ-21812/3-RK kit . . . 25.95**

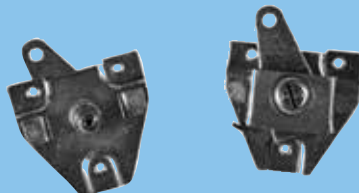

## Door Handle Shaft

For front or rear doors.

1966-67 Fairlane/Comet

(Stock # B21-41340-025) - right hand

**OEM # C6OZ-21818-62B each. . . 17.95**

(Stock # B21-41345-005) - left hand

**OEM # C6OZ-21819-62B each. . . 17.95**



## Door Lock Knob

1962 Fairlane - Chrome

(Stock # P21-41360-016) - .54" diameter at top

**OEM # C1VB-21850-57A each . . 17.95**

1962 Fairlane - Black

(Stock # P21-41360-011)

**OEM # B7A-21850-70A each . . . . 9.95**



## Door Lock Knob

1965 Fairlane

(Stock # X21-41360-025)

**OEM # C5DZ-21850-62A each. . . . 2.95**

1966-67 Fairlane

(Stock # P21-41360-020)

**OEM # C5AZ-21850-62A each. . . . 2.95**

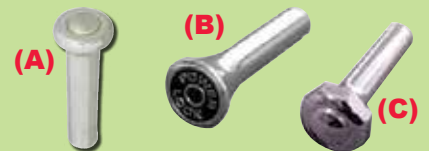

## Door Lock Knobs

1968-71 Fairlane/Torino - chrome

(Stock # P21-41360-030)

**OEM # C8AZ-21850-62A each. . . . 2.95**

1972-78 Torino - chrome - Power Lock

(Stock # P21-41360-035)

**OEM # D2AZ-21850-65A each . . 13.95**

1973-78 Torino - chrome - hex head

(Stock # B21-41360-040)

**OEM # D5OZ-21850-65B each . . . 5.95**



## Door Lock Sleeve Nut

Nylon door lock push button rod sleeve nut.

1965 Fairlane

(Stock # PC3-76545)

**OEM # C2AZ-377647-S each . . . . 1.95**

**Friend us on Facebook and follow us on Twitter. You never know what you might be in for.**

# 1962-72 Fairlane

Door & Window Parts



## Door Latch Rod Retainer

1964-65 Fairlane - from 3-1-64  
(Stock # P21-41420-010) **(A)**  
**OEM # C3AZ-21952-62A** each . . . . .95  
 1965-72 Fairlane/Comet  
(Stock # P21-41420-015) **(B)**  
**OEM # C5AZ-21952-62A** each . . . . .6.95  
 1965-71 Fairlane and Torino  
 1966-70 Comet and Montego  
(Stock # P21-41430-010) **(C)**  
**OEM # C5AZ-21954-62A** each . . . . .6.95



## Door Lock Lever Rod

1962-64 Fairlane  
(Stock # B21-41445-075) - fits either side  
**OEM # C2OZ-21970-62A** each . . . 18.95



## Door Lock Cylinder and Keys

Keys and retainer included  
 1967-72 Fairlane - does one side  
(Stock # P21-41455-050)  
**OEM # D2AZ-21984-65A** set . . . . .14.95



**Our standard ground service is shipped by FedEx. If you desire another carrier, let us know when you place your order, and we'll get you the details.**



## Door Lock Knob Grommet

1962-64 Fairlane  
 1962-63 Meteor  
(Stock # B21-41465-020) - black plastic **(A)**  
**OEM # C2OZ-21999-62B** each . . . . .4.95  
 1962-64 Fairlane  
(Stock # B21-41465-025) - chrome plastic  
**OEM # C2OZ-21999-62CC** each . . . 7.95  
 1965-67 Fairlane  
(Stock # P21-41465-045) - clear plastic  
**OEM # C5AZ-21999-62A** each . . . . .2.95  
 1968-70 Fairlane  
(Stock # S21-41465-060) - stainless steel **(B)**  
**OEM # C7SZ-21999-65B** each . . . 12.95  
 1970-72 Fairlane and Torino  
(Stock # P21-41465-065) - stainless steel **(C)**  
**OEM # D0AZ-21999-62A** each . . . 10.95

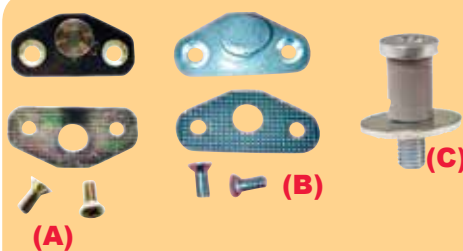

## Striker Plate and Shim

Complete with locking teeth and mounting screws.  
 1962-65 Fairlane  
(Stock # B22-42005-045) - either side **(A)**  
**OEM # C2OZ-22008-62B** each . . . 15.95  
 1966-71 Fairlane and Torino **(B)** Price Reduced!  
 1966-70 Comet and Montego  
(Stock # P22-42005-050) - either side  
**OEM # C5AZ-22008-62A** each . . . 14.95  
 1972 Fairlane **(C)**  
(Stock # P22-42005-060) - either side  
**OEM # D2AZ-22008-65A** each . . . 11.95



## Striker Plate Screws

Mounts striker to body. Set of 3.  
 1962-72 Fairlane  
 1966-70 Comet  
(Stock # P22-42005-075)  
**OEM # C0AZ-22008/9-62MB** set . . . . .1.95

**Online order is available 24/7!**  
[www.ClassicAutoParts.com](http://www.ClassicAutoParts.com)



## Door Latch Striker Anchor Plate Retainer

1966 Fairlane  
 1968-69 Montego  
 1968-70 Fairlane  
(Stock # P22-42035)  
**OEM # D0AZ-22021-62A** each . . . . .28.95



## Door Lock Cylinder Retainer

1966-71 Fairlane and Torino  
 1966-70 Comet and Montego  
(Stock # P22-42040-020)  
**OEM # C5AZ-22023-62A** each . . . . .1.95



## Ignition and Door Lock Set

Complete with retainers and keys as shown  
 1962-64 Fairlane - except Station Wagon  
 1965 Fairlane - 2 door Sedan only  
(Stock # P22-42070-015)  
**OEM # C3AZ-22050-62B** set . . . . .22.95



## Ignition and Door Lock Set

Complete with retainers and keys as shown  
 1966-69 Fairlane/Torino/Ranchero  
(Stock # P22-42070-035)  
**OEM # C9AZ-22050-62A** set . . . . .19.95

**Call Us:**  
**1-800-654-3247**

# 1962-72 Fairlane



### Door and Ignition Lock Set

Complete with retainers and keys  
1970-72 Torino

(Stock # P22-42070-040)

**OEM # D2AZ-22050-65A set . . . 28.95**

**Price Reduced!**

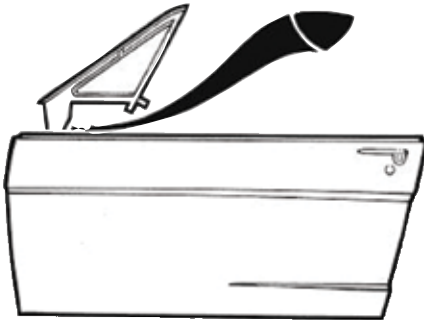

### Vent Window Frame to Door Seals

This is a special seal that glues on the vent window to stop water from leaking between the door and the vent window.  
1966-67 Fairlane/Comet - Hardtop and Convertible

(Stock # B22-42145)

**OEM # C6OZ-222A80-63A pair . . . 5.95**

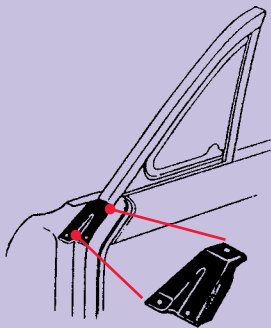

### Lower Vent Window Seals

Front of door seal at belt line in front of vent window.

1966-67 Fairlane and Comet - Hardtop and Convertible

(Stock # B22-42175)

**OEM # C6OZ-223A32-63A pair . . . . . 35.95**



### Rear Pillar Covers

Fit along pinchweld and underneath the scuff plates. Black - dye to match.

1970-71 Ranchero

(Stock # B22-42180)

**OEM # D0OZ-22342-62D pair . . 125.95**

**Price Reduced!**



### Outside Door Handle

Triple chrome plated - pads and buttons sold separately.

1962-64 Fairlane

(Stock # B22-42210-015) - right hand

**OEM # C2OZ-22404-62A each . . . . . 181.95**

(Stock # B22-42215-015) - left hand

**OEM # C2OZ-22405-62A each . . . . . 181.95**



### Outside Door Handle

Triple chrome plated - pads and buttons sold separately.

1966-71 Fairlane/Ranchero

1966-67 Comet

1968-71 Montego - front or rear doors

(Stock # B22-42210-045) - right hand **Price Reduced!**

**OEM # C6OZ-22404-62A each . . . . . 59.95**

(Stock # B22-42215-045) - left hand **Price Reduced!**

**OEM # C6OZ-22405-62A each . . . . . 59.95**



### Outside Door Handle Pads

1962-64 Fairlane

(Stock # B22-42230-090)

**OEM # C2OZ-22428-62S set . . . . . 7.95**

1965 Fairlane

(Stock # P22-42230-096)

**OEM # C5AZ-22428-62 set . . . . . 13.95**

1966-71 Fairlane, Torino and Montego

1968-70 Comet

(Stock # B22-42230-100)

**OEM # C6OZ-22428-62K set . . . . . 5.95**



### Door Handle Button

1966-71 Fairlane and Ranchero

1966-67 Comet

1967-71 Montego

(Stock # B22-42245-045) - fits either side

**OEM # C6OZ-22454-62B kit . . . . 23.95**

**Price Reduced!**



### Inside Door Handle

Triple chrome plated - die cast

1962-63 Fairlane

(Stock # P22-42270-035)

**OEM # C0AZ-22600-64A each . . . 24.95**



### Inside Door Handle

Triple chrome plated - die cast

1964-65 Fairlane

(Stock # P22-42270-040)

**OEM # C3AZ-22600-62B each . . . 9.95**



### Inside Door Handle

Die Cast - Chrome Plated

1966-67 Fairlane - except Hardtop and Convertible

(Stock # P22-42270-050)

**OEM # C5ZZ-22600-65C each . . . 7.95**



### Inside Door Handle

Die Cast - Chrome Plated

1966-67 Fairlane Hardtop and Convertible

(Stock # P22-42270-055) - right hand

**OEM # C7AZ-22600-54B each . . . 19.95**

(Stock # P22-42275-015) - left hand

**OEM # C7AZ-22601-54B each . . . 19.95**

*Check our prices on-line!  
See our website for current pricing.*

**Don't forget to join our e-mail list. We send out e-mail specials, and don't want you to miss out!**

# 1962-72 Fairlane



## Inside Door Handle

Die cast - chrome plated  
1968-69 Fairlane and Comet  
(Stock # P22-42270-065) - **right hand**

**OEM # C8AZ-22600-62B each . . . 19.95**

(Stock # P22-42275-020) - **left hand**

**OEM # C8AZ-22601-62B each . . . 19.95**



## Inside Door Handle Set

Die cast - chrome plated  
1970-71 Fairlane and Torino  
(Stock # P22-42270-074)

**OEM # D1AZ-22600/1-65A pair . . . .129.95**



## Inside Door Handle and Window Crank Screws

1962-72 All  
(Stock # P22-42270-030)

**OEM # C0AZ-22600-62K kit . . . . 4.95**



## Inside Door Handle Retainer Clip

1962-72 All  
(Stock # P22-42275) **(A)**

**OEM # 8A-22601-70A each . . . . . 0.00**

1962-72 All  
(Stock # P22-42275-005) **(B)**

**OEM # 8A-22601-70B each . . . . . 0.95**

**We accept these MAJOR credit cards.**



## Front Door Inside Handle Escutcheon

1962-64 Fairlane

(Stock # X22-42305) - **red**

**OEM # C1DB-22620-64A each . . . 9.95**

(Stock # B22-42305-020) - **green**

**OEM # C3OZ-22620-62C each . . . 7.95**

(Stock # B22-42305-025) - **beige**

**OEM # C3OZ-22620-62D each . . . 9.95**

(Stock # B22-42305-030) - **turquoise**

**OEM # C3OZ-22620-62E each . . . 9.95**

(Stock # C22-42305-040) - **palomino**

**OEM # C4DZ-22620-62A each . . . 9.95**



## Door Handle Cup

1968-69 Fairlane

(Stock # P22-42320) - **black**

**OEM # C8AZ-22634-62A1A each . . . . 9.95**

(Stock # P22-42320-005) - **dark blue**

**OEM # C8AZ-22634-62A1B each . . . . 13.95**

(Stock # P22-42320-010) - **red**

**OEM # C8AZ-22634-62A1D each . . . . 13.95**

(Stock # P22-42320-015) - **dark parchment**

**OEM # C8AZ-22634-62A2U each . . . . 9.95**



## Deluxe Door Hinge Repair Kit

Includes two hinge pins, four bushings, springs, check plate and plate pin, stop pin and bushing. Does upper and lower on one side.

1965 Fairlane

(Stock # P22-42322-033)



**OEM # C5ZZ-22780-65DK each . . 29.95**

**Check out our website for information, and to check on current prices!**



## Door Hinge Bushing

1962-70 Fairlane

1967-72 Fairlane and Torino - Convertible

1966-70 Comet and Montego

(Stock # P22-42350-005)

**OEM # C3AZ-22841-54B each . . . . 1.95**

1971-72 Fairlane

(Stock # P22-42350-01)

**OEM # D1AZ-22841-65A each . . . 0.00**



## Vent Window Handle Set

Die cast - chrome plated. Complete with washers and pins.

1962-65 Fairlane

(Stock # B22-42360-067)

**OEM # C3OZ-22916/7-62A set . . 24.95**



## Vent Window Handle Set

Die cast - chrome plated. Complete with washers and pins.

1966-67 Fairlane and Comet

(Stock # B22-42360-070)

**OEM # C6OZ-22916/7-63A set . . 26.95**

**Price Reduced!**



## Vent Window Handle Set

Die cast - chrome plated. Complete with washers and pins.

1968-69 Fairlane - all body styles

1968-71 Station Wagon

1968-70 Comet and Montego

(Stock # B22-42360-073)

**OEM # C8OZ-22916/7-54B set . . 32.95**

**For our International customers, we do offer a wire transfer for ordering. Inquire via phone or e-mail.**

# 1962-72 Fairlane

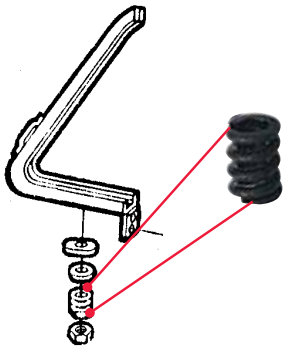

### Window Vent Pivot Spring

1962-71 Fairlane  
1966-70 Comet and Montego  
(Stock # P22-42385)  
**OEM # B5A-22926-70A each . . . . 4.95**

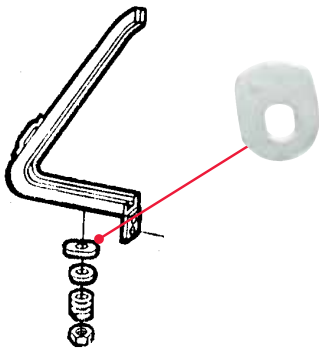

### Vent Window Pivot Stop

1966-68 Fairlane  
1968-69 Fairlane - 4 door Sedan  
1967-71 Fairlane - Station Wagon  
1966-67 Comet - all  
1968-71 Comet and Montego - Station Wagon  
(Stock # B22-42425)  
**OEM # C6OZ-22992-62A each . . 24.95**



### Door Bumper

1962-65 Fairlane - goes on door at lock  
1966-67 Fairlane and Comet - except Station Wagon - goes on rear of door  
1968-71 Fairlane and Comet - Station Wagon - goes on rear of door  
(Stock # P23-43015-015)  
**OEM # C2AZ-23030-62A each. . . . 0.95**

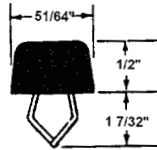

### Door Bumpers

Fits on rear of door at lock.  
1962 Meteor - 2 or 4 door Sedan  
1962-63 Fairlane - 2 door Sedan and Hardtop  
1964 Fairlane - 2 door Sedan and Hardtop  
(Stock # B23-43015-025)  
**OEM # C2OZ-23030-62A pair . . . . 6.95**



### Upper Door Bumper

Front and rear doors.  
1968-69 Fairlane  
1972 Torino  
(Stock # S23-43015-040)  
**OEM # C7SZ-23030-65A each . . . . 2.95**



### Door Bumpers

Fits on the rear of the door just above the lock.  
1962-63 Meteor  
1962-64 Fairlane  
(Stock # B23-43020)  
**OEM # C2OZ-23036/7-62A pair . . . . 23.95**  
1963-65 Fairlane - 2 door Hardtop  
1963 Meteor - 2 door Hardtop  
(Stock # B23-43020-005)  
**OEM # C3OZ-23036/7-65A pair . . . . 19.95**



### Upper and Lower Door Bumper

1968-72 Fairlane and Torino  
1968-70 Comet and Montego  
(Stock # P26-46020-020) - set of 4  
**OEM # C7AZ-265A28-54AA set. . . . . 0.95**



### Door Bumper

Fits on door jamb where rear of door closes against body and on rear lower part of door.  
(Stock # PC3-76500-005) - 7/16" high Price Reduced!  
**OEM # C0AZ-372164/5 pair . . . . 5.95**  
(Stock # PC3-76505) - 5/8" high  
**OEM # C0AZ-372167-L pair. . . . . 4.95**



### Door Window Regulator Scissors

1965 Fairlane - 2 door Hardtop  
(Stock # B23-43050-200) - right hand  
**OEM # C5ZZ-23234-65A each . . . 44.95**  
(Stock # B23-43060-100) - left hand  
**OEM # C5ZZ-23235-65A each . . . 44.95**



### Window Regulator Roller Arm

1962-65 Fairlane  
1962-63 Meteor  
(Stock # P23-43070-005)  
**OEM # C0AB-23240-64B each . . . 1.95**



### Window Regulator Roller Clip

1962-72 All  
(Stock # P23-43075)  
**OEM # BA-23241-70A each. . . . . 0.95**

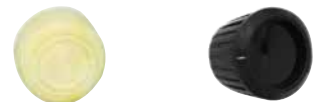

### Window Crank Knob

1962 Fairlane  
(Stock # X23-43105-020) - white  
**OEM # C0DB-23341-70B each . . . 7.95**  
1962-63 Fairlane  
(Stock # P23-43105-015) - black  
**OEM # C0AZ-23341-70B each. . . . 7.95**

# 1962-72 Fairlane

Door & Window Parts



### Complete Power Door Kit

Our complete power door kit has everything you need for two doors. Each kit includes our 3 function remote, power actuators, medium bear claw latches, and adjustable door rods.

**PDK 01** ..... **419.95**



### Power Bear Claw Door Shaved Door Handle Kit

Comes complete with right and left Power Bear Claw latches, Rocky Hinge's 3-function Keyless Entry System, wiring harness and easy to read instructions.

**SDP 01** ..... **345.95**



### Shaved Door Handle Kit with Solenoids

Our heavy duty shaved door handle kit comes complete with two high powered 60 lb. solenoids and a 3 channel keyless entry that will operate two doors and a trunk. Also included is our wiring harness with relay pack that has built-in safety feature to prevent the doors from accidentally being opened while the vehicle is running.

**SDH 01** ..... **345.95**



### Power Window Kit

Equipped with Bosch electric motors, these center lift power window kits are the smoothest available. Their compact design makes installation easy with no welding required. Each deluxe kit contains a left and right window regulator, two bottom window channels, complete wiring harness with crossover wiring, lighted window switches, and an installation guide. Priced in pairs.

**PWK 001** ..... **318.95**



### Power Window Switches

These switches use your original handles or aftermarket handles to operate your power windows. No relays required. Priced per pair available in 3/8" or 5/16" square shafts. Please specify size when ordering.

**PWS 01** ..... **193.95**



### Three Function Keyless Entry

This three function keyless entry system opens two doors and a trunk. Each kit contains 2 transmitters, receiver, and wiring.

**2RTA 01** ..... **112.95**

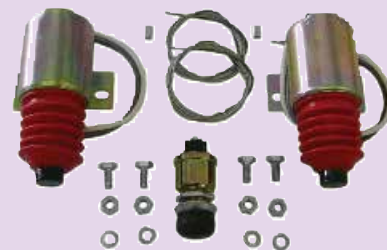

### Heavy Duty Solenoids

Tested at 40 lbs pull our solenoids work great with original door latches. Kit comes complete with 2 solenoid, 18" stainless cable, emergency override switch, one water proof button, instructions and all mounting hardware.

**HSB 01** ..... **165.95**

### Seven Function Keyless Entry

This 7 function keyless entry will roll your power windows up and down or lock and unlock your doors. It will also operate a power trunk. Kit includes two four button key fobs, four relays, wiring harness and instructions.

**7RTA 01** ..... **202.95**



# 1962-72 Fairlane

## POWER DOOR LOCK KITS



Door & Window Parts



### MES 4-Door Power Lock Kit

Comes with everything you need to convert your locks to power for all four doors.

**LK01-50-123.....177.95**



### MES 2-Door Power Door Lock Kit

MES door locks are Swiss made, and are original equipment on Ferrari, BMW, and Mercedes Benz. When you're looking for the best, specify MES.

**LK01-10-122.....119.95**



### Keyless Entry/Starter Disable System

The ELECTRIC-LIFE Keyless Entry/Alarm module comes with 4 programmable channels.

#### Features:

- 4 Programmable Channels
- 2-4 Button Transmitters
- Remote Panic (full time)
- Separate Lock & Unlock Buttons
- Starter Disable Output (built in relay)
- Channel Pulsed Output
- Sire / Horn Honk Output
- 3rd & 4th Channel Pulsed Ground / Variable Output
- Power Door Lock / Unlock Outputs
- Driver's Door Unlock Output

**95121.....73.95**

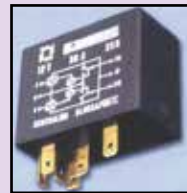

### Power Door Lock Module

The power lock module can be used to operate any reverse polarity motor. The module is triggered with (-) inputs, eliminating the need for multiple relays.

**3901-58-918.....35.95**



### Manual Door Locks to Power Remote

Convert your old manual door locks to full power remote with this kit. The combination power door lock and keyless entry system will convert your old manual locks to full remote power. Comes with 2-4 button transmitters that can activate your locks from 100 feet away.

**95120.....169.95**

**Please allow 7-14 days  
for Special Orders!**

# 1962-72 Fairlane

Door & Window Parts



## KEYLESS ENTRY & DOOR LOCK KITS



**MES 5 Wire Lock Actuator**  
 The most powerful trigger actuator available. This precision Swiss made actuator can pull an actual 12 lb. load and can operate any door lock. Comes complete with mounting hardware. Sold each.  
**4202-10-910 ..... 24.95**



**MES 2 Wire Lock Actuator**  
 The 2 wire MES actuator performs exactly like the 5 wire unit, and can be used to open door latches, hood latches or tailgate releases. Sold each.  
**4202-10-909..... 21.95**

**Power Bear Claw Latch Kit**  
 This is the ticket for an award winning street rod. This kit is complete with left and right Bear Claw latches, attached power actuators, and manual cable release to insure a safe exit in case of power loss.  
**94000. .... 167.95**

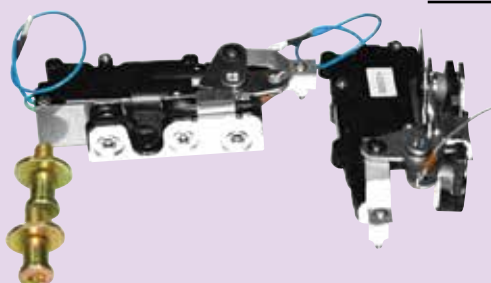

**50 Pound Door Solenoids**  
 99004 pair ..... 79.95  
 99003 each ..... 49.95



**Economy Shaved Door Handle Kit with 12 lb MES Actuators**  
 Our Economy Shaved Door Handle Kit uses all the same components as our heavy duty kit except that we use our 12 lb MES actuators in place of the 50 lb solenoids. This kit will pop any late model door or Bear Claw latch. For early model vehicles with heavy latches use the Heavy Duty Kit.  
**99002..... 174.95**



**Power Bear Claw Shaved Handle Kit**  
 Take that ride to the next level with our Power Bear Claw Shaved Handle Kit. Complete with left and right power bear claw latches, 4 channel keyless entry with two 4-button remotes and heavy duty plug and play wiring harness.  
**94100..... 359.95**

**Bear Claw Mounting Kit**  
 When installing one of our power Bear Claw kits, don't forget to order our mounting kit for the striker bolt. This kit greatly simplifies the installation process, and will make quick work of lining up the latch with the striker bolt.  
**94103..... 69.95**



**Please allow 7-14 days for Special Orders!**

# 1962-72 Fairlane

## SWITCHES & SWITCH KITS



Door & Window Parts



### Universal 2-Door Illuminated Console or Door Panel Mount Rocker Switch Kit

Complete with 3 switches, 1 double bezel, 1 single bezel, wiring harness and connectors.

**4990-10-142 ..... 69.95**



### GM Style 2-Door Chrome Switch Kit

Door panel mount - Kit comes complete with 1 double chrome switch pod, 1 single chrome switch pod and complete harness.

**4990-10-356 ..... 219.95**



### Universal 2-Door Illuminated Console or Door Panel Mount Rocker Switch Kit

Complete with 3 switches, 1 double bezel, 1 single bezel, wiring harness and connectors.

**4990-10-201 ..... 77.95**



### Door Panel Mount Switches

BMW Style Universal illuminated rocker switch kit. Comes complete with 3 switches, 1 raised double bezel, 1 raised single bezel, wiring harness and plug connectors.

**4980-31-009 ..... 74.95**

**Please allow 7-14 days for Special Orders!**



### Joker Universal 2-Door Illuminated Door Panel Mount Rocker Switch Lit

BMW style complete with 3 switches, 1 raised double bezel, 1 raised single bezel, wiring harness and plug connectors.

**4990-10-421 ..... 79.95**

## POWER WINDOW SYSTEMS



### 1963-65 Fairlane 2 Door Hardtop and Convertible Front

Kit comes complete with everything you need to convert two front doors. Switches and wiring harness are sold separately.

**FD54-6465-K ..... 405.95**



### 1963-65 Fairlane 2 Door Hardtop Rear Quarter

Kit comes complete with everything you need to convert two rear doors. Switches and wiring harness are sold separately.

**FD59-K ..... 317.95**

# 1962-72 Fairlane

Door & Window Parts



## Inside Window Crank Handle

Die cast, chrome plated - with black knob  
1963-65 Fairlane - will fit '64 but not original

(Stock # X23-43110-210)

**Price Reduced!**

**OEM # C4DZ-23342-63A each... 21.95**



## Inside Window Crank Handle

Die cast, chrome plated - with chrome knob

1965-67 Fairlane

(Stock # X23-43110-067)

**OEM # C5ZZ-23342-65C each... 10.95**



## Inside Window Crank Handle

Die cast, satin chrome plated - less knob

1968-69 Fairlane

(Stock # P23-43110-075)

**OEM # C8AZ-23342-62A each... 7.95**

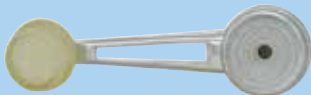

## Inside Window Crank Handle

Die cast, satin chrome plated - clear knob

1972 Torino

(Stock # B23-43110-085)

**OEM # D2OZ-23342-65A each... 29.95**

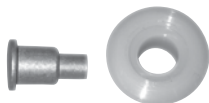

## Window Regulator Arm Roller

1965-71 Fairlane

(Stock # P26-46010-005)

**OEM # C5AZ-262A32-57A each... 2.95**



## Window Regulator Handle Screw Cover

1968-72 Fairlane and Comet

(Stock # P23-43130-005)

**OEM # C8AZ-23362-62A each... 1.95**



## Window Crank Knob with Pin

1968-72 Fairlane and Torino

1968-70 Comet and Montego

(Stock # P23-43125-011) - red

**OEM # C8AZ-23352-62A1D each... 7.95**

(Stock # P23-43125-030) - black

**OEM # C9AZ-23352-62A each... 3.95**

(Stock # P23-43125-050) - parchment

**OEM # D1AZ-23352-65D each... 3.95**

(Stock # P23-43125-060) - maroon

**OEM # D1AZ-23352-65F each... 5.95**

(Stock # S23-43125-080) - blue

**OEM # D1SZ-23352-65B each... 9.95**

(Stock # P23-43125-065) - ginger

**OEM # D1AZ-23352-65G each... 5.95**

(Stock # P23-43125-070) - green

**OEM # D1AZ-23352-65H each... 4.95**



## Door and Window Crank Handle Backing Plate

1962-63 Fairlane

(Stock # P23-43135)

**OEM # B7A-23370-70B each... 1.95**

1964 Fairlane

(Stock # P23-43135-005)

**OEM # C3AZ-23370-62A each... 1.95**

1966-67 Fairlane - front door, rear on Station Wagon and quarter window on Convertible and Hardtop

1966-67 Comet

(Stock # P23-43135-015)

**OEM # C5AZ-23370-62A each... 0.95**

1968-71 Fairlane

1968-72 Montego

(Stock # P23-43135-020)

**OEM # C8AZ-23370-62A each... 1.95**

**Price Reduced!**



## Electric Window Motor

1968-72 Fairlane and Torino

(Stock # P23-43140) - right hand

**Price Reduced!**

**OEM # D0AZ-23394-57A each... 72.95**

(Stock # P23-43145-005) - left hand

**Price Reduced!**

**OEM # D0AZ-23395-57A each... 59.95**



## Electric Window Motor Drive Gear

9 tooth drive gear with shock absorbing spring

1965-71 Fairlane and Torino - door and 1/4 window

1970 Station Wagon - tailgate

(Stock # P23-43165-005)

**OEM # D0AZ-234A24-62B each... 14.95**

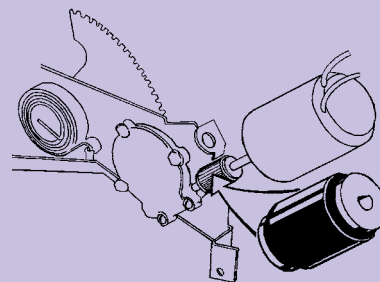

## Drive Coupling

For tailgate power lift windows.

1963-65 Fairlane - Station Wagon

(Stock # M23-43175-005)

**OEM # C1VB-23440-57A each... 17.95**



## Door Hinge Repair Rivet

1962 Fairlane

(Stock # X23-43220)

**OEM # C0DZ-23567-62 each... 1.00**



## Door Hinge Pin

Cut to length if needed.

1962-72 All

(Stock # P43-55065-005)

**OEM # B9A-43030-59AA each... 2.95**

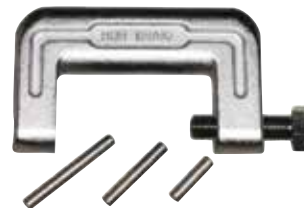

## Hinge Pin Puller

(Stock # 46-58100-040)

**OEM # X-46335-RT each... 29.95**

**Obsolete & Classic Auto Parts, Inc.**

# 1962-72 Fairlane



## 1963 Fairlane Door Panels

This interior soft trim was meticulously reproduced to match original. We start with correct crush grain vinyl in factory colors and have all the correct seat pleat patterns and door panel chrome mylar made exactly like original. These are beautifully done and sure to help you win the trophies. Available in black, red, two tone blue, and light gold.

1963 Fairlane Sport Coupe  
(Stock # B23-43280-333) - front

**OEM # C3OZ-23942/3-65B pair . . . .254.95**

(Stock # B30-50100-333) - rear

**OEM # C3OZ-31012/3-65B pair . . . .189.95**

## Seat Panel Board

These are the two small panel boards covered with vinyl located below your seat frames. They are die cut out of the original type panel board for exact fit and then we adhere your original color vinyl to the board to match the interior upholstery and door panels perfectly.

1963 Fairlane Sport Coupe  
(Stock # BB6-52700-010)

**OEM # C4AZ-67516/7-76 pair . . . 51.95**

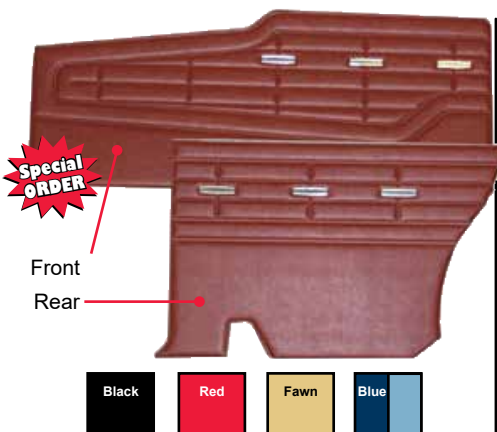

## 1964 Fairlane 500 Door Panels

This is the hard to find material that has not been offered up until now. We have accurately reproduced the interior to match original. Features correct crush grain vinyl, original dielectric embossed patterns in the seat covers and door panels. Door panels are die cut with correct perforations for door handles, armrest and window crank. Available colors: black, red, two tone blue and fawn.

1964 Fairlane 500 - Hardtop or Sedan  
(Stock # B23-43280-227) - front

**OEM # C4OZ-23942/3-500 pair . . . .399.95**

1964 Fairlane 500 - Hardtop

(Stock # B30-50100-034) - rear

**OEM # C4OZ-31012/3-63 pair . . . .224.95**

1964 Fairlane 500 - Sedan

(Stock # B30-50100-044) - rear

**OEM # C4OZ-31012/3-62 pair . . . .155.95**



## 1966-67 Door Panels

We make beautiful reproduction door panels to match our high quality interior upholstery. Door panels features original chrome rectangular trim, original grain vinyls, colors and correct heat formed design. An exact reproduction. Available colors: Aqua, Black, Blue Emberglow, Ivy Gold, Parchment, Red, Saddle, Lt Blue.

1966-67 Fairlane/Ranchero - XL, GT  
(Stock # B23-43280-253) - front

**OEM # C6OZ-23942/3-531 pair . . . .399.95**

1966-67 Fairlane XL, GT - Hardtop

(Stock #X30-50100-042) - rear

**OEM # C6OZ-31012/3-549 pair . . . .139.95**

1966-67 Fairlane XL, GT - Convertible

(Stock # X30-50100-047) - rear

**OEM # C6OZ-31012/3-556 pair . . . .139.95**

## 1966 Fairlane 500 Door Panels

This features the correct horizontal embossed seat pattern and the original sierra grain vinyl with walrus grain insert. The door panels have the original style woodgrain paneling and factory pattern.

Available colors: black, red, blue, aqua, ivy gold and parchment.

1966 Fairlane 500 - non GT or XL  
(Stock # B23-43280-777) - front

**OEM # C6OZ-23942/3-B5 pair . . . .219.95**

1966 Fairlane 500 Hardtop - non GT or XL

(Stock # B30-50100-777) - rear

**OEM # C6OZ-31012/3-63B pair . . . .219.95**

## NOTE:

All Door Panels are SPECIAL ORDER and NON Returnable. Please check and double check your information before ordering as these are shipped directly from the manufacturer to your door.

All are made to your specifications. Allow 10-14 days for delivery on all Special Order Items.

Save on shipping by watching for our Free Freight e-mails. You can join our e-mail club at [www.ClassicAutoParts.com](http://www.ClassicAutoParts.com)



## 1964 Fairlane Door Panels

All new door panels are made exactly as original in intricate detail featuring original Crush grain vinyl in factory colors. Correct chrome mylar outer band and chrome accent buttons and red lower door reflector as original. Available in black, red, white, palomino and two toned blue.

1964 Fairlane Sports Coupe  
(Stock # B23-43280-226) - front

**OEM # C4OZ-23942/3-465 pair . . . .399.95**

(Stock # B30-50100-034) - rear

**OEM # C4OZ-31012/3-473 pair . . . .149.95**

# 1962-72 Fairlane

Door & Window Parts



## 1967 Fairlane 500 Door Panel

1967 Fairlane 500 models can be very difficult to restore due to original soft trim scarcity. We are proud to introduce Concours quality soft trim that will make your car a show stopper. We have replicated the original seat patterns using sierra grain vinyl in original colors. Door panels also feature all correct dielectric pattern and have perforated window crank, door handle and armrest holes in the board.  
**Available colors: black, red, blue, aqua, and parchment.**

- 1967 Fairlane 500 2 door Sedan (Stock # B23-43280-277) - **front** Price Reduced!  
**OEM # C7OZ-23942/3-746 pair . . . .339.95**  
 (Stock # B30-50100-277) - **rear**  
**OEM # C7OZ-30102/3-62 pair . . . .155.95**  
 1967 Fairlane 500 Convertible (Stock # B30-50100-092) - **rear**  
**OEM # C7OZ-31012/3-747 pair . . . .224.95**



## 'GT' Door Panel Emblem

- 1966-67 Fairlane (Stock # B23-43280)  
**OEM # C6OZ-23942-63GTE pair . . . .55.95**

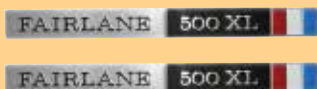

## 'XL' Door Panel Emblem

- 1966-67 Fairlane (Stock # B23-43280-005)  
**OEM # C6OZ-23942-63XLE pair . . . .44.95**



## 1968-69 Torino and Ranchero GT Front Door Panels

- Finally available are the exact reproduction door panels. Includes the beautiful chrome plated "Grand Touring" emblems. Features exact stitch bar heat sealed design and all factory color options. These panels DO NOT include the upper metal reinforcement or attaching weatherstrip. The door panel includes extra material which attaches directly over the original upper reinforcement metal trim. Corinthian grain vinyl with all holes die cut.
- 1968-69 Torino and Ranchero GT (Stock # B23-43280-295) - **aqua**  
**OEM # C8OZ-23942/3-66AQ pair . . .299.95**  
 (Stock # B23-43280-300) - **black**  
**OEM # C8OZ-23942/3-66BLK pair . .319.95**  
 (Stock # B23-43280-305) - **blue**  
**OEM # C8OZ-23942/3-66BLU pair . .299.95**  
 (Stock # B23-43280-310) - **ivy gold**  
**OEM # C8OZ-23942/3-66IG pair . . .299.95**  
 (Stock # B23-43280-315) - **nugget gold**  
**OEM # C8OZ-23942/3-66NG pair . . .299.95**  
 (Stock # B23-43280-320) - **red**  
**OEM # C8OZ-23942/3-66RD pair . . .299.95**  
 (Stock # B23-43280-325) - **white**  
**OEM # C8OZ-23942/3-66WH pair . .299.95**

## NOTE:

All Door Panels are **SPECIAL ORDER** and **NON Returnable**. Please check and double check your information before ordering as these are shipped directly from the manufacturer to your door.

All are made to your specifications. Allow 10-14 days for delivery on all Special Order Items.

## 1968-69 Torino Fastback Rear Door Panels

- Die cut, Corinthian grain vinyl. 1968-69 Torino GT Fastback (Stock # B30-50100-100) - **aqua** Special ORDER  
**OEM # C8OZ-31012/3-63A pair . . .125.95**  
 (Stock # B30-50100-105) - **black**  
**OEM # C8OZ-31012/3-63BLK pair . .154.95**  
 (Stock # B30-50100-110) - **blue**  
**OEM # C8OZ-31012/3-63BLU pair . .125.95**  
 (Stock # B30-50100-115) - **ivy gold**  
**OEM # C8OZ-31012/3-63IG pair . . .125.95**  
 (Stock # B30-50100-120) - **nugget gold**  
**OEM # C8OZ-31012/3-63NG pair . .125.95**  
 (Stock # B30-50100-125) - **red**  
**OEM # C8OZ-31012/3-63RD pair . . .125.95**  
 (Stock # B30-50100-130) - **white**  
**OEM # C8OZ-31012/3-63WH pair . .125.95**

## 1968-69 Torino Formal Roof Rear Door Panels

- Die cut, Corinthian grain vinyl. 1968-69 Torino GT - formal roof (Stock # B30-50100-135) - **aqua** Special ORDER  
**OEM # C8OZ-31012/3-65A pair . . .154.95**  
 (Stock # B30-50100-140) - **black**  
**OEM # C8OZ-31012/3-65BLK pair . .161.95**  
 (Stock # B30-50100-145) - **blue**  
**OEM # C8OZ-31012/3-65BLU pair . .161.95**  
 (Stock # B30-50100-150) - **ivy gold**  
**OEM # C8OZ-31012/3-65IG pair . . .161.95**  
 (Stock # B30-50100-155) - **nugget gold**  
**OEM # C8OZ-31012/3-65NG pair . .161.95**  
 (Stock # B30-50100-160) - **red**  
**OEM # C8OZ-31012/3-65RD pair . . .161.95**  
 (Stock # B30-50100-165) - **white**  
**OEM # C8OZ-31012/3-65WH pair . .161.95**

## 1968-69 Torino Convertible Rear Door Panels

- Die cut, Corinthian grain vinyl. 1968-69 Torino GT Convertible (Stock # B30-50100-170) - **aqua** Special ORDER  
**OEM # C8OZ-31012/3-76A pair . . .125.95**  
 (Stock # B30-50100-175) - **black**  
**OEM # C8OZ-31012/3-76BLK pair . . .99.95**  
 (Stock # B30-50100-180) - **blue**  
**OEM # C8OZ-31012/3-76BLU pair . .125.95**  
 (Stock # B30-50100-185) - **ivy gold**  
**OEM # C8OZ-31012/3-76IG pair . . .125.95**  
 (Stock # B30-50100-190) - **nugget gold**  
**OEM # C8OZ-31012/3-76NG pair . . .125.95**  
 (Stock # B30-50100-195) - **red**  
**OEM # C8OZ-31012/3-76RD pair . . .125.95**  
 (Stock # B30-50100-200) - **white**  
**OEM # C8OZ-31012/3-76WH pair . .125.95**

Call Us:

1-800-654-3247

# 1962-72 Fairlane

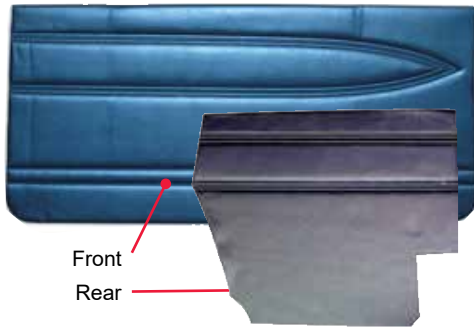

Front  
Rear



## 1970 GT Door Panels

Our reproduction 1970 Torino GT door panels are made with the original spear heat sealed design and factory Corinthian vinyls in all original colors. These are designed to reuse your original aluminum spear which can be removed and re-placed on your new door panel. Used on Torino GT models only!

Available colors: black, blue, maroon, white, ginger, ivy green

1970 Torino GT

(Stock # B23-43280-675) - front

OEM # D00Z-23942/3-65 pair . . . . .399.95

1970 Torino GT Fastback

(Stock # B30-50100-675) - rear

OEM # D00Z-31012/3-63 pair . . . . .111.95

1970 Torino GT Convertible

(Stock # B30-50100-676) - rear

OEM # D00Z-31012/3-76 pair . . . . .83.95

## NOTE:

All Door Panels are SPECIAL ORDER and NON Returnable. Please check and double check your information before ordering as these are shipped directly from the manufacturer to your door.

All are made to your specifications. Allow 10-14 days for delivery on all Special Order Items.

**We love when our customers bring their cars and trucks by. Feel free to drive yours up and show it off.**



Front  
Rear



## 1970-71 Torino Standard Front Door Panels

Finally available are the exact reproduction door panels. Includes the beautiful chrome plated "Grand Touring" emblems. Features exact stitch bar heat sealed design and all factory color options. Corinthian vinyl with factory chrome mylar strip.

1970-71 Torino standard

1970-71 Ranchero GT, 500 and Squire

(Stock # B23-43280-345) - black

OEM # D00Z-23942/3-66BLK pair . .239.95

(Stock # B23-43280-350) - blue

OEM # D00Z-23942/3-66BLU pair . .239.95

(Stock # B23-43280-355) - ginger

OEM # D00Z-23942/3-66GNG pair .239.95

(Stock # B23-43280-360) - ivy gold

OEM # D00Z-23942/3-66IG pair . . .239.95

(Stock # B23-43280-365) - red

OEM # D00Z-23942/3-66RD pair . . .239.95

(Stock # B23-43280-370) - white

OEM # D00Z-23942/3-66WHT pair .239.95

## 1970-71 Torino and Ranchero Rear 1/4 Trim Panels

Correct heat sealed design in Corinthian vinyl with factory chrome mylar strip.

1970-71 Torino Formal Roof and Ranchero

(Stock # B30-50100-235) - black

OEM # D00Z-31012/3-65BLK pair . .118.95

(Stock # B30-50100-240) - blue

OEM # D00Z-31012/3-65BLU pair . .159.95

(Stock # B30-50100-245) - ginger

OEM # D00Z-31012/3-65GNG pair .118.95

(Stock # B30-50100-250) - ivy gold

OEM # D00Z-31012/3-65IG pair . . .118.95

(Stock # B30-50100-255) - red

OEM # D00Z-31012/3-65RD pair . . .118.95

(Stock # B30-50100-260) - white

OEM # D00Z-31012/3-65WHT pair .118.95

## 1970-71 Torino Rear 1/4 Trim Panels

Correct heat sealed design in Corinthian vinyl with factory chrome mylar strip.

1970-71 Torino Fastback

(Stock # B30-50100-205) - black

OEM # D00Z-31012/3-63BLK pair . .118.95

(Stock # B30-50100-210) - blue

OEM # D00Z-31012/3-63BLU pair . .118.95

(Stock # B30-50100-215) - ginger

OEM # D00Z-31012/3-63GNG pair .118.95

(Stock # B30-50100-220) - ivy gold

OEM # D00Z-31012/3-63IG pair . . .118.95

(Stock # B30-50100-225) - red

OEM # D00Z-31012/3-63RD pair . . .118.95

(Stock # B30-50100-230) - white

OEM # D00Z-31012/3-63WHT pair .118.95



# 1962-72 Fairlane



## 1971 GT Door Panels

Our new door panel features chrome spear with black padded insert. We feature all original colors and correct stitch design on the panel. Color matched to our interiors!

Available colors: black, blue, dark ivy, ginger, maroon, white.

1971 Torino GT and Ranchero GT  
(Stock # B23-43280-775) - front

OEM # D10Z-23942/3-63 pair . . . . .349.95

1971 Torino GT Fastback  
(Stock # B30-50100-775) - rear

OEM # D10Z-31012/3-63 pair . . . . .154.95

1971 Torino GT Convertible  
(Stock # B30-50100-776) - rear

OEM # D10Z-31012/3-76 pair . . . . .125.95

## NOTE:

All Door Panels are SPECIAL ORDER and NON Returnable. Please check and double check your information before ordering as these are shipped directly from the manufacturer to your door.

All are made to your specifications. Allow 10-14 days for delivery on all Special Order Items.

Check out our Swap Meet Schedule to see when we will be in your area. Maybe even save some on shipping. Call one of the guys for more information!

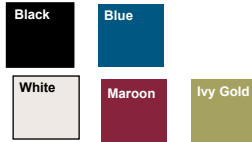

## 1972 Torino Front Door Panels

Finally available are the exact reproduction door panels. Includes the beautiful chrome plated "Grand Touring" emblems. Features exact stitch bar heat sealed design and all factory color options. Corinthian grain vinyl.

1972 Torino - formal roof

1972 Ranchero 500 and Squire  
(Stock # B23-43280-400) - black

OEM # D20Z-23942/3-66BLK pair . .248.95

(Stock # B23-43280-405) - blue

OEM # D20Z-23942/3-66BLU pair . .299.95

(Stock # B23-43280-410) - ivy gold

OEM # D20Z-23942/3-66IG pair . . .299.95

(Stock # B23-43280-415) - maroon

OEM # D20Z-23942/3-66MAR pair .299.95

(Stock # B23-43280-420) - white

OEM # D20Z-23942/3-66WHT pair .299.95

## 1972 Gran Torino Rear Door Panels

Finally available are the exact reproduction door panels. Includes the beautiful chrome plated "Grand Touring" emblems. Features exact stitch bar heat sealed design and all factory color options. Corinthian grain vinyl.

1972 Torino - formal roof

(Stock # B23-43280-375) - black

OEM # D20Z-23942/3-65BLK pair . .119.95

(Stock # B23-43280-380) - blue

OEM # D20Z-23942/3-65BLU pair . .118.95

(Stock # B23-43280-385) - ivy gold

OEM # D20Z-23942/3-65IG pair . . .111.95

(Stock # B23-43280-390) - maroon

OEM # D20Z-23942/3-65MAR pair . . .0.00

(Stock # B23-43280-395) - white

OEM # D20Z-23942/3-65WHT pair .118.95



## 1962-64 Arm Rest Pads

Standard armrest pad used on all models except vehicles with deluxe interior. An exact reproduction features original grain. For standard models only. 9" long  
1962-64 Fairlane

Red

(Stock # X24-44010-065) - right hand

OEM # C3DZ-24140-ACB . . . . . 31.95

(Stock # X24-44015-075) - left hand

OEM # C3DZ-24141-ACB . . . . . 39.95

Palomino

(Stock # P24-44010-006) - right hand

OEM # B9A-24140-62P . . . . . 59.95

(Stock # P24-44015-016) - left hand

OEM # B9A-24141-62P . . . . . 59.95



## 1963-64 Deluxe Arm Rests

Correct 1963/1964 Fairlane deluxe model armrest pads are an exact replica of the original Ford. Features correct grain texture and original fit and finish. Durable padded armrest molded in black, red, blue, white, and palomino. 10 1/4" long  
1963-64 Fairlane - Deluxe

Black

(Stock # B24-44010-080) - right hand

OEM # C40Z-24140-62A each . . 35.95

(Stock # B24-44015-080) - left hand

OEM # C40Z-24141-62A each . . 54.95

Red

(Stock # B24-44010-085) - right hand

OEM # C40Z-24140-62R each . . 64.95

(Stock # B24-44015-090) - left hand

OEM # C40Z-24141-62R each . . 64.95

Blue

(Stock # B24-44010-555) - right hand

OEM # C40Z-24140-62BL each . . 59.95

(Stock # B24-44015-555) - left hand

OEM # C40Z-24141-62BL each . . 59.95

White

(Stock # B24-44010-556) - right hand

OEM # C40Z-24140-62W each . . 51.95

(Stock # B24-44015-556) - left hand

OEM # C40Z-24141-62W each . . 35.95



Call Us:

1-800-654-3247

# 1962-72 Fairlane



## 1965-66 Arm Rests

Correct reproduction of the original Ford® part. This is the thirteen inch style that mounts into the original plastic base. These are a foam filled part and are flexible like the original Ford® yet very durable. Please verify your armrest size before ordering. Available in black, red and blue.

1965-66 Fairlane  
1966 Comet

12½" long

(Stock # B24-44010-120) - black

**OEM # C6OZ-24140-62B1A** each . . . .64.95

(Stock # B24-44010-130) - blue

**OEM # C6OZ-24140-62B1C** each . . . .64.95

(Stock # B24-44010-125) - red

**OEM # C6OZ-24140-62B1B** each . . . .57.95

9" long

(Stock # B24-44010-110) - red

**OEM # C6OZ-24140-62A1B** each . . . .57.95

(Stock # B24-44010-115) - blue

**OEM # C6OZ-24140-62A1C** each . . . .77.95

(Stock # P24-44010-116) - palomino

**OEM # C6OZ-24140-62A1D** each . . . .64.95



## Molded Arm Rest

This accurate reproduction of the 1967 Fairlane arm rest pad features correct simulated stitch and original sierra grain texture. This part is molded with the original soft padded feel with greater durability than original. Available in original black, red, and blue to match your interior. Made in the USA!

9¼" long

1967 Fairlane and Ranchero - non GT  
1967 Comet

(Stock # B24-44010-135) - black

**OEM # C7OZ-24140-62A1A** each . . . .36.95

(Stock # B24-44010-140) - red

**OEM # C7OZ-24140-62A1B** each . . . .47.95

(Stock # B24-44010-145) - blue

**OEM # C7OZ-24140-62A1C** each . .59.95.95

**I do not believe a man can ever leave his business. He ought to think of it by day and dream of it by night.**

~ Henry Ford



## 1967 Arm Rest Pad

This accurate reproduction of the 1967 Fairlane arm rest pad features correct simulated stitch and original sierra grain texture. This part is molded with the original soft padded feel with greater durability than original. These will fit either side.

12¼" long

1967 Fairlane/Ranchero - XL, GT and Comet

(Stock # B24-44010-150) - black

**OEM # C7OZ-24140-62B1A** each . . . .54.95

(Stock # B24-44010-155) - red

**OEM # C7OZ-24140-62B1B** each . . . .47.95

(Stock # B24-44010-160) - blue

**OEM # C7OZ-24140-62B1C** each . . . .59.95



## 1967 Rear Arm Rest Pads

These are designed to mount into the stock armrest base and feature correct Sierra grain and padded feel as original. These parts are better than the original and are made right here in the USA!

1967 Fairlane

Black

(Stock # B27-47010-555) - right hand

**OEM # C7OZ-27540-62B** each. . . 45.95

(Stock # B27-47015-555) - left hand

**OEM # C7OZ-27541-62B** each. . . 63.95

Red

(Stock # B27-47010-556) - right hand

**OEM # C7OZ-27540-62R** each. . . 34.95

(Stock # B27-47015-556) - left hand

**OEM # C7OZ-27541-62R** each. . . 34.95



## Molded Arm Rest

Exact reproduction of the original. Fits the front door. 15¼" long

1968-69 Torino and Ranchero

1968-69 Montego

Black

(Stock # B24-44010-165) - right hand

**OEM # C8OZ-24140-65A1A** each . . . .64.95

(Stock # B24-44015-120) - left hand

**OEM # C8OZ-24141-65A1A** each . . . .64.95

Red

(Stock # P27-47010) - right hand

**OEM # C8AZ-27540-54A2D** each . . . .47.95

(Stock # P27-47015) - left hand

**OEM # C8AZ-27541-54A2D** each . . . .47.95



## 1968-69 Rear Arm Rest Pads

These are designed to mount into the stock armrest base and feature correct Sierra grain and padded feel as original. These parts are better than the original and are made right here in the USA!

1968-69 Fairlane/Torino

(Stock # B27-47010-655) - black

**OEM # C8OZ-27540-62B** each. . . . 0.00

(Stock # B27-47010-656) - white

**OEM # C8OZ-27540-62W** each . . 52.95



## 1970 Arm Rest Pad

Exact reproduction of the original. Fits the front door. 8½" long

1970 Torino/Ranchero and Montego

1970-79 Torino - rear door also

(Stock # B24-44010-180) - black

**OEM # D0OZ-24140-66A** each . . 35.95

(Stock # B24-44010-185) - blue

**OEM # D0OZ-24140-66B** each . . . 34.95

**We accept these MAJOR credit cards.**



**1-800-654-3247**  
**Call Us for**  
**All-American**  
*Deals*

# 1962-72 Fairlane

Door & Window Parts



## 1971-79 Door Arm Rests

Correct texture and molded in colors with steel insert moulded into the foam to increase strength. Extra thick vinyl skins.

1971-79 Torino and Ranchero  
1971-76 Montego

**Black**

(Stock # P24-44010-196) - right hand

**OEM # D1ZZ-24140-65BLK each . . . . 24.95**

(Stock # P24-44015-142) - left hand

**OEM # D1ZZ-24141-65BLK each . . . . 11.95**

**Blue**

(Stock # P24-44010-197) - right hand

**OEM # D1ZZ-24140-65BLU each . . . . 27.95**

(Stock # P24-44015-143) - left hand

**OEM # D1ZZ-24141-65BLU each . . . . 29.95**

**Ginger**

(Stock # P24-44010-198) - right hand

**OEM # D1ZZ-24140-65GIN each . . . . 29.95**

(Stock # P24-44015-144) - left hand

**OEM # D1ZZ-24141-65GIN each . . . . 28.95**

**White**

(Stock # B24-44000-005) - right hand

**OEM # D1OZ-24100-65E each . . . . . 35.95**

(Stock # B24-44005-005) - left hand

**OEM # D1OZ-24101-65E each . . . . . 35.95**



## Arm Rest Base

Black - paint to match. Fits either side.

1971-79 Torino and Ranchero  
1971-76 Montego

(Stock # P24-44006-300)

**OEM # D1ZZ-24144-65A each . . . 14.95**

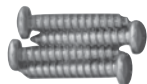

## Arm Rest Screws

Base to door panel screws

1962-72 Fairlane and Comet

(Stock # P24-44010-015) - set of 4

**OEM # COAZ-24140-62K set . . . . . 3.95**



**Friend us on Facebook and follow us on Twitter. You never know what you might be in for.**



## 1972-73 Door Arm Rest

This is the long armrest used on molded door panels only. Sold per side. **19½" long**

1972-73 Gran Torino Sport  
1972-73 Ranchero GT  
1972-73 Montego GT

**Black**

(Stock # B24-44010-205) - right hand

**OEM # D2OZ-24140-65A each . . 41.95**

(Stock # B24-44015-150) - left hand

**OEM # D2OZ-24141-65A each . . 41.95**

**Blue**

(Stock # B24-44010-210) - right hand

**OEM # D2OZ-24140-65B each . . 41.95**

(Stock # B24-44015-155) - left hand

**OEM # D2OZ-24141-65B each . . 41.95**

**Ginger**

(Stock # B24-44000-010) - right hand

**OEM # D2OZ-24100-62A each . . 41.95**

(Stock # B24-44005-010) - left hand

**OEM # D2OZ-24101-62A each . . 41.95**

**White**

(Stock # B24-44000-015) - right hand

**OEM # D2OZ-24100-65E each . . 41.95**

(Stock # B24-44005-015) - left hand

**OEM # D2OZ-24101-65E each . . 41.95**

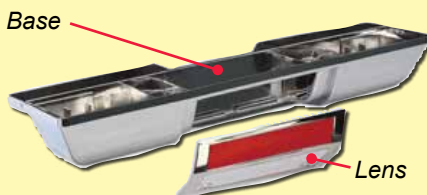

## Arm Rest Base

An exact reproduction armrest base manufactured to replicate the original vacuum metallized chrome armrest base.

This is the base only, you must re-use your original light assembly and wiring. Lens and armrest pads are sold separately. Requires 2 per car.

1966 Fairlane - XL and GT

(Stock # B24-44006-100)

**OEM # C6OZ-24144-63A each . . . . . 0.00**



## Arm Rest Mounting Clip

1965 Fairlane - front door

1970 Fairlane - front door

1970 Comet - door without molded armrest

1970-71 Torino - front door

1970-71 Montego and Ranchero

1972 Torino and Ranchero

(Stock # P24-44025-100)

**OEM # C5AZ-24146-62B each . . . 8.95**



## Arm Rest Clip

1966-69 Fairlane - front doors, rear doors and rear quarter

1967-70 Montego

(Stock # P24-44025-005)

**OEM # C7AZ-24146-62A each . . . 0.95**

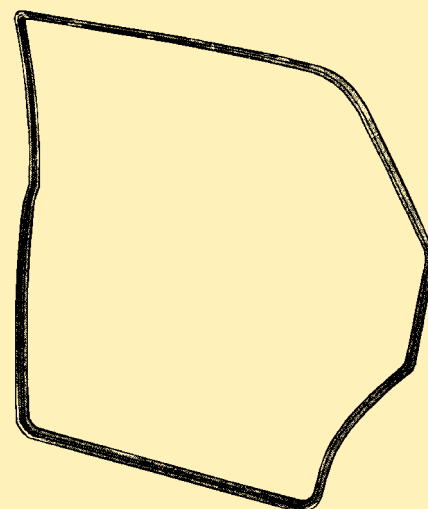

## Rear Door Seal Set

Molded to fit - Does both doors.

1966-67 Fairlane - 4 door Sedan

(Stock # B25-45000-042)

**OEM # C6OZ-25324-54A set . . . 144.95**

1966-67 Fairlane - 4 door Station Wagon

(Stock # B25-45000-043)

**OEM # C6OZ-25324-71A set . . . 119.95**

**When you need your parts yesterday, we understand! We offer several different options for Air Delivery. Inquire when placing your order.**

# 1962-72 Fairlane

FAIRLANE 500

## Fairlane 500 Rear Quarter Panel Emblem

This part has been meticulously reproduced to the original specifications. This very hard to find emblem is made like the original with triple chrome plating and factory black paint recess. We have now reproduced the original rear quarter panel emblems used on 1965 and 1966 Fairlane base model and "500XL". A quality reproduction made in the USA!

1965-66 Fairlane 500  
(Stock # B25-45030-105) **Price Reduced!**  
**OEM # C50Z-25622-62A each . . . 125.95**

FAIRLANE

## Fairlane Rear Quarter Panel Emblem

This part has been meticulously reproduced to the original specifications. This very hard to find emblem is made like the original with triple chrome plating and factory black paint recess.

1965-66 Fairlane  
(Stock # B25-45030-106) **Price Reduced!**  
**OEM # C50Z-25622-62B each. . 124.95**

*Cyclone*

## Cyclone Rear Quarter Panel Script

Chrome plated with black recesses.  
1968-71 Cyclone  
(Stock # M25-45030-115) **Price Reduced!**  
**OEM # C8GY-25622-63A each. . . . 0.00**



Classic Auto Parts has been serving your car and truck needs since 1974!  
We appreciate our customers!

*Fairlane*

## Fairlane Rear Quarter Panel Script

New reproduction "Fairlane" Script used on the 1968/1970 Fairlane 500 **Price Reduced!**  
(Stock # B25-45030-120)  
**OEM # C80Z-25622-54A each . . 98.95**

TORINO

## Torino Rear Quarter Panel Script

Exact reproduction of original quarter panel script used on 1968/1970 Torino. Chrome plated with correct black paint  
1968-70 Torino  
1968-69 Torino - Station Wagon on tailgate  
(Stock # B25-45030-125)  
**OEM # C80Z-25622-63A each . . 35.95**

*Squire*

## Squire Rear Quarter Panel Script

Plated and painted as original.  
1968-71 Fairlane - Station Wagon  
1970-72 Ranchero  
(Stock # B25-45030-130)  
**OEM # C80Z-25622-71A each . 104.95**

TORINO

## Torino Rear Quarter Panel Script

Chrome plated with black paint.  
1971 Torino  
(Stock # B25-45030-155)  
**OEM # D10Z-25622-65B each . . 53.95**

**1-800-654-3247**  
**Call Us for**  
**All-American**  
*Deals*



## Rear Quarter Trim Upholstery

Also called rear armrest covers. Stitched 32 oz. vinyl in colors to match your interior. Uses original grain vinyls.  
1968-69 Torino - GT Convertible  
(Stock # B27-47010-025) - **aqua**  
**OEM # C80Z-27540/1-76A pair . . . 97.95**  
(Stock # B27-47010-030) - **black**  
**OEM # C80Z-27540/1-76BLK pair . 97.95**  
(Stock # B27-47010-035) - **blue**  
**OEM # C80Z-27540/1-76BLU pair . 97.95**  
(Stock # B27-47010-040) - **ivy green**  
**OEM # C80Z-27540/1-76IG pair. . . 97.95**  
(Stock # B27-47010-045) - **nugget gold**  
**OEM # C80Z-27540/1-76NG pair . . 97.95**  
(Stock # B27-47010-050) - **red**  
**OEM # C80Z-27540/1-76RD pair . . 97.95**  
(Stock # B27-47010-055) - **white**  
**OEM # C80Z-27540/1-76WH pair . 97.95**



1970-71 Torino - Convertible  
**Black, red, blue, white, ginger and ivy green**  
(Stock # B27-47010-060)  
**OEM # D00Z-27540/1-76SPO set. . 83.95**

Please allow 7-14 days for Special Orders!

**Don't forget to join our e-mail list. We send out e-mail specials, and don't want you to miss out!**

Rear Quarter Parts

# 1962-72 Fairlane

Rear Quarter Parts

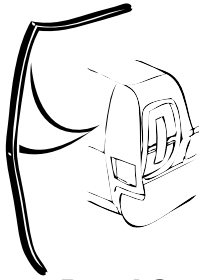

### Rear Quarter Panel Seals

Seals the rear quarter panel to the rear quarter of the car.

1968 Fairlane

(Stock # B27-47025)

**OEM # C8OZ-27802-54A pair . . . 12.95**



### Lower Front of Rear Quarter Patch Panel

Die stamped steel. Lower front of rear section - **17" high x 37" long**

1968-69 Fairlane and Torino - 2 door models

(Stock # B27-47065-288) - **right hand**

**OEM # C8OZ-27840-70LFR each . . 173.95**

(Stock # B27-47070-302) - **left hand**

**OEM # C8OZ-27841-70LFL each . . 173.95**



### Lower Rear of Rear Quarter Patch Panel

Die stamped steel. Lower rear of rear section - **17" high x 54" long**

1968-69 Fairlane and Torino - 2 and 4 door models

(Stock # B27-47065-289) - **right hand**

**OEM # C8OZ-27840-70LRR each . . 306.95**

(Stock # B27-47070-288) - **left hand**

**OEM # C8OZ-27841-70LRL each . . 306.95**

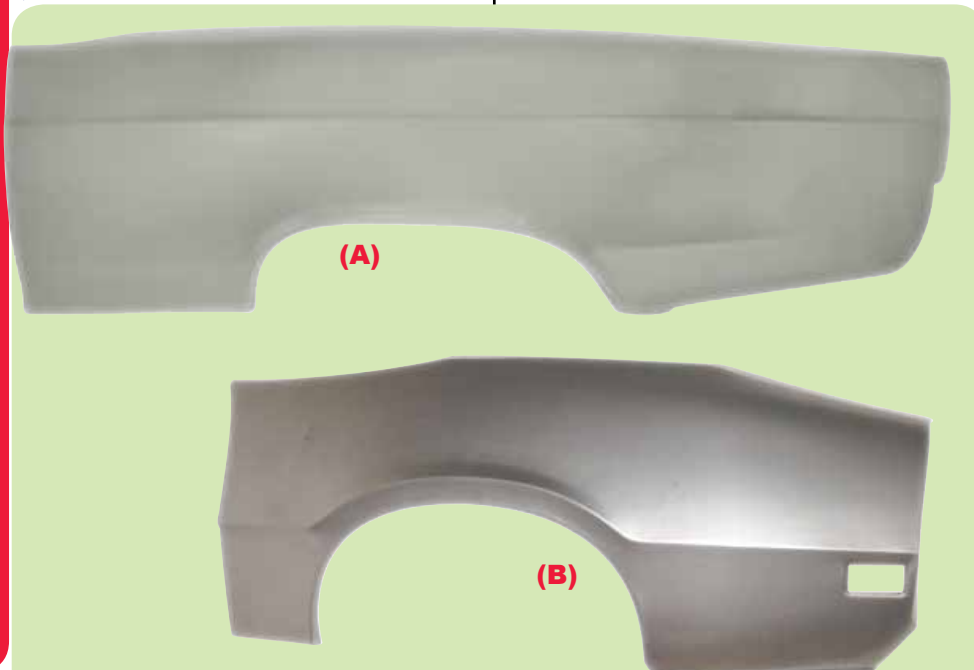

### Rear Quarter Panel Skins

These are just the outer die stamped steel piece that can be used as a patch panel outer "Skin" to rework your damaged, dented or rusted rear 1/4.

NOTE: Motor freight shipping

1966-67 Fairlane - 2 door Models

(Stock # B27-47065-196) - **right hand**

**OEM # C6OZ-27840-80R each . . . . . 595.00**

(Stock # B27-47070-199) - **left hand**

**OEM # C6OZ-27841-80L each . . . . . 595.00**

1970-77 Comet - 2 door Models

(Stock # B27-47065-324) - **right hand**

**OEM # D1MY-27840-70R each . . . . . 254.95**

(Stock # X27-47070-345) - **left hand**

**OEM # D1MY-27841-70L each . . . . . 254.95**

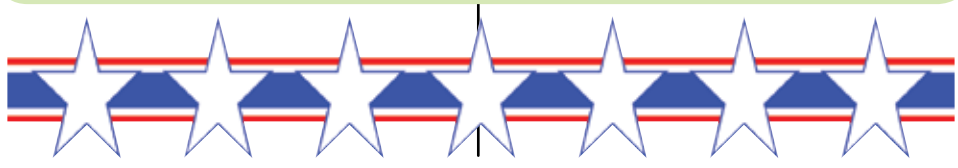

### Rear Quarter Panel Hash Mark

These are the straight hash emblems that mount on the quarter panel next to the GT lettering. All new tooling for a perfect fit and finish. Requires 10 per car.

1970 Torino - Fastback, Ranchero and Convertible

(Stock # B28-48010-005)

**Price Reduced!**

**OEM # D0OZ-28032-65A each . . 37.95**



### Quarter Extension Seals

Located between the rear quarter extension and rear bumper.

1968-69 Torino

(Stock # B28-48022-100)

**OEM # C8OZ-280A94-54A pair . . 14.95**

Check out our Swap Meet Schedule to see when we will be in your area. Maybe even save some on shipping. Call one of the guys for more information!



# 1962-72 Fairlane

Rear Quarter Parts



### Universal Moldings Clips

These are a snap off style with 10-24 x 3/4" bolt to fit up to 2 1/2" wide molding.

(Stock # Z29-49000-030) - set of 10

OEM # U-29000-CLAK set . . . . . 9.95



### Coat Hanger

With set screw

1962-65 Fairlane - except Convertible and Ranchero

1966 Fairlane Convertible

1967 Fairlane - All

(Stock # P29-49025)

OEM # B2A-29025-70A each . . . . 6.95



### Coat Hanger

Complete with set screw

1964-66 Fairlane - except Convertible

(Stock # P29-49025-005)

OEM # C4AZ-29025-62A each. . . . 6.95



### Coat Hook

Black plastic - without base

1968-72 Fairlane/Torino

1968 70 Comet

(Stock # P29-49020-222)

OEM # C8AZ-29024-62A each. . . . 4.95



### Coat Hanger Retainer

The plastic retainer for the coat hook.

1968-72 Fairlane and Torino

(Stock # P29-49180)

OEM # C8AZ-29232-62A each. . . . 3.95

**Obsolete & ClassicAutoParts, Inc.**

Bed Rail Molding



### Bed Rail Moldings

Commonly referred to as "Hockey sticks"

These are the long molding that runs the length of your bed. Fits all models of Ranchero for 1972-79. A very hard to find item that is a must for any Ranchero.

1972-79 Ranchero

(Stock # B29-49060-100) - right hand

OEM # D2OZ-29038-97A each . . . 179.95

(Stock # B29-49065-010) - left hand

OEM # D2OZ-29039-97A each . . . 179.95

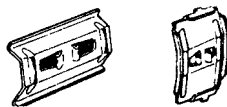

### Body Side Molding Clip

1962 Fairlane - front door, rear door, quarter and front fender

(Stock # B29-49100-010)

OEM # C2OZ-29120-62A each . . . 2.95

1964 Fairlane - quarter panel molding

(Stock # B29-49100-025)

OEM # C4OZ-29120-62B each. . . . 2.95



### Rear Quarter Panel Emblem

This is an American made replica of the original chrome plated rear quarter panel emblem used on all 1966 Fairlane 500XL models. An American made, chrome plated reproduction.

1966 Fairlane 500 XL

(Stock # B29-49105-075)

OEM # C6OZ-291B30-63A each . . 143.95

**Friend us on Facebook and follow us on Twitter. You never know what you might be in for.**



### Rear Quarter Panel Emblem

Cast in the original design, triple chrome plated and painted in the correct paint scheme. These are made in the USA!

1967 Fairlane 500

(Stock # B29-49105-034) - right hand

OEM # C7OZ-291B30-62A each . . 116.95

(Stock # B29-49110-045) - left hand

OEM # C7OZ-291B31-62A each . . 116.95



### Rear Quarter Panel Emblem

New chrome plated emblem.

1968-69 Ranchero

1968-70 Fairlane and Torino

1972 Ranchero

(Stock # B29-49105-069)

OEM # C8OZ-291B30-54A each . . . 53.95



### Molding Clip

Front fender molding and rear quarter molding

1962-63 Fairlane

(Stock # S29-49140-020)

OEM # C1SZ-29144-63A each . . . . 2.95



### Fairlane XL Rear Quarter Panel Emblem

Cast as original, triple chrome plated, painted in the correct scheme and made in the U.S.A.!

1967 Fairlane XL

(Stock # B29-49165-00) - right hand

OEM # C7OZ-29210-63A each . . 64.95

(Stock # B29-49170-010) - left hand

OEM # C7OZ-29211-63A each . 141.95



# 1962-72 Fairlane

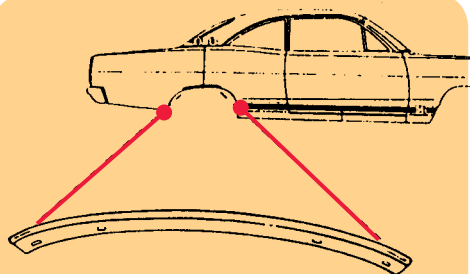

## Rear Wheel Molding

1966 Fairlane  
(Stock # B29-49145-005) - right hand  
**OEM # C6OZ-29164-62A each . . . 39.95**  
(Stock # B29-49150-005) - left hand  
**OEM # C6OZ-29165-62A each . . . 39.95**

1967 Fairlane  
(Stock # B29-49145-020) - right hand  
**OEM # C7OZ-29164-62A each . . . 39.95**  
(Stock # B29-49150-020) - left hand  
**OEM # C7OZ-29165-62A each . . . 39.95**

1968-69 Fairlane and Torino  
(Stock # B29-49145-030) - right hand  
**OEM # C9OZ-29164-54B each. . . 39.95**  
(Stock # B29-49150-030) - left hand  
**OEM # C9OZ-29165-54B each. . . 39.95**

1970-71 Fairlane and Torino - except GT  
(Stock # B29-49145-040) - right hand  
**OEM # D0OZ-29164-65A each . . . 39.95**  
(Stock # B29-49150-040) - left hand  
**OEM # D0OZ-29165-65A each . . . 39.95**

1970-71 Fairlane and Torino - GT  
(Stock # B29-49145-045) - right hand  
**OEM # D0OZ-29164-65B each . . . 39.95**  
(Stock # B29-49150-045) - left hand  
**OEM # D0OZ-29165-65B each . . . 39.95**

## FAIRLANE

### Fairlane Rear Quarter Panel Letters

Reproduction of originals. Pressure die cast and triple chrome plated. Includes mounting clips. One set does one side.  
1966-67 Fairlane - 2 door Hardtop and Convertible - except XL  
(Stock # B29-49165)  
**OEM # C6OZ-29210-63S set . . . . 29.95**

**Save on shipping by watching for our Free Freight e-mails. You can join our e-mail club at [www.ClassicAutoParts.com](http://www.ClassicAutoParts.com)**



### Lower Quarter Window Seals

Lower front on quarter window seals.  
1963-65 Fairlane - Hardtop  
1963 Meteor - 2 door Hardtop  
(Stock # B29-49290-020) **Price Reduced!**  
**OEM # C3OZ-29748/9-65B pair . . . 25.95**

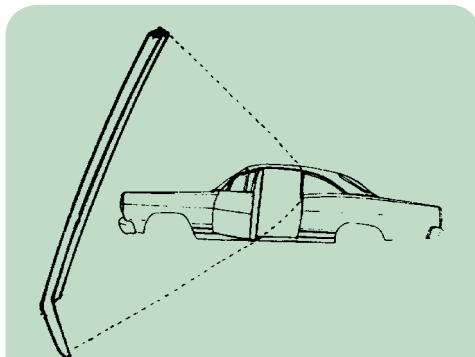

### Quarter Window Vertical Seals

Rear quarter window vertical seals for the front edge of the rear quarter window. Does both windows.  
1963-65 Fairlane - 2 door Hardtop  
1963 Meteor - 2 door Hardtop  
(Stock # B30-50020-075)  
**OEM # C3OZ-30146/7-65C pair . . . 35.95**

1966-67 Fairlane - Hardtop and Convertible  
1966-67 Comet - Hardtop and Convertible  
(Stock # B30-50020-090)  
**OEM # C6OZ-30146/7-63A pair . . . 19.95**

1970-71 Torino - Fastback  
1970-71 Montego - Fastback  
(Stock # B30-50020-095)  
**OEM # D0OZ-30146/7-63A pair . . . 39.95**

1970-71 Fairlane and Torino - Hardtop  
(Stock # B30-50205-100)  
**OEM # D0OZ-30146/7-65A pair . . . 52.95**

# SERVICE

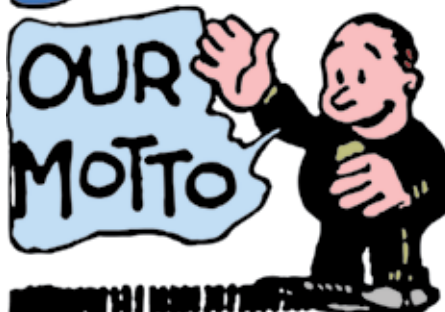

### 1/4 Window Regulator Handle

Chrome Plated with white knob  
1962 Fairlane  
(Stock # X30-50050-001)  
**OEM # C0DZ-30322-64A each. . . 35.95**

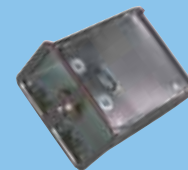

### 1/4 Panel Ash Tray

1966-71 Fairlane - Convertible  
1968-71 Torino  
1965-69 Comet and Montego - Convertible rear seats  
(Stock # P30-50075-005)  
**OEM # C5AZ-30702-76A each. . . 24.95**



### Ash Tray Bumpers

1962-72 Fairlane and Torino  
(Stock # BC3-76480-010)  
**OEM # C2OZ-359422-S each. . . . . 2.95**



### Convertible Quarter Interior Panels

Now available are replacement rear quarter trim panels for 1966/1971 Torino and Fairlane convertible. Manufactured of durable ABS plastic. Designed to replace your cracked, cut or warped originals. Quarter trim vinyl covering sold separately. (Pg. 181)  
1966-67 Fairlane  
1970 Fairlane  
1970-71 Torino  
(Stock # B30-50107-050) **Price Reduced!**  
**OEM # C6OZ-31148/9-76 pair . . . . . 0.00**



Rear Quarter Parts

# 1962-72 Fairlane

Back of Car Parts

## FORD

### 'F-O-R-D'® Hood Letters

1964 Fairlane  
(Stock # B40-52035-025)  
**OEM # C4OZ-40282-62AD set . . . 13.95**

## COMET

### C-O-M-E-T Hood Letters

Rear deck letter set.  
1966 Comet  
(Stock # X40-52035-045)  
**OEM # C6GY-40282-62A set . . . 143.95**

## FORD

### F-O-R-D® Rear Panel Letters

Pressure die cast and chrome plated.  
1968-69 Torino Fastback  
(Stock # B40-52035-050)  
**OEM # C8OZ-40282-63AD set . . 143.95**



### Trunk Emblem

Exact reproduction of the original rear panel embossment used on 1969 Torino Cobra. Adhesive backed metal plate. Made in the U.S.A.!

1969 Fairlane - Cobra  
(Stock # B40-52055)  
**OEM # C9OZ-40316-63A each . . 49.95**



### Rear Body Emblem

1969 Torino - GT  
(Stock # B40-52055-005)  
**OEM # C9OZ-40316-63B each . . . 49.95**



### Fiberglass Rear Valance Panel

Made to replace the steel valance panel. Hand laid fiberglass.  
1970-71 Torino - except Station Wagon and Ranchero  
(Stock # B40-52165)  
**OEM # D1OZ-40544-65A each . . . . . 209.95**  
1972 Torino - all  
(Stock # B40-52165-005)  
**OEM # D3OZ-40544-65A each . . . . . 209.95**



Price Reduced!

Please allow 7-14 days for Special Orders!



### Cobra Grill Snake Emblem

This is a reproduction of the snake accessory used on the Torino. Adhesive backed. Must add pins to mount to grill.  
1971 Torino  
(Stock # B40-52055-105)  
**OEM # D1OZ-40316-63A each . . . . 39.95**



### Coiled Snake Emblem

For the lower back panel and luggage compartment door.  
1969 Fairlane  
(Stock # B40-52090)  
**OEM # C9OZ-403A72-63B each . . . 39.95**



Price Reduced!

### Rear Compartment Panels

This is the HTE package board that mounts vertically to the panel behind the seat. Complete with correct vinyl flap and spare tire flap stitched onto the board as original. Die cut to fit like your originals. Tire flaps on these are colored. Panels need to be dyed to match.

1968-71 Ranchero  
(Stock # B40-52095-005) - **black**  
**OEM # C8OZ-40374-66E each . . . 89.95**  
(Stock # B40-52095-010) - **white**  
**OEM # D0OZ-40374-66A each . . 71.95**  
(Stock # B40-52095-015) - **ginger**  
**OEM # D0OZ-40374-66B each . . 71.95**  
(Stock # B40-52095-020) - **blue**  
**OEM # D0OZ-40374-66D each . . 71.95**  
1972 Ranchero - **black**  
(Stock # B40-52095-025) - **black**  
**OEM # D2OZ-40374-66E each . . 71.95**



### Fuel Lid Emblem

Beautiful exact reproduction of the plastic insert used in the rear fuel filler lid. Made in the U.S.A.!

1962 Fairlane - 2 and 4 door Sedan  
1963 Fairlane - except Station Wagon  
(Stock # B40-52205-225)  
**OEM # C2OZ-405A86-62B1 each . . 104.95**



# 1962-72 Fairlane



## Belt Molding Clip

1963 Fairlane  
(Stock # B40-52225-035)  
**OEM # C3OZ-407A12-59A each . . 2.95**

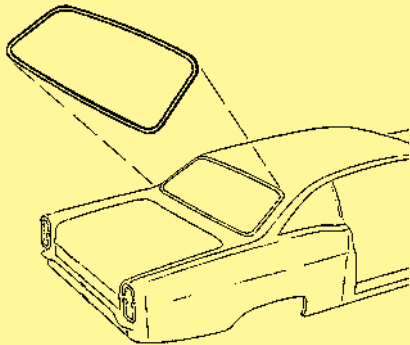

## Rear Window Rubber

1962-63 Fairlane - 500 and Custom 300 four door Sedan  
(Stock # P42-54085-250)  
**OEM # C1AB-42084-64C each. . . . 119.95**  
1962-63 Fairlane - 2 and 4 door Sedan  
(Stock # B42-54085-290)  
**OEM # C2OZ-42084-62A each . . . 107.95**  
1963-65 Fairlane - 2 door Hardtop  
1963 Meteor - Hardtop  
(Stock # B42-54085-310)  
**OEM # C3OZ-42084-65A each . . . . 71.95**  
1964-65 Fairlane - 2 and 4 door Sedan  
(Stock # B42-54085-320)  
**OEM # C4OZ-42084-62A each . . . 107.95**  
1966-67 Ranchero  
(Stock # X42-54085-335)  
**OEM # C6DZ-42084-66A each. . . . 79.95**  
1966-67 Fairlane - 4 door Sedan  
1966-67 Comet - 4 door Sedan  
(Stock # B42-54085-340)  
**OEM # C6OZ-42084-54A each . . . . 54.95**  
1966-67 Fairlane - 2 door Sedan  
1966-67 Comet - 2 door Sedan  
(Stock # B42-54085-345)  
**OEM # C6OZ-42084-62A each . . . . 54.95**  
1966-67 Fairlane - 2 door Hardtop  
1966-67 Comet - 2 door Hardtop  
(Stock # B42-54085-350)  
**OEM # C6OZ-42084-63A each . . . . 77.95**

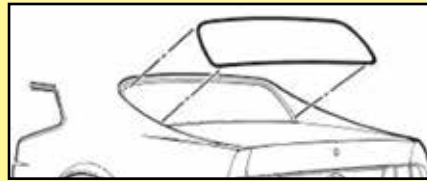

## Rear Window Rubber

1968-69 Fairlane - 2 and 4 door Sedan  
1968-69 Torino - 2 door Hardtop  
1968-69 Montego - 4 door Sedan  
(Stock # B42-54085-400)  
**OEM # C8OZ-42084-54A each . . . . 89.95**  
1968-69 Fairlane - 2 door Hardtop Notch-back  
1968-69 Montego - 2 door Hardtop  
(Stock # B42-54085-405)  
**OEM # C8OZ-42084-65A each . . . . 69.95**  
1968-71 Ranchero  
(Stock # B42-54085-415)  
**OEM # C8OZ-42084-66A each . . . . 71.95**  
1970-71 Torino - 2 door Sedan and Hardtop  
(Stock # B42-54085-425)  
**OEM # D0OZ-42084-65A each . . . . 84.95**  
1972-73 Torino - Fastback  
(Stock # B42-54085-430)  
**OEM # D2OZ-42084-63D each . . . . 84.95**  
1972-76 Torino - Gran Torino and Hardtop  
(Stock # B42-54085-435)  
**OEM # D2OZ-42084-65D each . . . . 84.95**  
1972-79 Ranchero  
(Stock # B42-54085-440)  
**OEM # D2OZ-42084-97A each . . . . 78.95**



## 'GT' Crown Decal

This is the small insert that is located in the crown of the trunk emblems. An exact reproduction with factory colors. Replace that old faded emblem today!  
1966 Fairlane  
(Stock # B42-54280-005)  
**OEM # C6OZ-42502-GT each . . . . 5.95**



## 'XL' Crown Decal

This is the small insert that is located in the crown of the trunk emblems. An exact reproduction with factory colors. Replace that old faded emblem today!  
1966 Fairlane  
(Stock # B42-54280-010)  
**OEM # C6OZ-42502-XL each . . . . 6.95**



## '500' Crown Decal

This is the small insert that is located in the crown of the trunk emblems. An exact reproduction with factory colors. Replace that old faded emblem today!  
1966-67 Fairlane 500  
(Stock # B42-54280)  
**OEM # C6OZ-42502-500 each. . . . 2.95**



## 'XL' Trunk Crown Emblem

Die cast chrome plated with original colored insert.  
1966 Fairlane XL  
(Stock # B42-54280-015)  
**OEM # C6OZ-425A02-63D each . . 179.95**



## Fairlane GTA Trunk Crown Emblem

Chrome plated. Complete with colored insert as original.  
1966 Fairlane - GTA  
(Stock # B42-54280-025)  
**OEM # C6OZ-425A02-63F each. . . 179.95**



## Fairlane GT Trunk Crown Emblem

Chrome plated. Complete with colored insert as original.  
1966 Fairlane GT  
(Stock # B42-54280-020)  
**OEM # C6OZ-425A02-63E each . . . . 0.00**



## Fairlane 500 Trunk Crown Emblem

Chrome plated with colored insert as original  
1966 Fairlane 500  
(Stock # B42-54310-045)  
**OEM # C6OZ-42528-62A each . . . . 4.95**

Price Reduced!

**Online order is available 24/7!**  
**www.ClassicAutoParts.com**

Back of Car Parts

IF YOU HAVE ANY QUESTIONS, JUST GIVE US A RING!



# 1962-72 Fairlane

Back of Car Parts

## Sports Coupe

### Sports Coupe Emblem

Chrome plated  
1962-63 Fairlane



1965 Fairlane Sports Coupe  
(Stock # B42-54310-037)

**OEM # C2OZ-42528-62A each . . 59.95**



### Fairlane GTA Trunk Emblem Decal

This is the small insert that is located in the crown of the trunk emblems. An exact reproduction with factory colors. Replace that old faded emblem today!

1967 Fairlane GTA  
(Stock # B42-54310-065)

**OEM # C7OZ-42528-GTA each . . 17.95**



### Fairlane XL Trunk Crown Decal

This is the small insert that is located in the crown of the trunk emblems. An exact reproduction with factory colors. Replace that old faded emblem today!

1967 Fairlane XL  
(Stock # B42-54310-070)

**OEM # C7OZ-42528-XL each . . . 25.00**

## Fairlane 500

### Fairlane 500 Trunk Crown Emblem

Die cast chrome plated  
1967 Fairlane 500  
(Stock # B42-54310-050)

**OEM # C7OZ-42528-63A each . . . 349.95**

## Fairlane GT

### Fairlane GT Trunk Crown Emblem

Chrome plated with colored insert as original

1967 Fairlane GT  
(Stock # B42-54310-055)

**OEM # C7OZ-42528-63B each . . . . . 0.00**

## Fairlane XL

### Fairlane XL Trunk Crown Emblem

Chrome plated with original colored insert.  
1967 Fairlane XL

(Stock # B42-54310-060)

**OEM # C7OZ-42528-63C each . . . 199.95**

## Ranchero

### Ranchero Quarter Panel Script

Correct stud mounting and painted red as original.

1968-69 Ranchero - GT and 500 **Price Reduced!**  
(Stock # B42-54310-075)

**OEM # C8OZ-42528-66A each . . 24.95**

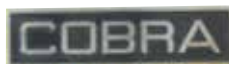

### Cobra Ornament

This is the cobra name plate without the snake.

1969 Fairlane - Cobra  
(Stock # B42-54310-080)

**OEM # C9OZ-42528-65A each . . . 15.95**

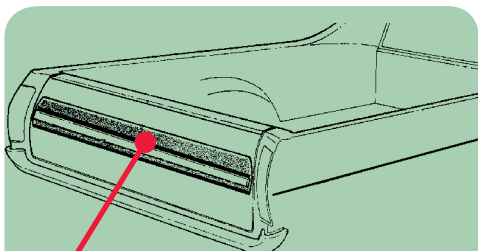

### Tailgate Stripe Kit

All kits are precision cut using premium quality vinyl in original color match. Stripe kits are under warranty against material defects for six years. Professional installation is recommended. Please allow minimum of two week after new paint job before applying kits.

1972-76 Ranchero

(Stock # B42-54340) - **blue**

**OEM # D2OZ-42602-97A set . . 125.95**

(Stock # B42-54340-005) - **yellow**

**OEM # D2OZ-42602-97B set . . 125.95**

(Stock # B42-54340-010) - **orange**

**OEM # D2OZ-42602-97C set . . 125.95**

(Stock # B42-54340-015) - **silver**

**OEM # D2OZ-42602-97D set . . 125.95**



### Trunk Emblem Insert

1969 Torino GT  
(Stock # B42-54280-030)

**OEM # C9OZ-425A02-65B each . 71.95**

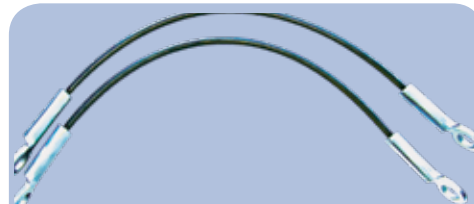

### Ranchero Tailgate Cables

Excellent reproduction steel tailgate cables for your Ranchero are made to original specifications.

1966-71 Ranchero  
(Stock # B43-55070-100)

**Price Reduced!**

**OEM # C6AZ-43052-71A pair . . . 83.95**



### Trunk Lid Latch Assembly

No cylinder or keys.

1962-65 Fairlane - without power release - except Station Wagon  
(Stock # B43-55180-005)

**OEM # C2OZ-43200-62B each . . . 39.95**

1966-70 Fairlane  
(Stock # P43-55180-010)

**OEM # C5AZ-43200-62A each . . . 39.95**



### Trunk Lock Striker

1964-65 Fairlane - body # 54, 62 and 65  
(Stock # B43-55197-005)

**OEM # C4OZ-43252-62A each . . 16.95**



# 1962-72 Fairlane



## Rear Window Chrome Molding Clip

1968-72 Fairlane and Torino **Price Reduced!**  
(Stock # P43-55220)  
**OEM # C5ZZ-43413-65B each . . . . .50**



## Tailgate Bull Emblem

This is an excellent reproduction of the steer emblem used on roof pillars and tailgate of 66/67 Ranchero. Triple plated and painted as original. 3 required per car  
1966-67 Ranchero **Price Reduced!**  
(Stock # B43-55235-060)  
**OEM # C6OZ-43500-66A each . . 97.95**



## Deck Lid Lock and Keys

Includes 2 correct style round Ford® keys.  
1963-66 Fairlane Station Wagon - tailgate  
(Stock # P43-55250-005)  
**OEM # B9A-43505-64A each . . . 23.95**  
1965 Fairlane - trunk lid  
(Stock # B43-55250-020)  
**OEM # C5OZ-43505-62B each. . . 23.95**  
1967-68 Fairlane - trunk lid **Price Reduced!**  
(Stock # P43-55250-025)  
**OEM # C7AZ-43505-62A each. . . 16.95**  
1972 Torino - truck lid  
(Stock # P43-55250-050)  
**OEM # D2AZ-43505-65A each . . 22.95**



## Trunk and Grill Insert

1972 Torino and Ranchero  
(Stock # B40-52055-145)  
**OEM # D2OZ-43514-65A each . . 82.95**

**Call Us:**  
**1-800-654-3247**

## Key Blank



For the glove box, luggage compartment and trunk lid.

1965-72 Fairlane and Torino  
1966-70 Comet and Montego  
(Stock # P43-55300)  
**OEM # C5AZ-43562-62A each. . . 3.95**



## Deck Lid Lock Cylinder Pad

1962-63 Fairlane - Station Wagon  
1965 Fairlane - except Station Wagon  
(Stock # B43-55320-020) **(A)**  
**OEM # C2OB-43625-62A each . . . 3.95**  
1964 Fairlane **(B)**  
(Stock # B43-55320-030)  
**OEM # C4OZ-43625-62A each . . . 1.95**  
1966-67 Fairlane - except Ranchero and Station Wagon  
1968-70 Comet, Montego and Cyclone - except Station Wagon  
(Stock # P43-55320-040) **(C)**  
**OEM # C7AZ-43625-62A each. . . . .95**



## Trunk Door Inside Bumpers

1962-65 Fairlane  
1962-63 Meteor - except Station Wagon  
(Stock # B43-55325)  
**OEM # C2OZ-43634-62A pair . . . . 2.95**



## Door or Trunk Poppers

These spring loaded stainless poppers can be used on doors or trunk. Priced per pair  
**PR 001 . . . . . 41.95**

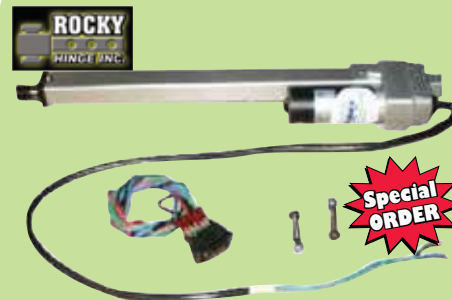

## Hood or Trunk Lift

This motorized unit extends 8" to 12" and will lift up to 250 lbs. Works well on trunks, hoods, or tilt front ends.

**HTL 001 . . . . . 271.95**



## Power Trunk Kit

Our power trunk kit comes complete with solenoids and mounting hardware.

**RTL 006 . . . . . 29.95**



## Trunk Lid Seal Kit

1962-64 Fairlane  
(Stock # P43-55335-045) **(A)**  
**OEM # C3AZ-43720-62A each. . . 14.95**  
1965-72 Fairlane and Torino  
1965-70 Comet and Montego  
(Stock # P43-55335-050)  
**OEM # D0AZ-43720-62A each . . 24.95**



## Tailgate Bumpers

Allows your tailgate to close firmly against the body.

1966-72 Ranchero  
(Stock # X43-55405-004)  
**OEM # C6DZ-439A00-66A each . . 9.95**

Back of Car Parts

# 1962-72 Fairlane

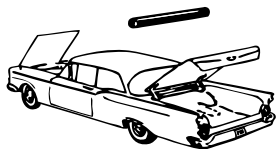

## Trunk Torsion Bar Anti-Rattler

1962-67 Fairlane  
 1963-65 Fairlane - 4 door Station Wagon  
 (Stock # P45-57010)  
**OEM # C0AB-45028-62 each . . . . 3.95**

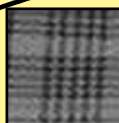
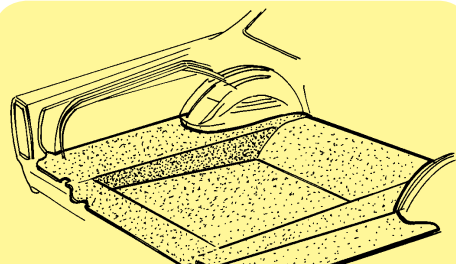

Basketweave Spatter Plaid

## Trunk Mats

1962 Fairlane - **Black/Grey Basketweave**  
 (Stock # B45-57065-035)  
**OEM # C2OZ-45456-62 each . . . . 89.95**

1963 Fairlane - **Plaid Vinyl**  
 (Stock # B45-57065-044)  
**OEM # C3OZ-45456-62 each . . . . 58.95**

1964 Fairlane - **Black/Grey Fleece**  
 (Stock # B45-57065-063)  
**OEM # C4OZ-45456-62 each . . . . 79.95**

1965 Fairlane - **Black/Grey Basketweave**  
 (Stock # B45-57065-075)  
**OEM # C5OZ-45456-62 each . . . . 62.95**

1966 Fairlane - **Black/Grey Basketweave**  
 (Stock # B45-57065-085)  
**OEM # C6OZ-45456-62 each . . . . 76.95**

1967 Fairlane - **Black/Grey Basketweave**  
 (Stock # B45-57065-090)  
**OEM # C7OZ-45456-62 each . . . . 65.95**

1968-69 Fairlane/Torino - **Beige Ford® Spatter**  
 (Stock # B45-57060-245)  
**OEM # C8OZ-45455-63 each . . . . 79.95**

1970 Fairlane - **Light Gray Spatter**  
 - (Stock # B45-57060-255)  
**OEM # D0OZ-45455-63 each . . . . 63.95**

1970-71 Torino - **Light Gray Spatter**  
 With gas filler cut out  
 (Stock # B45-57060-400)  
**OEM # D0OZ-45455-63B each . . 76.95**

Without gas filler cutout  
 (Stock # B45-57060-425)  
**OEM # D0OZ-45455-63C each . . 79.95**

1972 Torino - **Light Gray Spatter**  
 (Stock # B45-57065-205)  
**OEM # D2OZ-45456-63 each . . . . 45.95**



## Trunk Pocket Cover

This fills the gap between the fender and the trunk floor so your mat/carpet will not fall through. Made of ABS plastic.  
 1966-71 Fairlane and Torino  
 (Stock # B45-57055-300)  
**OEM # C6OZ-45454-62ABS each . . 52.95**



## Tool Bag Kit

Burtex plaid. Fits all cars with Burtex trunk mats.  
 (Stock # P45-57075)  
**OEM # C0AZ-45458-62 each . . . . 17.95**



## Roof Rear Sail Panels

Manufactured of durable ABS plastic which will not crack like the original Ford® pieces. Features original grain texture, correct factory fit and design. Available in black only, can be dyed to match.  
 1970-71 Torino - Fastback  
 (Stock # B46-58127-100)  
**OEM # D0OZ-465A04/5-63A pair . . 71.95**

1970-71 Torino - formal roof  
 (Stock # B46-58127-125)  
**OEM # D0OZ-465A04/5-65A pair . . 79.95**

**Friend us on Facebook and follow us on Twitter. You never know what you might be in for.**

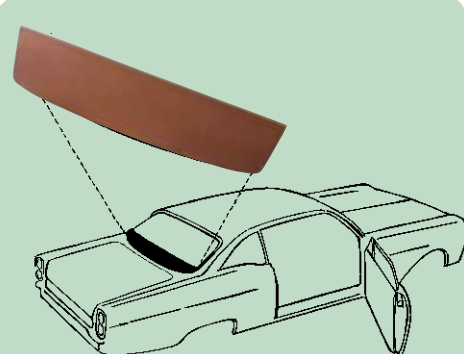

## Package Tray

1963-65 Fairlane - Sport Coupe  
 (Stock # B46-58130-012)  
**OEM # C3OZ-46506-65 each . . . . 28.95**

1966-67 Fairlane  
 (Stock # B46-58130-045)  
**OEM # C6OZ-46506-63 each . . . . 24.95**

1966-67 Comet - GT and Cyclone  
 (Stock # X46-58130-037)  
**OEM # C6GY-46506-63 each . . . . 29.95**

1966-71 Ranchero - with attached sound deadener  
 (Stock # X46-58130-038)  
**OEM # C6GY-46506-66 each . . . . 49.95**

1968-69 Torino Fastback  
 (Stock # B46-58130-064)  
**OEM # C8OZ-46506-63 each . . . . 79.95**

1968-69 Torino Coupe  
 (Stock # B46-58130-069)  
**OEM # C8OZ-46506-65 each . . . . 87.95**

1970-71 Torino Fastback  
 (Stock # B46-58130-072)  
**OEM # D0OZ-46506-63 each . . . . 72.95**

1970-71 Torino Coupe  
 (Stock # B46-58130-078)  
**OEM # D0OZ-46506-65 each . . . . 52.95**

1972-79 Ranchero  
 (Stock # B46-58130-095)  
**OEM # D2OZ-46506-66 each . . . . 22.95**

1972 Torino - Fastback - with speaker holes  
 (Stock # B46-58155-025)  
**OEM # D2GY-46668-63 each . . . . 47.95**

1972 Torino Coupe  
 (Stock # B46-58155-035)  
**OEM # D2GY-46668-65 each . . . . 23.95**

## Rear Package Tray Insulation

This is a pre-cut pad that goes under your package tray.  
 1964-68 Fairlane/Torino  
 (Stock # B46-58130-056)  
**OEM # C6OZ-46506-63I each . . . . 19.95**

1968-73 Torino  
 (Stock # B46-58130-062)  
**OEM # C8OZ-46506-65I each . . . . 19.95**

# 1962-72 Fairlane

## Sports Coupe

### Sports Coupe Roof Side Emblem

Chrome plated. Located on the rear pillar. Includes clips for installation.

1964-65 Fairlane

1966-67 Comet - 2 door - for glove box  
(Stock # B50-61115-010)

**OEM # C4OZ-50399-65A each . . . 0.00**



### Folding Top Bushings

For folding top rear side rail to power cylinder bushings of convertibles

1966-71 Fairlane

1966-69 Comet and Montego

(Stock # P50-61120)

**OEM # C3AZ-50412-76A each. . . . 4.95**



### Convertible Top "J" Hooks

Chrome plated with correct thread size  
1965-66 Fairlane Convertible

(Stock # P50-61145)

**OEM # C5ZZ-50536-76A pair . . . 13.95**

1967-70 Convertible

(Stock # P50-61235)

**OEM # C6AZ-506A48-76A pair . . 13.95**



### Convertible Top Latch Springs

1966-70 Convertible

(Stock # B50-61190-100)

**OEM # C5ZZ-50572-76A pair . . . . 9.95**

**Friend us on  
Facebook and follow  
us on Twitter. You  
never know what you  
might be in for.**



### Convertible Top Hydraulic Cylinders

These are special order. Please specify year of car so we can insure you receive the correct cylinder. Sold in pairs only.

**Special Order - Allow 2 weeks on delivery**

1966-71 Fairlane - Convertible

1966-70 Comet - Convertible

(Stock # P50-61210)

**OEM # B5A-50600/1-76SPO pair . 536.95**

end view



### Roof Rail Seal

We have made this seal to fit many of the Ford® product cars. It is exactly the same, except it does not have molded ends. We recommend that you razor blade your ends off and glue them onto these seals. It is the economical way to go and an alternative for those applications that are not being made. Sold in 8 foot pairs.

(Stock # P51-62005-040) - **narrow style**

**OEM # C0AZ-51222/3-62A pair . . . 39.95**



Classic Auto Parts has been serving your car and truck needs since 1974!

We appreciate our customers!

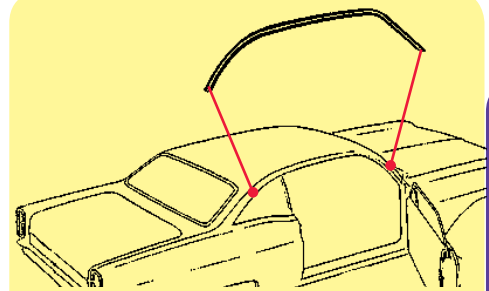

### Roof Side Rail Weatherstrip

1963-65 Fairlane - Hardtop

1963 Meteor - Hardtop

(Stock # B51-62005-085)

**OEM # C3OZ-51222/3-65E pair . . 419.95**

1966-67 Fairlane - 2 door Hardtop

1966-67 Comet - 2 door Hardtop

(Stock # B51-62005-115)

**OEM # C6OZ-51222/3-63B pair . . . 59.95**

1968-69 Fairlane - 2 door Hardtop Fast-back

1968-69 Montego - 2 door Hardtop

(Stock # B51-62005-160)

**OEM # C8OZ-51222/3-63A pair . . . 89.95**

1968-69 Ranchero

(Stock # B51-62005-165)

**OEM # C8OZ-51222/3-66A pair . . 119.95**

1970-71 Torino

1970-71 Comet and Montego

(Stock # B51-62005-210)

**OEM # D0OZ-51222/3-65A pair . . 144.95**

1970-71 Ranchero

(Stock # B51-62005-215)

**OEM # D0OZ-51222/3-66A pair . . 179.95**

1972-76 Gran Torino 2 dr Hardtop Fast-back

(Stock # B51-62005-250)

**OEM # D3OZ-51222/3-63A pair . . 132.95**

1972-76 Torino - 2 door Hardtop Notch-back

(Stock # B51-62005-255)

**OEM # D3OZ-51222/3-65A pair . . 132.95**

1972-76 Ranchero

(Stock # B51-62005-260)

**OEM # D3OZ-51222/3-97A pair . . 155.95**

**I want you to check out our website for easy shopping and current prices for anything you may need. Don't want to order on-line?**



**Just give us a call and we'll be happy to help!**

# 1962-72 Fairlane

**Obsolete & Classic Auto Parts, Inc.**

8701 South I-35  
Oklahoma City, OK 73149

## Summer Store Hours:

Monday - Friday  
8 a.m. thru 6 p.m.  
Saturday  
8 a.m. thru 12 p.m.

## Winter Store Hours:

Monday - Friday  
8 a.m. thru 5 p.m.  
Saturday  
8 a.m. thru 12 p.m.  
(Central Standard Time)

We accept VISA • DISCOVER  
MASTERCARD

check us out at  
[www.classicautoparts.com](http://www.classicautoparts.com)

**NEXT DAY AIR**  
service available  
on ALL orders!



### Convertible Top Rear Bow or Belt Rail Binding Tip

1966-71 Fairlane and Torino  
1966-69 Comet and Montego  
(Stock # P51-62080)  
**OEM # C3AZ-514A00-76B each . . 4.95**



### Convertible Dowel Pins

Helps top alignment as top goes down onto the visor brackets.  
1965-66 Fairlane - Convertible  
1968 Fairlane - Convertible  
(Stock # B51-62090-100)  
**OEM # C5ZZ-514A38-76B pair . . 19.95**

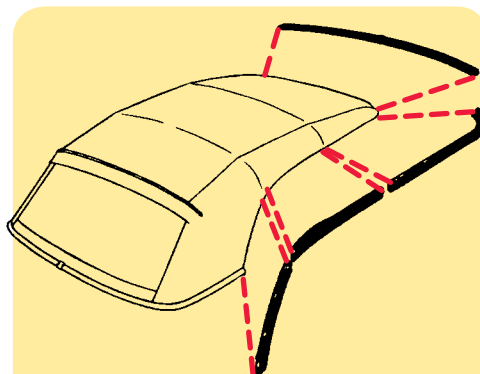

### Convertible Top Weatherstrip Kit

Includes header bow seal.  
1966 Fairlane  
1966-67 Comet  
(Stock # B51-62125-075) - 9 pieces  
**OEM # C6OZ-51562-76K kit . . . 455.95**  
1967 Fairlane  
(Stock # B51-62125-080) - 9 pieces  
**OEM # C7OZ-51562-76K kit . . . 455.95**  
1968-69 Fairlane  
(Stock # B51-62125-085) - 5 pieces  
**OEM # C8OZ-51562-76K kit . . . 489.95**

Check out our Swap Meet Schedule to see when we will be in your area. Maybe even save some on shipping. Call one of the guys for more information!



### Roof Side Plastic Insert

Beautifully reproduced emblem with all the correct colors and lion design inside each colored section.  
1964 Fairlane  
(Stock # B51-62230)  
**OEM # C4OZ-517A18-65A each . . . 29.95**



### Roof Side Ornament Housing

Die cast chrome plated - fits around above emblem. Fits either side.  
1964 Fairlane  
(Stock # B51-62265-010)  
**OEM # C4OZ-517A56-65A each . . . 29.95**



### Roof Pillar Inserts

This new insert embossment is used on the quarter pillar of the formal roof Torino. An exact American made reproduction.  
1968-69 Torino  
(Stock # B51-62235-070)  
**OEM # C8OZ-517A20/1-65A pair . . 71.95**



### Roof Side Emblem

Ranchero steer - chrome plated and painted as original.  
1968-71 Ranchero  
(Stock # B51-62270)  
**OEM # C8OZ-517A57-66A each . . . 75.00**



### Headliner Rod Retainers

1962-65 Fairlane  
(Stock # B42-54120-100)  
**OEM # C0AB-42180-65K pair . . . 4.95**

# 1962-72 Fairlane



Tier Grain      Perforated      Crater Grain

## Headliners

Our headliners are made in the original material, or the closest substitute available. We should be able to supply you with headliners for all body styles 1962-72. Please allow 14-20 weeks for delivery as these are made to your exact specifics. If your headliner is other than black or white, we will need a clean 2" x 2" sample piece. **When ordering, please include the following information:**

1. Year of car
2. Body style
3. How many metal bows are in the roof
4. Color
5. Pattern

Double check all your information before ordering, as all headliners are custom made and non-returnable. All special order items must be paid for in advance.

## Vinyl Headliner

1962-72 All **Special ORDER**  
 1966-72 Comet, Caliente, Cyclone, and Montego  
 (Stock # P51-62290-025)  
**OEM # COAZ-51916-70VYSPO . . . . . 0.00**

## Cloth Headliner

1962-72 All **Special ORDER**  
 (Stock # P51-62290-020)  
**OEM # COAZ-51916-70CLSPO . . . . . 0.00**



## Convertible Top Pads

1966-71 Fairlane and Torino - Convertible  
 1966-71 Comet, Montego and Cyclone - Convertible  
 (Stock # P52-63080-005) **Price Reduced!**  
**OEM # COAZ-52701-76SPO set . . . . . 94.95**

**Please allow 7-14 days for Special Orders!**



## Convertible Tops

All of our kits are made from 38 ounce 'heavy duty' OEM material. They are made in the original material, or the closest substitute available. All tops are made of the correct pin-point vinyl backed material with a heavy duty sateen backing as the originals. They have dielectric ally heat sealed seams and sewn to original factory specifications.

**Please include the following information when ordering:**

1. Part number
2. Year of car
3. Desired color - If you desire a color other than black or white, please send a clean sample so we can insure correct color matching.

Be sure to include all information necessary when purchasing a convertible top or back window, as they are made to your specifications, and are non-returnable.

## Convertible Top Without Window

1966-71 Fairlane and Torino - Convertible **Price Reduced!**  
 1966-71 Comet, Montego and Cyclone - Convertible  
 (Stock # P52-63075-140)  
**OEM # COAZ-52700-SPO each . . . . . 252.95**

## Convertible Top with Glass Back Window

1966-71 Fairlane and Torino - Convertible  
 1966-71 Comet, Montego and Cyclone - Convertible  
 (Stock # P52-63075-125)  
**OEM # COAZ-52700-76GSPO each . . . . . 519.95**

## Convertible Top with Plastic Back Window

1966-71 Fairlane and Torino - Convertible  
 1966-71 Comet, Montego and Cyclone - Convertible  
 (Stock # P52-63075-125)  
**OEM # COAZ-52700-76PSPO each . . . . . 389.95**

## Convertible Top Well Liners

1966-71 Fairlane and Torino - Convertible  
 1966-71 Comet, Montego and Cyclone - Convertible  
 (Stock # P52-63085-020) - black only **Price Reduced!**  
**OEM # COAZ-52702-76SPO each . 149.95**

## Convertible Top Boot

1966-71 Fairlane and Torino  
 1966-71 Comet, Montego and Cyclone  
 Specify Color When Ordering  
 (Stock # P52-63095-017)  
**OEM # COAZ-52704-76SPO each . 239.95**

**Please allow 10-14 days for Special Orders!**

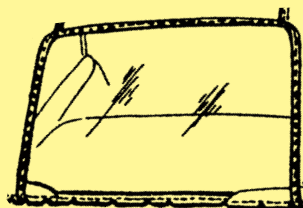

## Convertible Top Replacement Back Windows

These install into your current convertible top. Specify the year of your car as these are specially sized to your application. Also state the color of lining around the window to match your top. Allow 2-4 weeks for delivery. Sold separately.

### Glass Back Window with Zipper

1966-71 Fairlane and Torino  
 1966-71 Comet, Cyclone and Montego  
 (Stock # P52-63090-015)  
**OEM # COAZ-52703-76GSPO . . . . . 199.95**

### Plastic Back Window

1966-71 Fairlane and Torino  
 1966-71 Comet, Cyclone and Montego  
 (Stock # P52-63090-025)  
**OEM # COAZ-52703-76PSPO . . . . . 163.95**

# 1962-72 Fairlane



## Vinyl Roof

You will be impressed with the quality and fit. All double seams are heat sealed to prevent leakage and rust. All patterns are fitted, not universal, and have been used since the vehicle was built. Available in black and white, with additional colors costing more.

Additional colors: buckskin, autumn maple, almond, medium dark royal blue, dark briar brown, dark royal blue, silver metallic, gunmetal metallic, dark sandstone, light sage, light chestnut, garnet red, light sapphire blue, dark garnet, medium sapphire blue, light beechwood, alabaster and bright white available from \$199.95 to \$239.95 each depending on the make of you Fairlane.

Please include the following information when ordering:

1. Year of car
2. Body style
3. Desired color

Be sure to include all information necessary when purchasing, as they are made to your specifications, and are non-returnable.

1963-65 Fairlane - 2 and 4 door Sedan  
(Stock # B53-64055-222)

**OEM # C3OZ-53700-62SPO each . 169.95**

1963-65 Fairlane - 2 door Hardtop and 500

(Stock # B53-64055-220)

**OEM # C3OZ-53700-65SPO each . 212.95**

1966 Comet - 2 door Hardtop and Sedan and 4 door Sedan with narrow deck only  
(Stock # X53-64055-229)

**OEM # C6DZ-53700-65SPO each . 169.95**

1966 Fairlane - 2 door Sedan narrow deck  
(Stock # B52-63075-180)

**OEM # C6OZ-53700-62SPO each . 169.95**

1966 Fairlane - 2 door Hardtop narrow deck only

(Stock # B52-63075-185)

**OEM # C6OZ-53700-65SPO each . 169.95**

1966-67 Comet - 2 door Sedan narrow deck only

(Stock # X53-64055-228)

**OEM # C6DZ-53700-62SPO each . 169.95**

1966-67 Comet - 4 door Sedan narrow deck only

(Stock # X53-64055-227)

**OEM # C6DZ-53700-54SPO each . 169.95**

1967 Fairlane - 2 door Sedan narrow deck  
(Stock # B53-64055-300)

**OEM # C7OZ-53700-62SPO each . 236.95**



## Vinyl Roof

1967 Fairlane - 2 door Hardtop with narrow deck

(Stock # B53-64055-310)

**OEM # C7OZ-53700-65SPO each . 236.95**

1967 Comet - 2 door Hardtop

(Stock # X53-64055-302)

**OEM # C7DZ-53700-65SPO each . 169.95**

1966-71 Ranchero

(Stock # B52-63075-190)

**OEM # C6OZ-53700-66SPO each . 169.95**

1968 Fairlane - 500 Fastback

1968-69 Torino - GT and Fastback 2 door hardtop

(Stock # B43-64055-430)

**OEM # C8OZ-53700-65SPO each . 169.95**

1968 Cyclone - 2 door Hardtop

(Stock # B53-64055-420)

**OEM # C8OZ-53700-64SPO each . 169.95**

1968-69 Torino - Notchback, Fastback and GT 4 door Hardtop and Sedan

1968-71 Montego - 4 door Sedan

(Stock # B53-64055-400)

**OEM # C8OZ-53700-62SPO each . 169.95**

1968-69 Fairlane - 2 door hardtop - except 500 Fastback

1968-69 Torino - Notchback

1968-71 Comet and Montego 2 door hardtop

1971 Cyclone - 2 door hardtop

(Stock # B53-64055-410)

**OEM # C8OZ-53700-63SPO each . 169.95**

1970-71 Fairlane and Torino - 4 door Hardtop and Sedan

1970-71 Montego - 4 door Hardtop and Sedan

(Stock # B53-64055-505)

**OEM # D0OZ-53700-62SPO each . 169.95**

1970-71 Fairlane and Torino

1970-71 Montego

(Stock # B53-64055-515)

**OEM # D0OZ-53700-65SPO each . 169.95**

1971 Comet - 4 door Sedan

(Stock # X53-64055-556)

**OEM # D1DZ-53700-54SPO each . 169.95**

1971 Comet - 2 door Hardtop

(Stock # X53-64055-558)

**OEM # D1DZ-53700-65SPO each . 169.95**

1972 Torino - 2 door Fastback Sedan and 4 door Sedan

(Stock # B53-64055-615)

**OEM # D2OZ-53700-54SPO each . 232.95**

1972 Torino - 2 door Hardtop Coupe

(Stock # B53-64055-625)

**OEM # D2OZ-53700-65SPO each . 232.95**

1972 Ranchero

(Stock # B53-64055-635)

**OEM # D2OZ-53700-97SPO each . 169.95**



## Convertible Hydraulic Pump and Motor Assembly

Fits behind seat area in the Convertible. This is a special order item and must be paid for in advance. Please allow 2-4 weeks for delivery.

1966-71 Fairlane and Torino

1965-66 Comet and Montego

(Stock # P53-64025-100)

**OEM # C4DZ-53337-76A . . . . . 289.95**

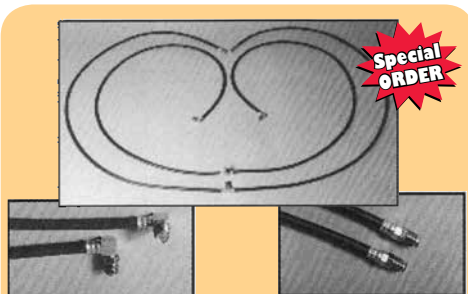

## Convertible Top Hydraulic Hose Kit

Pump to cylinder. This is a special order item and must be paid for in advance. Please allow 2-4 weeks for delivery.

1962-72 Convertible

(Stock # P53-64040)

**OEM # C0AZ-53392-76SPO kit . . . 49.95**

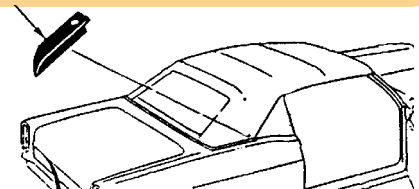

## Convertible Top Rail Rear Water Drains

1966-67 Fairlane - Convertible

1966-67 Comet - Convertible

(Stock # B53-64070-015)

**OEM # C6OZ-53988/9-76A each. . . 15.95**



## Quarter Window Roof Pads

1966-67 Fairlane - Convertible

1966-67 Comet - Convertible

(Stock # B54-64230)

**OEM # C6OZ-54784/5-76A pair . . . 19.95**

Please allow 7-14 days for Special Orders!

# 1962-72 Fairlane



## Shoulder Strap Boot

Front seat shoulder harness strap boot moulded in black plastic.

1971-73 Fairlane - except Convertible  
(Stock # P60-65055-005)

**OEM # D1AZ-60235-65H each . . . 6.95**



## Seat Belt Anchor Reinforcement

Anchors to floor pan.

1970 Fairlane - Convertible  
1967-70 Comet and Montego  
(Stock # P61-66065)

**OEM # C7AZ-61216-62B each. . . . 9.95**



## Seat Belt Retaining Loop

For front seat. In transparent plastic.

1963-64 Fairlane  
(Stock # P61-66070)

**OEM # C4AZ-61222-62AAB each . . . 0.00**



## Seat Back Adjustment Kit

Includes pair of chrome screw adjusters, nuts and washers, and heavy duty plastic rest plates.

1966-67 Fairlane  
(Stock # X61-66115-010)

**OEM # C1DZ-61643-64K kit . . . . 12.95**

**We accept these MAJOR credit cards.**



## Seat Side Hinge Covers

ABS plastic with original texture. Available in black. Paint to match interior. Includes mounting hardware.

1966-71 Fairlane, Torino and Ranchero - with bench seats  
(Stock # B61-66130-045) **(A) Price Reduced!**

**OEM # C6OZ-61694/5-62ACA pair 47.95**

1970-71 Torino and Ranchero - bucket seats

**Inner - (Stock # P61-66120) Price Reduced!**

**OEM # C8ZZ-61692/3-65B1A pair . 47.95**

**Outer - (Stock # B61-66130-050) (B)**

**OEM # D0OZ-61694/5-62ACA pair 47.95**



## Front Seat Track Adjusting Handle Knob

1962-69 Fairlane

1966-69 Comet and Montego  
(Stock # P61-66185-005)

**OEM # C5AZ-61753-62B each. . . . 3.95**



Classic Auto Parts has been serving your car and truck needs since 1974!

We appreciate our customers!

Check out our Swap Meet Schedule to see when we will be in your area. Maybe even save some on shipping. Call one of the guys for more information!



## Seat Track Latch Springs

Front seat tension springs.

1965-71 Fairlane - manual bucket seats  
(Stock # X61-66195-050)

**OEM # C0DB-61883-64C pair . . . 10.95**



## Retainer Clip for Seat Adjustment Knob

1965-69 Fairlane

1966-70 Comet and Montego  
(Stock # P62-67000)

**OEM # C5AZ-62060-62A each. . . . 2.95**

1966-71 Fairlane and Torino

1966-72 Comet and Montego

(Stock # B62-67000-005)

**OEM # C6OZ-62060-62A each . . . 1.95**



## Seat Latch Handle Kit

Exact reproduction seat latch handle used on 1968/1979 Rancheros and Torinos, and 1968/1972 Galaxies for both bucket and bench seat models. These little handles are triple chrome plated. Superior to the original Ford. Requires two per vehicle.

1968-72 Torino/Ranchero

1968-69 Comet and Montego - Fastback, hardtop and convertible

1970-71 Montego - hardtop

(Stock # P62-67070-005)

**OEM # C8AZ-62622/72-62A set . . . 26.95**

**I want you to check out our website for easy shopping and current prices for anything you may need. Don't**

**want to order on-line? Just give us a call and we'll be happy to help!**

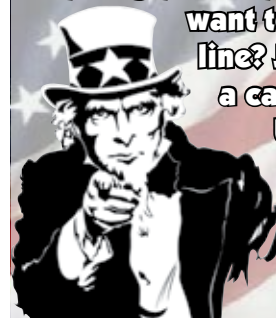

# 1962-72 Fairlane

Seat Parts



## Seat Belts

These kits are available with a polished chrome finished buckle lid. The buckle designs are an easy lift up release unit. Mounting anchors are snaps and require the use of eyebolt connectors for installation. Mounting hardware is included.

### Front Belts

- (Stock # P62-67130-045) - **Black**
- OEM # C0AZ-62900-62BLK** each . . . 42.95  
(Stock # P62-67131-030) - **Chestnut**
- OEM # C0AZ-62900-62CHE** each . . . 42.95  
(Stock # P62-67131-040) - **Chocolate**
- OEM # C0AZ-62900-62CHO** each . . . 42.95  
(Stock # P62-67131-050) - **Cream**
- OEM # C0AZ-62900-62CRM** each . . . 42.95  
(Stock # P62-67131-060) - **Dark Blue**
- OEM # C0AZ-62900-62DB** each . . . 42.95  
(Stock # P62-617131-070) - **Dark Green**
- OEM # C0AZ-62900-62DGR** each . . . 42.95  
(Stock # P62-67131-080) - **Dark Grey**
- OEM # C0AZ-62900-62DGY** each . . . 42.95  
(Stock # P62-67131-090) - **Flame Red**
- OEM # C0AZ-62900-62FR** each . . . . . 42.95  
(Stock # P62-67131-100) - **Gunmetal Grey**
- OEM # C0AZ-62900-62GGR** each . . . 42.95  
(Stock # P62-67131-110) **Ivory**
- OEM # C0AZ-62900-62IV** each . . . . . 42.95  
(Stock # P62-67131-120) **Light Grey**
- OEM # C0AZ-62900-62LTG** each . . . 42.95  
(Stock # P62-67131-130) - **Maroon**
- OEM # C0AZ-62900-62MA** each . . . 42.95  
(Stock # P62-67131-140) - **Olive Green**
- OEM # C0AZ-62900-62OLG** each . . . 42.95  
(Stock # P62-67131-150) - **Orange**
- OEM # C0AZ-62900-62OR** each . . . 42.95  
(Stock # P62-67131-160) - **Powder Blue**
- OEM # C0AZ-62900-62PB** each . . . . . 42.95  
(Stock # P62-67131-170) - **Purple**
- OEM # C0AZ-62900-62PR** each . . . . . 42.95  
(Stock # P62-67131-180) - **Royal Blue**
- OEM # C0AZ-62900-62RB** each . . . . . 42.95  
(Stock # P62-67131-190) - **Red**
- OEM # C0AZ-62900-62RD** each . . . 42.95  
(Stock # P62-67131-200) - **Tan**
- OEM # C0AZ-62900-62TA** each . . . . . 42.95  
(Stock # P62-67131-210) - **Teal**
- OEM # C0AZ-62900-62TL** each . . . . . 42.95  
(Stock # P62-67131-220) - **Turquoise**
- OEM # C0AZ-62900-62TQ** each . . . 42.95  
(Stock # P62-67131-230) - **Yellow**
- OEM # C0AZ-62900-62YE** each . . . . . 42.95



### Rear Seat Belts

- (Stock # P62-67130-240) **Black**
- OEM # C0AZ-62900-64BLK** each . . . 34.95  
(Stock # P62-67131-250) **Chestnut**
- OEM # C0AZ-62900-64CHE** each . . . 34.95  
(Stock # P62-67131-260) **Chocolate**
- OEM # C0AZ-62900-64CHO** each . . . 34.95  
(Stock # P62-67131-270) **Cream**
- OEM # C0AZ-62900-64CR** each . . . . . 34.95  
(Stock # P62-67131-280) **Dark Blue**
- OEM # C0AZ-62900-64DB** each . . . 34.95  
(Stock # P62-617131-290) **Dark Green**
- OEM # C0AZ-62900-64DGR** each . . . 34.95  
(Stock # P62-67131-300) **Dark Grey**
- OEM # C0AZ-62900-64DGY** each . . . 34.95  
(Stock # P62-67131-310) **Flame Red**
- OEM # C0AZ-62900-64FR** each . . . . . 34.95  
(Stock # P62-67131-320) **Gunmetal Grey**
- OEM # C0AZ-62900-64GGR** each . . . 34.95  
(Stock # P62-67131-330) **Ivory**
- OEM # C0AZ-62900-64IV** each . . . . . 34.95  
(Stock # P62-67131-340) **Light Grey**
- OEM # C0AZ-62900-64LTG** each . . . 34.95  
(Stock # P62-67131-350) **Maroon**
- OEM # C0AZ-62900-64MA** each . . . 34.95  
(Stock # P62-67131-360) **Olive Green**
- OEM # C0AZ-62900-64OGR** each . . . 32.95  
(Stock # P62-67131-370) **Orange**
- OEM # C0AZ-62900-64OR** each . . . 34.95  
(Stock # P62-67131-380) **Powder Blue**
- OEM # C0AZ-62900-64PB** each . . . . . 34.95  
(Stock # P62-67131-390) **Purple**
- OEM # C0AZ-62900-64PU** each . . . 32.95  
(Stock # P62-67131-400) **Royal Blue**
- OEM # C0AZ-62900-64RBL** each . . . 32.95  
(Stock # P62-67131-410) **Red**
- OEM # C0AZ-62900-64RD** each . . . 34.95  
(Stock # P62-67131-420) **Tan**
- OEM # C0AZ-62900-64TA** each . . . . . 34.95  
(Stock # P62-67131-430) **Teal**
- OEM # C0AZ-62900-64TL** each . . . . . 34.95  
(Stock # P62-67131-440) **Turquoise**
- OEM # C0AZ-62900-64TQ** each . . . 34.95  
(Stock # P62-67131-450) **Yellow**
- OEM # C0AZ-62900-64YE** each . . . . . 34.95

## Obsolete & Classic Auto Parts, Inc.

8701 South I-35  
Oklahoma City, OK 73149

### Summer Store Hours:

**Monday - Friday**  
8 a.m. thru 6 p.m.  
**Saturday**  
8 a.m. thru 12 p.m.

### Winter Store Hours:

**Monday - Friday**  
8 a.m. thru 5 p.m.  
**Saturday**  
8 a.m. thru 12 p.m.  
(Central Standard Time)

We accept VISA • DISCOVER  
MASTERCARD

check us out at  
[www.classicautoparts.com](http://www.classicautoparts.com)

**NEXT DAY AIR**  
service available  
on ALL orders!





### 1963 Fairlane Sports Coupe Front Seat Upholstery

This interior soft trim was meticulously reproduced to match original. We start with correct crush grain vinyl in factory colors and have all the correct seat pleat patterns and door panel chrome mylar made exactly like original. These are beautifully done and sure to help you win the trophies. Emblems sold separately.

**Available colors: Black - Red - Two Tone Blue - Light Gold**  
 (Stock # B62-67130-292) - front bucket seats  
**OEM # C30Z-62900-446 set . . . 629.95**  
 (Stock # B62-67135-150) - rear seats  
**OEM # C30Z-62901-461 set . . . 499.95**  
**Front and Rear - Sold in Set**  
 (Stock # B62-67145-555)  
**OEM # C30Z-62999-65S set . . . 589.95**



### 1964 Fairlane Sports Coupe Seat Upholstery

All of our upholstery is made to original specifications with correct grain vinyls in factory colors. All seams are stitched to perfection and feature original pleat patterns and heat sealed patterns where applicable. Our upholstery is concours quality and is being used in show cars nationwide. Our material is computer color matched for correct colors. Seat emblems sold separately.

**Available colors: Black - Red - Palomino - Blue - Pearl White**  
**Solid Color**  
 (Stock # B62-67130-316) - front bucket seats  
**OEM # C40Z-62900-495 set . . . 539.95**  
 (Stock # B62-67135-195) - rear seats  
**OEM # C40Z-62901-743 set . . . 399.95**  
**Two-Tone**  
 (Stock # P62-67130-317) - front bucket seats  
**OEM # C40Z-62900-719 set . . . 539.95**  
**Front and Rear - Sold in Set**  
 (Stock # B62-67145-556)  
**OEM # C40Z-62999-65S set . . . 799.95**

### 1964 Fairlane 500 Bench Seat Upholstery

This is the hard to find material that has not been offered up until now. We have accurately reproduced the interior to match original. Features correct crush grain vinyl, original dielectric embossed patterns in the seat covers and door panels. Door panels are die cut with correct perforations for door handles, armrest and window crank.

**Available colors: Black - Red - Two Tone Blue - Fawn.**  
 1964 Fairlane 500  
 (Stock # B62-67130-557) - Front Bench Seat  
**OEM # C40Z-62900-62S set . . . 349.95**  
 1964 Fairlane 500 Hardtop  
**Front and Rear Bench Set**  
 (Stock # B62-67145-557)  
**OEM # C40Z-62999-64S set . . . 799.95**  
 1964 Fairlane 500 Sedan  
**Front and Rear Bench Set**  
 (Stock # B62-67145-558)  
**OEM # C40Z-62999-62S set . . . 899.95**



### 1965 Fairlane 500 Seat Upholstery

All of our upholstery is made to original specifications with correct grain vinyls in factory colors. All seams are stitched to perfection and feature original pleat patterns and heat sealed patterns where applicable. Our upholstery is concours quality and is being used in show cars nationwide. Our material is computer color matched for correct colors. Seat emblems sold separately.

**Available colors: Black - Ivy Gold - Palomino - Red**  
 (Stock # B62-67130-337) - Front Bucket Seats  
**OEM # C50Z-62900-792 set . . . 529.95**  
 (Stock # B62-67130-338) - Front Bench Seats  
**OEM # C50Z-62900-818 set . . . 529.95**  
 (Stock # B62-67135-240) - Rear Buckets  
**OEM # C50Z-62901-800 set . . . 399.95**  
 (Stock # B62-67135-826) - Rear Bench  
**OEM # C50Z-62901-826 set . . . 339.95**



# 1962-72 Fairlane

Seat Parts



**Special Order**

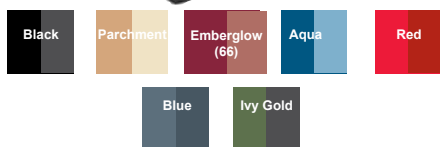

## 1966 Fairlane Seat Upholstery

Highest quality computer matched vinyls. Correct Sierra grain trim with original rosette pattern inserts to match the original seats exactly. Original buttons are NOT included. **Available colors: Black - Parchment - Emberglow - Aqua - Red - Blue - Ivy Gold**

(Stock # B62-67130-357) - front bucket - solid  
**OEM # C6OZ-62900-TT594 set . 499.95**

1966 Ranchero  
(Stock # X62-67130-347) - front bucket - solid  
**OEM # C6DZ-62900-255 set . . . 599.95**

Front rear bucket and rear bench - sold in set

(Stock # B62-67145-601) - Hardtop  
**OEM # C6OZ-62999-64S set . . . 559.95**

(Stock # B62-67145-602) - Convertible

**OEM # C6OZ-62999-76S set . . . 517.95**



**Special Order**



## 1966 Fairlane 500 Bench Seat Upholstery

This features the correct horizontal seat seal patterns and the original Sierra grain vinyl with Walrus grain inserts. All upholstery is vinyl as original and for 2 door models only.

**Available colors: Black - Red - Blue - Ivy Gold - Parchment**

(Stock # B62-67130-358) - front - solid  
**OEM # C6OZ-62900-602 set . . . 539.95**

1966 Ranchero  
(Stock # X62-67130-346) - front - solid  
**OEM # C6DZ-62900-263 set . . . 599.95**

1966 Fairlane 500 Convertible  
(Stock # B62-67135-610) - rear - solid  
**OEM # C6OZ-62901-76S set . . . 419.95**

1966 Fairlane 500 Hardtop  
(Stock # B62-67135-615) - rear - solid  
**OEM # C6OZ-62901-64S set . . . 329.95**

1966 Fairlane 500XL and 500 GT Hardtop  
(Stock # B62-67135-062) - rear - solid  
**OEM # C6OZ-62901-610 set . . . 329.95**

1966 Fairlane 500 Convertible  
(Stock # B62-67135-061) - rear - solid  
**OEM # C6OZ-62901-604 set . . . 329.95**

Front and Rear Bench Seats - Sold in Set  
(Stock # B62-67145-610) - Convertible  
**OEM # C6OZ-62999-76C set . . . 645.00**

(Stock # B62-67145-615) - Hardtop  
**OEM # C6OZ-62999-64H set . . . 645.00**



**Special Order**

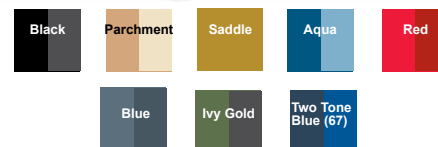

## 1967 Fairlane/Ranchero Bucket Seat Upholstery

These are a replacement for the original seat covers and not an exact reproduction. The original had an embossed pattern in the vinyl. This does not. This is made in the original Sierra grain vinyl with rosette insert, in the correct colors with the correct stitch pattern which works well as a nice replacement to the obsolete pattern. A high quality product made right here in the USA. Seat emblems sold separately.

**Available colors: Black - Parchment - Aqua - Red - Blue - Saddle - Two Tone Blue - Ivy Gold**

1967 Fairlane and Ranchero  
(Stock # B62-67130-396) - front - solid  
**OEM # C7OZ-62900-651 set . . . 529.95**

Front and Rear Buckets - Sold in Set  
(Stock # B62-67145-620) - Hardtop  
**OEM # C7OZ-62999-64S set . . . 517.95**

(Stock # B62-67145-625) - Convertible  
**OEM # C7OZ-62999-76S set . . . 517.95**

*Thanks*

## NOTE:

ALL Upholstery is Special Order. It is made to your exact specifications making it a NON Returnable item. It carries the manufacturers warranty guaranteeing quality and fit but it is made to order and drop shipped directly to your door.

Please allow 10-14 days on delivery for any Special Order Upholstery.

# 1962-72 Fairlane



## 1967 Fairlane 500 Bench Seat Upholstery

1967 Fairlane 500 models can be very difficult to restore due to original soft trim scarcity. We are proud to introduce concours quality soft trim that will make your car a show stopper. We have replicated the original seat patterns using sierra grain vinyl in original colors.

Available colors: Black - Red - Two Tone Blue - Two Tone Aqua - Parchment.

1967 Fairlane and Ranchero (Stock # B62-67130-398) - **Front Bench Seat**  
**OEM # C7OZ-62900-669 set . . . . . 529.95**

1967 Fairlane 500 Hardtop (Stock # B62-67135-066) - **rear - solid**  
**OEM # C7OZ-62901-701 set . . . . . 339.95**

1967 Fairlane 500 Convertible (Stock # B62-67135-275) - **rear - solid**  
**OEM # C7OZ-62901-TT693 set . . . . . 339.95**

1967 Fairlane 500XL and 500 GT Hardtop (Stock # B62-67135-265) - **rear - two-tone**  
**OEM # C7OZ-62901-TT677 set . 339.95**

1967 Fairlane 500XL and 500 GT Convertible (Stock # B62-67135-270) - **rear - two-tone**  
**OEM # C7OZ-62901-TT685 set . 339.95**

**Front and Rear Bench - sold in set**

1967 Fairlane 500 Hardtop (Stock # B62-67145-112) **New!**  
**OEM # C7OZ-62999-63A set . . . . . 745.00**



## 1968 Torino/Ranchero Bucket Seat Upholstery

All of our upholstery is made to original specifications with correct grain vinyls in factory colors. All seams are stitched to perfection and feature original pleat patterns and heat sealed patterns where applicable. Our upholstery is concours quality and is being used in show cars nationwide. Our material is computer color matched for correct colors.

Available colors: Black - Blue - Ivy Gold - Nugget Gold - Parchment - Red - Turquoise - White

1968 Torino and Ranchero (Stock # B62-67130-611) - **front**  
**OEM # C8OZ-62900-859 set . . . . . 539.95**

1968 Torino Fastback (Stock # B62-67135-295) - **rear - solid**  
**OEM # C8OZ-62901-933 set . . . . . 319.95**

1968 Torino Convertible (Stock # B62-67135-300) - **rear - solid**  
**OEM # C8OZ-62901-941 set . . . . . 319.95**



## 1968 Torino/Ranchero Bench Seat Upholstery

All of our upholstery is made to original specifications with correct grain vinyls in factory colors. All seams are stitched to perfection and feature original pleat patterns and heat sealed patterns where applicable. Our upholstery is concours quality and is being used in show cars nationwide. Our material is computer color matched for correct colors.

Available colors: Black - Blue - Ivy Gold - Nugget Gold - Parchment - Red - Turquoise - White

1968 Torino and Ranchero (Stock # B62-67130-612) - **front - solid**  
**OEM # C8OZ-62900-867 set . . . . . 539.95**

1968 Torino Fastback (Stock # B62-67135-285) - **rear - solid**  
**OEM # C8OZ-62901-875 set . . . . . 329.95**

1968 Torino Convertible (Stock # B62-67135-290) - **rear - solid**  
**OEM # C8OZ-62901-883 set . . . . . 329.95**

## NOTE:

ALL Upholstery is Special Order. It is made to your exact specifications making it a NON Returnable item. It carries the manufacturers warranty guaranteeing quality and fit but it is made to order and drop shipped directly to your door.

Please allow 10-14 days on delivery for any Special Order Upholstery.



# 1962-72 Fairlane

Seat Parts



## 1969 Torino/Ranchero Bucket Seat Upholstery

All of our upholstery is made to original specifications with correct grain vinyls in factory colors. All seams are stitched to perfection and feature original pleat patterns and heat sealed patterns where applicable. Our upholstery is concours quality and is being used in show cars nationwide. Our material is computer color matched for correct colors.

Available colors: Black - Blue - Ivy Gold - Nugget Gold - Parchment - Red - Turquoise - White

1969 Torino and Ranchero  
(Stock # B62-67130-616) - front - solid

**OEM # C9OZ-62900-917 set . . . . . 459.95**

## 1969 Torino/Ranchero Bench Seat Upholstery

All of our upholstery is made to original specifications with correct grain vinyls in factory colors. All seams are stitched to perfection and feature original pleat patterns and heat sealed patterns where applicable. Our upholstery is concours quality and is being used in show cars nationwide. Our material is computer color matched for correct colors.

Available colors: Black - Blue - Ivy Gold - Nugget Gold - Parchment - Red - Turquoise - White

1969 Torino and Ranchero  
(Stock # B62-67130-617) - Front

**OEM # C9OZ-62900-925 set . . . . . 459.95**

1969 Torino Fastback  
(Stock # B62-67135-295) - rear

**OEM # C8OZ-62901-933 set . . . . . 319.95**

1969 Torino Convertible  
(Stock # B62-67135-300) - rear

**OEM # C8OZ-62901-941 set . . . . . 319.95**

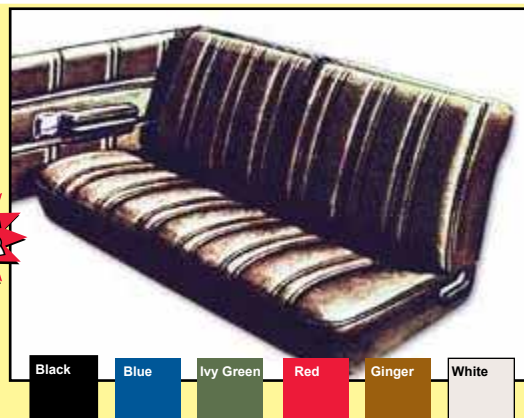

## 1970 Torino/Ranchero Bucket Seat Upholstery

All of our upholstery is made to original specifications with correct grain vinyls in factory colors. All seams are stitched to perfection and feature original pleat patterns and heat sealed patterns where applicable. Our upholstery is concours quality and is being used in show cars nationwide. Our material is computer color matched for correct colors

Available colors: Black - Blue - Ginger - Ivy Green - Red - White

1970 Torino and Ranchero  
(Stock # B62-67130-619) - front

**OEM # D0OZ-62900-966 set . . . . . 574.95**

1970 Torino Fastback  
(Stock # B62-67135-320) - rear

**OEM # D0OZ-62901-982 set . . . . . 389.95**

1970 Torino Convertible  
(Stock # B62-67135-325) - rear

**OEM # D0OZ-62901-990 set . . . . . 399.95**

Front Bucket and Rear - sold in set

1970 Torino Fastback  
(Stock # B62-67145-663)



**OEM # D0OZ-62999-63S set . . . . . 735.00**

1970 Torino Convertible  
(Stock # B62-67145-667)



**OEM # D0OZ-62999-76S set . . . . . 735.00**

## 1970 Torino/Ranchero Bench Seat Upholstery

All of our upholstery is made to original specifications with correct grain vinyls in factory colors. All seams are stitched to perfection and feature original pleat patterns and heat sealed patterns where applicable. Our upholstery is concours quality and is being used in show cars nationwide. Our material is computer color matched for correct colors

Available colors: Black - Blue - Ginger - Ivy Green - Red - White

1970 Torino  
(Stock # B62-67130-621) - front

**OEM # D0OZ-62900-974 each . . . 459.95**

1970 Ranchero  
(Stock # B62-67130-618) - front



**OEM # D0OZ-62900-162 each . . . 471.95**

1970 Torino Fastback  
(Stock # B62-67135-310) - rear

**OEM # D0OZ-62901-006 each . . . 329.95**

1970 Torino Convertible  
(Stock # B62-67135-315) - rear

**OEM # D0OZ-62901-014 each . . . 329.95**

Front and Rear - sold in set

1970 Torino Fastback  
(Stock # B62-67145-661)



**OEM # D0OZ-62999-63BS set . . . 549.95**

1970 Torino Convertible  
(Stock # B62-67145-665)



**OEM # D0OZ-62999-76BS set . . . 549.95**

## NOTE:

ALL Upholstery is Special Order. It is made to your exact specifications making it a NON Returnable item. It carries the manufacturers warranty guaranteeing quality and fit but it is made to order and drop shipped directly to your door.

Please allow 10-14 days on delivery for any Special Order Upholstery.

# 1962-72 Fairlane

**Special  
ORDER**



**Special  
ORDER**

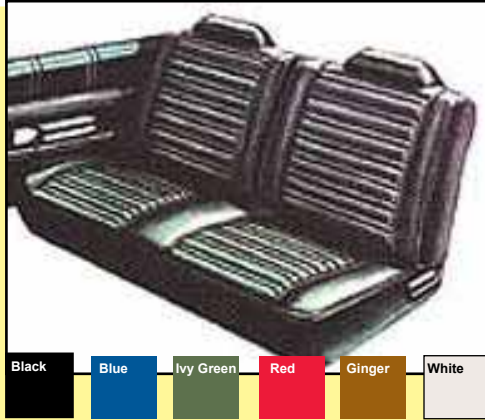

**Seat Parts**

## 1971 Torino/Ranchero Bucket Seat Upholstery

All of our upholstery is made to original specifications with correct grain vinyls in factory colors. All seams are stitched to perfection and feature original pleat patterns and heat sealed patterns where applicable. Our upholstery is concours quality and is being used in show cars nationwide. Our material is computer color matched for correct colors

**Available colors: Black - Blue - Ginger - Ivy Green - Red - White**

1971 Torino and Ranchero

(Stock # B62-67130-622) - front

**OEM # D10Z-62900-022 set . . . . . 579.95**

1971 Torino Fastback

(Stock # B62-67135-327) - rear

**OEM # D10Z-62901-048 set . . . . . 389.95**

1971 Torino Convertible

(Stock # B62-67135-055) - rear

**OEM # D10Z-62901-055 set . . . . . 329.95**

**Front and Rear - sold in set**

1971 Torino Fastback

(Stock # B62-67145-684)

**OEM # D10Z-62999-63S set . . . . . 735.00**

1971 Torino Convertible

(Stock # B62-67145-686)

**OEM # D10Z-62999-76S set . . . . . 735.00**

**New!**

**New!**

## 1971 Torino/Ranchero Bench Seat Upholstery

All of our upholstery is made to original specifications with correct grain vinyls in factory colors. All seams are stitched to perfection and feature original pleat patterns and heat sealed patterns where applicable. Our upholstery is concours quality and is being used in show cars nationwide. Our material is computer color matched for correct colors

**Available colors: Black - Blue - Ginger - Ivy Green - Red - White**

1971 Torino

(Stock # B62-67130-623) - front

**OEM # D10Z-62900-030 each . . . 459.95**

1971 Ranchero

(Stock # B62-67130-618) - front

**Price  
Reduced!**

**OEM # D00Z-62900-162 each . . . 471.95**

1971 Torino Fastback

(Stock # B62-67135-039) - rear

**OEM # D10Z-62901-063 each . . . 329.95**

1971 Torino Convertible

(Stock # ) - rear

**OEM # D10Z-62901-071 each . . . 299.00**

**Front and Rear - sold in set**

1971 Torino Fastback

(Stock # B62-67145-682)

**OEM # D10Z-62999-63BS set . . . 549.95**

1971 Torino Convertible

(Stock # B62-67145-688)

**OEM # D10Z-62999-76BS . . . . . 500.00**

**New!**

**New!**

## 1972 Torino/Ranchero Bucket Seat Upholstery

All of our upholstery is made to original specifications with correct grain vinyls in factory colors. All seams are stitched to perfection and feature original pleat patterns and heat sealed patterns where applicable. Our upholstery is concours quality and is being used in show cars nationwide. Our material is computer color matched for correct colors.

**Available colors: Black - Blue - Ginger - Green - Maroon - White**

1972 Torino and Ranchero - with Comfortweave

(Stock # B62-67130-624) - front

**OEM # D20Z-62900-089 set . . . . . 589.95**

1972 Torino Hardtop - with Comfortweave

(Stock # B62-67135-335) - rear

**OEM # D20Z-62901-105 set . . . . . 399.95**

## 1972 Torino/Ranchero Bench Seat Upholstery

All of our upholstery is made to original specifications with correct grain vinyls in factory colors. All seams are stitched to perfection and feature original pleat patterns and heat sealed patterns where applicable. Our upholstery is concours quality and is being used in show cars nationwide. Our material is computer color matched for correct colors

**Available colors: Black - Blue - Ginger - Green - Maroon - White**

1972 Torino and Ranchero - Standard split bench

(Stock # B62-67130-626) - front

**OEM # D20Z-62900-097 each . . . 469.95**

1972 Torino and Ranchero - GT split bench

(Stock # B62-67130-627) - front

**OEM # D20Z-62900-204 each . . . 469.95**

1972 Torino Standard

(Stock # B62-67135-701) - rear

**OEM # D20Z-62901-113 each . . . 329.95**

1972 Torino GT

(Stock # B62-67135-340) - rear

**OEM # D20Z-62901-212 each . . . 329.95**

## NOTE:

ALL Upholstery is Special Order. It is made to your exact specifications making it a NON Returnable item. It carries the manufacturers warranty guaranteeing quality and fit but it is made to order and drop shipped directly to your door.

Please allow 10-14 days on delivery for any Special Order Upholstery.

# 1962-72 Fairlane

Seat Parts



### Bucket Seat Foam Sets

High quality molded seat foam engineered to match your original foam buns exactly. Includes one top, and one bottom. Two required per vehicle.

1964 Fairlane Sports Coupe **Price Reduced!**  
(Stock # B62-67137-185)

**OEM # C4OZ-62902-65BSF set . . . 218.95**

1966-67 Fairlane

1967 Ranchero **Price Reduced!**  
(Stock # B62-67138-200)

**OEM # C6OZ-62902-62BSF each . . 149.95**



### Seat Upholstery Emblem

These are manufactured to match the original die cast emblems, and are plated and painted to original.

1963 Fairlane  
(Stock # B64-69050-010)

**OEM # C3OZ-64824-65A each . . 69.95**



### Seat Upholstery Emblem

These are manufactured to match the original die cast emblems, and are plated and painted to original.

1964 Fairlane  
(Stock # B64-69050-020)

**OEM # C4OZ-64824-62A each . . 17.95**



### Seat Upholstery Emblem

These are manufactured to match the original die cast emblems, and are plated and painted to original.

1966 Fairlane  
(Stock # B64-69050-024)

**OEM # C6OZ-64824-63 each . . . . 9.95**



### Seat Upholstery Emblem

These are manufactured to match the original die cast emblems, and are plated and painted to original.

1967 Fairlane  
(Stock # B64-69050-025)

**OEM # C7OZ-64824-63A each . . 17.95**



### Seat Upholstery Emblem

These are manufactured to match the original die cast emblems, and are plated and painted to original.

1968 Torino & Ranchero  
(Stock # B64-69050-030)

**OEM # C8OZ-64824-54A each . . 17.95**



### Seat Upholstery Emblem

These are manufactured to match the original die cast emblems, and are plated and painted to original.

1969 Torino & Ranchero  
(Stock # B64-69050-045)

**OEM # C9OZ-64824-63A each . . 17.95**



We love when our customers bring their cars and trucks by. Feel free to drive yours up and show it off.



# 1962-72 Fairlane



**Bolt Kits**

## Master Engine Kit

These kits include fasteners to attach: air cleaner, carburetor, crank pulley, distributor, engine tag, exhaust manifolds, fan, clutch, fuel pump, heat shroud, ignition coil, intake manifold, oil filter adapter, oil pan, starter, timing cover, valve covers, water neck and water pump. Additional small block kits include a detailed water pump bolt placement illustration.

1962-65 Fairlane - 170 and 200

(Stock # X80-73430-055)

**OEM # C06E-80800-319 kit ... 119.95**

1962-65 Fairlane - 221, 260 and 289 -  
with generator exhaust locks

(Stock # B80-73430-065)

**OEM # C20E-80800-322 kit ... 189.95**

1962-65 Fairlane - 221, 260 and 289  
- with generator, air conditioner, and  
exhaust locks

(Stock # B80-73430-070)

**OEM # C20E-80800-336 kit ... 155.95**

1962-72 Fairlane - 250

(Stock # X80-73430-210)

**OEM # C9DE-80800-342 kit ... 119.95**

1963-65 Fairlane - 289 HP - with genera-  
tor and exhaust locks

(Stock # B80-73430-100)

**OEM # C30E-80800-323 kit ... 129.95**

1965 Fairlane - 289 HP - iron WP with  
alternator and exhaust locks

(Stock # S80-73430-125)

**OEM # C5ZE-80800-1067 kit ... 129.95**

1965 Fairlane - 289 - aluminum WP with  
generator and exhaust locks

(Stock # B80-73430-105)

**OEM # C50E-80800-559 kit ... 189.95**

1965 Fairlane - 289 - with aluminum  
WP with alternator, air conditioning and  
exhaust locks

(Stock # B80-73430-110)

**OEM # C50E-80800-560 kit ... 189.95**

1965 Fairlane - 289 - iron WP with alter-  
nator and exhaust locks

(Stock # B80-73430-120)

**OEM # C50E-80800-812 kit ... 189.95**

1965 Fairlane - 289 - aluminum WP with  
alternator, AC, and exhaust locks

(Stock # B80-73430-115)

**OEM # C50E-80800-561 kit ... 129.95**

1966 Fairlane - 289 - cast iron WP with sir  
conditioning and ramp locks

(Stock # B80-73430-150)

**OEM # C60E-80800-337 kit ... 184.95**

1966-67 Fairlane - 170 and 200

(Stock # X80-73430-135)

**OEM # C6DE-80800-320 kit ... 109.95**

1966-67 Fairlane - 289 - cast iron WP and  
ramp locks

(Stock # B80-73430-140)

**OEM # C60E-80800-324 kit ... 184.95**

1966-67 Fairlane - 390 GT

(Stock # B80-73430-145)

**OEM # C60E-80800-329 kit ... 165.95**

1966-67 Fairlane - 427

(Stock # B80-73430-155)

**OEM # C60E-80800-789 kit ... 179.95**

1967 Fairlane - 289 - with air conditioning

(Stock # B80-73430-165)

**OEM # C70E-80800-562 kit ... 189.95**

1967 Fairlane - 390 GT

(Stock # B80-73430-160)

**OEM # C70E-80800-330 kit ... 156.95**

1968 Fairlane - 289 and 302

(Stock # B80-73430-175)

**OEM # C80E-80800-326 kit ... 189.95**

1968 Fairlane - 289 and 302 - with air  
conditioning

(Stock # B80-73430-190)

**OEM # C80E-80800-338 kit ... 189.95**

1968 Fairlane - 428 CJ

(Stock # B80-73430-185)

**OEM # C80E-80800-333 kit ... 156.95**

1968-69 Fairlane - 390 GT

(Stock # B80-73430-180)

**OEM # C80E-80800-332 kit ... 156.95**

Master Engine Kits - Continued

1968-70 Fairlane - 170 and 200

(Stock # X80-73430-170)

**OEM # C8DE-80800-321 kit ... 119.95**

1969 Fairlane - 302

(Stock # B80-73430-215)

**OEM # C90E-80800-1126 kit ... 189.95**

1969 Fairlane - 302 with air conditioning

(Stock # B80-73430-220)

**OEM # C90E-80800-1127 kit ... 189.95**

1969 Fairlane - 351 - without air conditioning

(Stock # B80-73430-225)

**OEM # C90E-80800-1128 kit ... 189.95**

1969 Fairlane - 351 - with air conditioning

(Stock # B80-73430-230)

**OEM # C90E-80800-1129 kit ... 189.95**

1969 Fairlane - 428 CJ and SCJ

(Stock # B80-73430-235)

**OEM # C90E-80800-334 kit ... 156.95**

1970 Torino - 302

(Stock # B80-73430-240)

**OEM # D00E-80800-1130 kit ... 129.95**

1970-71 Fairlane - 429 CJ and SCJ

(Stock # B80-73430-260)

**OEM # D00E-80800-1183 kit ... 169.95**

1970-71 Torino - 351C 2V

(Stock # B80-73430-250)

**OEM # D00E-80800-1175 kit ... 129.95**

1970-71 Torino - 351C 4V

(Stock # B80-73430-255)

**OEM # D00E-80800-1176 kit ... 129.95**

1970-73 Torino - 351W

(Stock # B80-73430-245)

**OEM # D00E-80800-1132 kit ... 129.95**

1971-73 Torino - 302

(Stock # B80-73430-265)

**OEM # D10E-80800-3662 kit ... 129.95**

1972-73 Torino - 351C 2V

(Stock # B80-73430-270)

**OEM # D20E-80800-1178 kit ... 129.95**

1972-73 Fairlane - 351C 4V

(Stock # B80-73430-275)

**OEM # D20E-80800-1179 kit ... 129.95**

# 1962-72 Fairlane

Bolt Kits

## Stainless Engine Bolt Kit

Every engine kit includes component kits for the distributor, fuel pump, intake, oil pan, thermostat, timing chain housing, valve covers, and water pump.

351M and 400M engines - with sheet metal covers  
(Stock # B80-73431-210) - **button and socket head**

**OEM # C2OZ-80800-0550 kit . . . 41.95**  
(Stock # B80-73431-220) - **hex head**

**OEM # C2OZ-80800-0551 kit . . . 54.95**  
351M and 400M - with cast valve covers -  
(Stock # V80-73431-230) - **button and socket head**

**OEM # C2OZ-80800-0683 kit . . . 48.95**  
(Stock # B80-73431-240) - **hex head**

**OEM # C2OZ-80800-0684 kit . . . 53.95**  
351W - passenger side water pump inlet -  
with cast aluminum valve covers  
(Stock # B80-73431-250) - **hex/indented hex head**

**OEM # C2OZ-80800-0787 kit . . . 59.95**  
with sheet metal valve covers  
(Stock # B80-73431-260) - **hex/indented hex head**

**OEM # C2OZ-80800-0792 kit . . . 61.95**  
Small block Ford® with passenger side  
water pump inlet  
with cast aluminum valve covers  
(Stock # B80-73430-080) - **hex head**

**OEM # C2OZ-80800-0887 kit . . . 75.95**  
with sheet metal valve covers  
(Stock # B80-73430-085) - **hex head**

**OEM # C2OZ-80800-0925 kit . . . 61.95**  
302 with driver side water pump inlet  
with cast aluminum valve covers  
(Stock # B80-73431-270) - **hex/indented hex head**

**OEM # C2OZ-80800-0996 kit . . . 57.95**  
with sheet metal valve covers  
(Stock # B80-73431-280) - **hex/indented hex head**

**OEM # C2OZ-80800-0997 kit . . . 57.95**  
Ford® FE  
with sheet metal valve covers  
(Stock # P80-73430-095) - **hex head**

**OEM # C3AZ-80800-0601 kit . . . 71.95**  
with aluminum valve covers  
(Stock # P80-73431-290) - **hex head**

**OEM # C3AZ-80800-0699 kit . . . 79.95**



351C  
with cast valve covers  
(Stock # B80-73431-300) - **button and socket head**

**OEM # C5OZ-80800-0673 kit . . . 52.95**  
(Stock # B80-73431-310) - **hex head**

**OEM # C5OZ-80800-0674 kit . . . 57.95**  
with sheet metal valve covers  
(Stock # B80-73431-320) - **button and socket head**

**OEM # C5OZ-80800-0678 kit . . . 52.95**  
(Stock # B80-73431-330) - **hex head**

**OEM # C5OZ-80800-0679 kit . . . 57.95**  
429/460  
with sheet metal valve cover  
(Stock # B80-73431-340) - **button and socket head**

**OEM # C8OZ-80800-0700 kit . . . 62.95**  
(Stock # B80-73430-195) - **hex head**

**OEM # C8OZ-80800-0701 kit . . . 65.95**  
with cast valve cover  
(Stock # B80-73431-350) - **button and socket head**

**OEM # C8OZ-80800-0721 kit . . . 62.95**  
(Stock # B80-73431-360) - **hex head**

**OEM # C8OZ-80800-0722 kit . . . 65.95**  
351W with drivers side water pump inlet  
with sheet metal valve covers  
(Stock # B80-73430-200) - **hex head**

**OEM # C8OZ-80800-0829 kit . . . 78.95**  
with cast aluminum valve covers  
(Stock # B80-73430-205) - **hex head**

**OEM # C8OZ-80800-0899 kit . . . 61.95**



## Master Body Kit

A typical kit includes fasteners to attach the battery tray, bumper guards, bumper guard brackets, cowl braces, cowl panel, door hinges, strikers, latches, fenders, fender splash shields, fender extensions, floorboard plates, grill, grill supports, head lamp doors, head lamp housings, hood, hood hinges, hood latch, hood latch catch, hood latch catch support, outside mirrors, quarter extensions, stone deflectors, suspension bumper brackets, trunk latch, latch striker plate, trunk, trunk lid hinges, and front and rear valance. All kits include all related spring nuts and clips.

1966 Fairlane  
(Stock # B80-73435-085) - **269 pieces**

**OEM # C6OB-80801-63K kit . . . 255.95**  
1966-67 Comet

(Stock # X80-73435-080) - **269 pieces**

**OEM # C6GB-80801-63K kit . . . 229.95**  
1967 Fairlane

(Stock # B80-73435-100) - **269 pieces**

**OEM # C7OB-80801-63K kit . . . 275.95**  
1968 Fairlane

(Stock # B80-73435-130) - **269 pieces** **Price Reduced!**

**OEM # C8OB-80801-63K kit . . . 255.95**  
1969 Fairlane

(Stock # B80-73435-145) - **269 pieces**

**OEM # C9OB-80801-63K kit . . . 255.95**



## Stainless Steel C4 Cast Aluminum Transmission Pan Bolt Kit

Ford® and Mercury® C4 transmission  
(Stock # R80-73450)

**OEM # SR-80811-0900 set . . . . . 6.95**

## Stainless Steel C4 Sheet Metal Stock or Chrome Transmission Pan Bolt Kit

Ford® and Mercury® C4 transmission  
(Stock # R80-73450-005)

**OEM # SR-80811-0903 set . . . . . 6.95**

**Friend us on Facebook and follow us on Twitter. You never know what you might be in for.**



# 1962-72 Fairlane



## Stainless Steel C6 Cast Aluminum Transmission Pan Bolt Kit

Ford® and Mercury® C6 transmission  
(Stock # R80-73450-010)  
**OEM # SR-80811-0906 set . . . . . 10.95**

## Stainless Steel C6 Hydromatic Pan Kit

Ford® and Mercury® C6 transmission  
(Stock # R80-73450-015)  
**OEM # SR-80811-0909 set . . . . . 9.95**



## Turbo Hydromatic Transmission Pan Bolt kit

Ford® and Mercury® 350-400  
(Stock # R80-73450-020) - stainless steel  
**OEM # SR-80811-5503 set . . . . . 7.95**

Sheet metal - stock or chrome  
Ford® and Mercury® 350-400  
(Stock # R80-73450-025)  
**OEM # SR-80811-5506 kit . . . . . 5.95**

700 R-4 Sheet metal - stock or chrome pan  
Ford® and Mercury® 700 R-4  
(Stock # R80-73450-030)  
**OEM # SR-80811-5553 kit . . . . . 9.95**

Cast aluminum pan  
Ford® and Mercury® 700 R-4  
(Stock # R80-73450-035)  
**OEM # SR-80811-5556 kit . . . . . 9.95**



## Tube Nuts

$\frac{3}{32}$ " stud size  
(Stock # P90-74015-005) - package of 10  
**OEM # C0AZ-99992-B pkg . . . . . 2.95**



## Cotter Pin

Front wheel spindle nut cotter pin  
(Stock # V70-72000)  
**OEM # B-72054-S each . . . . . .30**

**Online order is available 24/7!**  
**www.ClassicAutoParts.com**



## Interior Trim Screw Kit

These kits include all the exposed screws inside the car. For example: dash screws, interior molding screws, kick panel screws, etc.

1962 Fairlane - 2 door Sedan  
(Stock # B80-73500-405) - **74 pieces**  
**OEM # C2OZ-80902-70 kit . . . . . 29.95**

1962-63 Fairlane - 4 door Sedan  
1963 Meteor - 4 door Sedan  
(Stock # B80-73500-410) - **78 pieces**  
**OEM # C2OZ-80902-73 kit . . . . . 29.95**

1963 Fairlane - 2 door Hardtop  
(Stock # B80-73500-455) - **55 pieces**  
**OEM # C3OZ-80902-64 kit . . . . . 19.95**

1964-65 Fairlane - 2 door Sedan  
(Stock # B80-73500-485) - **61 pieces**  
**OEM # C4OZ-80902-70 kit . . . . . 23.95**

1964-65 Fairlane - 4 door Sedan  
(Stock # B80-73500-490) - **83 pieces**  
**OEM # C4OZ-80902-73 kit . . . . . 29.95**

1966 Fairlane - 2 door Sedan  
(Stock # B80-73500-570) - **39 pieces**  
**OEM # C6OZ-80902-62 kit . . . . . 19.95**

1966 Ranchero  
(Stock # B80-73500-575) - **61 pieces**  
**OEM # C6OZ-80902-66 kit . . . . . 22.95**

1966 Fairlane - 2 door Sedan  
(Stock # B80-73500-580) - **64 pieces**  
**OEM # C6OZ-80902-70 kit . . . . . 22.95**

1966 Fairlane - 500 Convertible  
(Stock # B80-73500-585) - **56 pieces**  
**OEM # C6OZ-80902-76 kit . . . . . 18.95**

1968-69 Fairlane - 2 door Fastback  
(Stock # B80-73500-625) - **99 pieces**  
**OEM # C8OZ-80902-63 kit . . . . . 24.95**

1968-69 Fairlane - 2 door Hardtop  
(Stock # B80-73500-630) - **75 pieces**  
**OEM # C8OZ-80902-65 kit . . . . . 25.95**

1968-69 Fairlane - 4 door Sedan  
(Stock # B80-73500-635) - **49 pieces**  
**OEM # C8OZ-80902-73 kit . . . . . 16.95**

1969 Ranchero  
(Stock # B80-73500-642)  
**OEM # C9OZ-80902-97 kit . . . . . 28.95**

1970 Fairlane - 2 door Hardtop  
(Stock # B80-73500-650) - **110 pieces**  
**OEM # D0OZ-80902-65 kit . . . . . 34.95**

1970-71 Fairlane - Convertible  
(Stock # B80-73500-660) - **102 pieces**  
**OEM # D0OZ-80902-76 kit . . . . . 27.95**

1972-73 Torino - Sport 2 door Hardtop  
(Stock # B80-73500-665) - **98 pieces**  
**OEM # D2OZ-80902-65 kit . . . . . 25.95**



## Interior Console Screw Set

1970-71 Fairlane and Torino  
(Stock # B80-73500-655) - **10 pieces**  
**OEM # D0OZ-80902-70CK kit . . . . 4.95**



1970 Fairlane

## Under Hood and Trunk Bolt Kit

1962 Fairlane  
(Stock # B80-73510-050) - **288 pieces**  
**OEM # C2OZ-80904-62 kit . . . . 188.95**

1966 Ranchero  
(Stock # B80-73510-060) - **170 pieces**  
**OEM # C6OZ-80904-66 kit . . . . 127.95**

1970 Fairlane  
(Stock # B80-73510-085) - **285 pieces**  
**OEM # D0OZ-80904-62 kit . . . . 238.95**

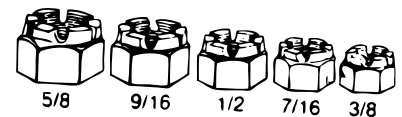

## Castellated Nuts

Just like originals!  
(Stock # T80-73000) -  $\frac{1}{2}$ "  
**OEM # T-80000-1/2 each . . . . . .95**  
(Stock # T80-73000-005) -  $\frac{3}{8}$ "  
**OEM # T-80000-3/8 each . . . . . .95**  
(Stock # T80-73000-010) -  $\frac{5}{8}$ "  
**OEM # T-80000-5/8 each . . . . . 1.50**  
(Stock # T80-73000-015) -  $\frac{7}{16}$ "  
**OEM # T-80000-7/16 each . . . . . .95**  
(Stock # T80-73000-020) -  $\frac{9}{16}$ "  
**OEM # T-80000-9/16 each . . . . . 1.95**

**When you need your parts yesterday, we understand! We offer several different options for Air Delivery. Inquire when placing your order.**

# 1962-72 Fairlane

Bolt Kits

## Exterior Screw Kit

Kits will vary with body style changes and accessories, but most large kits will include: grill screws, headlight mounting screws, mirror screws, parking light bezel and lens screws, quarter panel molding screws, tail light lens screws and windshield molding screws.

- 1962 Fairlane  
(Stock # B80-73515-120) - 32 pieces  
**OEM # C2OZ-80905-62 kit . . . . 14.95**
- 1962 Meteor  
(Stock # B80-73515-125) - 30 pieces  
**OEM # C2OZ-80905-70 kit . . . . 12.95**
- 1964-65 Fairlane  
(Stock # B80-73515-165) - 42 pieces  
**OEM # C4OZ-80905-62 kit . . . . 17.95**
- 1966 Fairlane  
(Stock # B80-73515-195) - 25 pieces  
**OEM # C6OZ-80905-62 kit . . . . 11.95**
- 1966 Ranchero  
(Stock # B80-73515-200) - 78 pieces  
**OEM # C6OZ-80905-66 kit . . . . 35.95**
- Extended kit with wheel well screws
- 1966 Ranchero  
(Stock # B80-73515-205) - 106 pieces  
**OEM # C6OZ-80905-66A kit . . . . 39.95**
- 1966 Fairlane - 500 Convertible  
(Stock # B80-73515-210) - 25 pieces  
**OEM # C6OZ-80905-76 kit . . . . 11.95**
- 1968 Fairlane  
(Stock # B80-73515-240) - 12 pieces  
**OEM # C8OZ-80905-62A kit . . . . 7.95**



- Extended kit with wheel well screws
- 1968 Fairlane  
(Stock # B80-73515-245) - 44 pieces  
**OEM # C8OZ-80905-62B kit . . . . 18.95**
- 1970 Fairlane  
(Stock # B80-73515-270) - 25 pieces  
**OEM # D0OZ-80905-65A kit . . . . 8.95**
- Extended kit with wheel well screws
- 1970 Fairlane  
(Stock # B80-73515-275) - 57 pieces  
**OEM # D0OZ-80905-65B kit . . . . 22.95**
- 1971 Torino  
(Stock # B80-73515-280) - 25 pieces  
**OEM # D1OZ-80905-65A kit . . . . 9.95**
- 1971 Torino - Extended kit with wheel well screws  
(Stock # B80-73515-285) - 59 pieces  
**OEM # D1OZ-80905-65B kit . . . . 25.95**
- 1972 Torino  
(Stock # B80-73515-290) - 25 pieces  
**OEM # D2OZ-80905-65A kit . . . . 11.95**
- Extended kit with wheel well screws
- 1972 Torino  
(Stock # B80-73515-295) - 58 pieces  
**OEM # D2OZ-80905-65B kit . . . . 19.95**



## Speed Nuts

Small clip that snaps on the back of emblems, moldings etc.

- 1/8" stud size**  
(Stock # P90-74010) - package of 10  
**OEM # COAZ-99991-A pkg. . . . . 4.95**
- .100 stud size**  
(Stock # P90-74010-005) - package of 10  
**OEM # COAZ-99991-B pkg. . . . . 4.95**
- #6-32 screw**  
(Stock # P90-74010-015) - package of 10  
**OEM # COAZ-99991-D pkg. . . . . 4.95**
- 1/8" stud size**  
(Stock # P90-74010-020) - package of 10  
**OEM # COAZ-99991-E pkg. . . . . 4.95**
- 3/16" stud size**  
(Stock # P90-74010-025) - package of 10  
**OEM # COAZ-99991-F pkg. . . . . 4.95**
- #8-32 screw**  
(Stock # P90-74010-030) - package of 10  
**OEM # COAZ-99991-G pkg. . . . . 4.95**
- #8 tapping screw size**  
(Stock # P90-74010-035) - package of 10  
**OEM # COAZ-99991-H pkg. . . . . 4.95**
- #8 screw size**  
(Stock # P90-74010-040) - package of 10  
**OEM # COAZ-99991-I pkg. . . . . 4.95**
- 5/32" stud size**  
(Stock # P90-74010-045) - package of 10  
**OEM # COAZ-99991-J pkg. . . . . 4.95**
- #10-24 screw size**  
(Stock # P90-74010-050) - package of 10  
**OEM # COAZ-99991-K pkg. . . . . 4.95**
- #10 tapping screw**  
(Stock # P90-74010-055) - package of 10  
**OEM # COAZ-99991-L pkg. . . . . 4.95**
- #12 tapping screw**  
(Stock # P90-74010-060) - package of 10  
**OEM # COAZ-99991-M pkg. . . . . 4.95**
- 1/4" x 20 screw size**  
(Stock # P90-74010-065) - package of 10  
**OEM # COAZ-99991-N pkg. . . . . 4.95**
- 1/4" stud size**  
(Stock # P90-74010-075) - package of 10  
**OEM # COAZ-99991-P pkg. . . . . 4.95**
- 5/16" stud size**  
(Stock # P90-74010-080) - package of 10  
**OEM # COAZ-99991-Q pkg. . . . . 3.95**
- 3/8" stud size**  
(Stock # P90-74010-085) - package of 10  
**OEM # COAZ-99991-R pkg. . . . . 3.95**



## Spin Lock Body Bolts

These bolts are used on most fenders as well as other places over the car. They have a black plated finish.

- 1/4" x 20 x 5/8" long - coarse thread**  
(Stock # P90-74025) - package of 5  
**OEM # COAZ-99998-A pkg. . . . . 3.95**
- 5/16" - 18 x 3/4" long - coarse thread** Price Reduced!  
(Stock # P90-74025-005) - package of 5  
**OEM # COAZ-99998-C pkg. . . . . 3.95**
- 5/16" - 24 x 1" - long fine thread** Price Reduced!  
(Stock # P90-74025-010) - package of 5  
**OEM # COAZ-99998-D pkg. . . . . 3.95**
- 5/16" - 18 x 1" long coarse thread**  
(Stock # P90-74025-015) - package of 5  
**OEM # COAZ-99998-E pkg. . . . . 3.95**
- 5/16" - 24 x 1 1/4" long, fine thread**  
(Stock # P90-74025-030) - package of 5  
**OEM # COAZ-99998-H pkg. . . . . 3.95**



## Fender Washers

- 1/2" diameter for 3/16" bolt**  
(Stock # P90-74020) - package of 10  
**OEM # COAZ-99997-A pkg. . . . . .95**
- 5/8" diameter for 1/4" bolt**  
(Stock # P90-74020-005) - package of 10  
**OEM # COAZ-99997-B pkg. . . . . .95**
- 3/4" diameter for 3/16" bolt**  
(Stock # P90-74020-010) - package of 10  
**OEM # COAZ-99997-C pkg. . . . . .95**
- 1 1/4" diameter for 1/4" bolt**  
(Stock # P90-74020-015) - package of 10  
**OEM # COAZ-99997-D pkg. . . . . 3.95**
- 1 1/2" diameter for 5/16" bolt**  
(Stock # P90-74020-020) - package of 10  
**OEM # COAZ-99997-E pkg. . . . . 3.95**
- 1 1/4" diameter for 3/16" bolt**  
(Stock # P90-74020-025) - package of 10  
**OEM # COAZ-99997-F pkg. . . . . 3.95**
- 1 1/2" diameter for 3/8" bolt**  
(Stock # P90-74020-030) - package of 10  
**OEM # COAZ-99997-G pkg. . . . . 3.95**
- 1 3/4" diameter for 3/8" bolt**  
(Stock # P90-74020-035) - package of 10  
**OEM # COAZ-99997-H pkg. . . . . 3.95**

# 1962-72 Fairlane



CAR COVERS

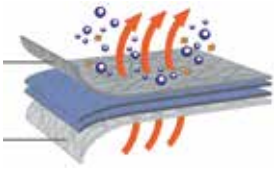

**Extra Logo**



### Technalon Car Cover

These covers are made of technalon. It is simply nothing but the best! These are the most rain resistant "breathable" car covers on the market. They are made from a triple fabric. They are a high-tech three layer fabric, lightweight and pliable in all weather conditions. They don't smell, rot or mildew. The outside and inside cover are made of long fibers which make the fabric very tough but very soft and non-abrasive. The middle layer is made of shorter fibers that catch water but still allow air to circulate. These covers have double stitched seams and neoprene elastic sewn into the hems at the front and rear for a snug, perfect, custom fit! They come equipped with non-scratch plastic grommets reinforced into the lower sides which will accommodate the tie down rope which is also included with the covers. This is a inexpensive investment for a valuable paint job! Specify blue, gray or tan.

1964-67 Fairlane

1966-67 Comet

(Stock # Z90-74030-325)

**OEM # CC-99999-C80 each . . . . . 225.00**

1966-67 Ranchero

(Stock # Z90-74030-130)

**OEM # CC-99999-C1111 each . . . . . 371.95**

1968-70 Fairlane & Montego

(Stock # Z90-74030-295)

**OEM # CC-99999-C68 each . . . . . 225.00**

1968-69 Ranchero

(Stock # Z90-74030-275)

**OEM # CC-99999-C471 each . . . . . 309.95**

1968-72 Torino

(Stock # Z90-74030-310)

**OEM # CC-99999-C726 each . . . . . 378.95**

1970-72 Ranchero

(Stock # Z90-74030-310)

**OEM # CC-99999-C726 each . . . . . 378.95**

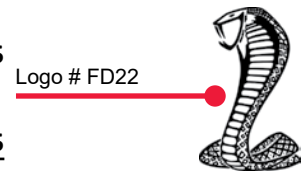

### Screen Printed Logo

Additional Screen printed Logos are available on the front of the car cover (see photo). Logos are \$25 and are screen printed in BLACK only. This is completed at the time your car cover is ordered. Order the FD # above that corresponds with the logo you want on the front of your cover.

**SPECIAL ORDER ITEMS ARE NON RETURNABLE! Please allow 10-14 days for delivery.**

# Ordering Information

## To Order By Mail

We accept personal checks, cashier's checks, and money orders, as well as Discover, Visa, MasterCard, and American Express credit and debit cards on any mail order. Generally we will ship your order to you no later than 48 hours from the time your payment has cleared. Please note that personal checks and some cashier's checks may take up to 10 working days to clear. If we are out of stock on any item we can, at your option, place that item on a back-order status and as soon as we receive the item in our warehouse we will promptly ship it to you. If the back-order should extend beyond thirty (30) days, we will notify you, and you may request to keep the part on back-order, or cancel the order.

## To Order By Phone

If you have your order ready including part numbers and quantities, simply call our toll free order desk at 1-800-654-3247 and one of our friendly, English-speaking operators will be happy to assist you. We accept Discover, Visa, MasterCard, and American Express credit and debit cards for telephone orders. If you have questions or need more information about a particular part or it's application, please call our parts department desk at (405) 631-3933 and one of our professional parts team members will be happy to assist you and answer any questions you may have.

## To Order Online

Ordering is easy online. Just go to our website at [www.CLASSICAUTOPARTS.COM](http://www.CLASSICAUTOPARTS.COM). We accept Discover, Visa, MasterCard, and American Express credit and debit cards for online ordering. If you have any problems ordering online or have a question about a particular part or it's application, give us a call and we will be glad to assist you in any way we can.

## Shipping Charges

Usually, your order will be shipped out no later than 48 hours after payment has cleared. Our primary shipping carrier is Federal Express, which allows us to keep shipping charges as low as possible. All Orders that are shipped via Federal Express ground within the continental United States will have the cost of shipping added to the order based on the shipping chart shown below. If you prefer that your order be shipped by another shipping company, you may request such when placing your order and we will quote you shipping charges at that time. **Oversized items that cannot be shipped using standard ground shipping will be shipped motor freight, and will incur additional shipping charges.** Please inquire when placing your order about additional shipping fees. Orders shipped to Alaska, Hawaii, or Puerto Rico will also incur additional shipping charges.

## Air Shipping

Next Day Air, Second Day Air, and Third Day Select Shipping is available on most items. You may request one of these shipping options when you place your order and we will quote you shipping charges at that time.

## Returns & Refunds

We accept returns on most items for thirty (30) days from the date of your invoice and will issue a refund for the purchase price less shipping charges as long as the items returned are still new in the original box. Items that have been installed, painted, scratched, or bear any sign of use cannot be returned. If you receive a defective part or we make a mistake on your order, notify us as soon as possible and we will expedite an exchange and cover all shipping costs to do so. All returns require a Return Authorization number (RA#), a copy of your invoice and a letter explaining why you are returning the item. The RA# should be written on the outside of the box. **We will not accept for return any items returned without an RA#.** All pre-approved items for return may be subject to a 20% restocking fee. All returned items must have shipping pre-paid. We will not accept C.O.D. returns. **Certain items cannot be returned such as books, catalogs, electrical parts, wood parts, special order parts or custom made items.** Please call us at 1-800-654-3247 to get an RA#.

## Damaged Items And/Or Shortages

You should inspect your order as soon as possible upon arrival. If you receive items that have been damaged in shipping the carrier should be notified immediately. If items are delivered via Motor Freight, please count all cartons before signing for the delivery and note any discrepancies on the bill of lading with your signature. **DO NOT RETURN DAMAGED ITEMS TO US!!** The carrier is responsible for all damages caused during shipping and will need to inspect the damaged items. Please call us if you have any questions concerning this. If you find a shortage or wrong item when your order arrives, please notify us within 72 hours of receipt of package. We are not responsible for wrong or missing items after 72 hours. We will do everything possible to make sure your claim is promptly taken care of.

## Refused or Undeliverable Shipments

Customer will be responsible for any shipping charges, storage fees, and handling fees associated with a refused or undeliverable shipment. A 20% restocking fee may also be charged.

## Pricing And Availability

All pricing and availability of items published in this catalog were accurate at the time of printing. However, due to production, supplier, and other market forces beyond our control, **prices do fluctuate from time to time as does the availability of certain items.** Please call us to confirm pricing and availability of any item or you can check out current and up to date pricing and inventory availability on our website at [www.CLASSICAUTOPARTS.COM](http://www.CLASSICAUTOPARTS.COM). Every effort has been made to insure that all information in this catalog is correct, however we are not responsible for typographical errors or misprints.

## Mailing List & Account Information

The first time you place an order with us we use the phone number you provide as your account number. We also maintain a record of purchases you make from us as well as your home and e-mail address information. We use this information to send you special sales fliers, new item updates, and other information that our customers tell us they find useful. If your address or phone number changes, or you do not wish to receive promotional notices from us, please contact us and we will update our records. We **do not** sell nor distribute any of this information to any outside source.

### Ground Shipping Charges - Continental U.S. - Excludes Hawaii, Alaska, and Puerto Rico

Orders Up To \$40.00 . . . . .	\$12.99	\$300.01 To \$500.00 . . . . .	9%
\$40.01 To \$150.00 . . . . .	\$14.99	\$500.01 To \$800.00 . . . . .	8%
\$150.01 To \$300.00 . . . . .	10%	Over \$800.00 . . . . .	7%

Shipments To Foreign Countries Please Add \$20.00 (Per Order) Handling Fee

**Obsolete &**  
**Classic Auto Parts, Inc.**  
 8701 South Interstate 35  
 Oklahoma City, Oklahoma 73149

# 2022 Swap Meet Schedule

LOCAL **405.631-3933** TOLL FREE **800.654.3247**

VISIT US ONLINE **WWW.CLASSICAUTOPARTS.COM**



Save money on shipping charges with free delivery to any of the swap meets listed below! Simply place your order online at **WWW.CLASSICAUTOPARTS.COM** or order by phone at **1-800-654-3247**, and we will deliver your order to the swap meet.

Simply pick up your pre-paid order when you get there, no hassles and no worries!

<b>Decatur Swap Meet</b> Decatur, Texas - Wise County Auto Club	<b>February 25-27, 2022</b>
<b>Pate, Texas</b> Texas Motor Speedway	<b>April 28-30, 2022</b>
<b>Wichita, Kansas</b> Kansas Sunflower Swap Meet	<b>March 11-12, 2022</b>
<b>Pigeon Forge, Tennessee</b> Grand National F-100 Show	<b>May 12-14, 2022</b>
<b>Springfield, Missouri</b> Ozark Empire Fair	<b>May 20-21, 2022</b>
<b>Traders Village</b> Grand Prairie, Texas	<b>September 13-14, 2022</b>
<b>Carlisle, Pennsylvania</b>	<b>September 30 - October 4, 2022</b>
<b>Hershey, Pennsylvania</b>	<b>October 7-10, 2022</b>

Dates shown on this schedule are tentative at the time of publication of this catalog, however, they are subject to change. Please call us, or check our website periodically for up to date information regarding swap meet times and dates.

*Serving the community since 1974!*

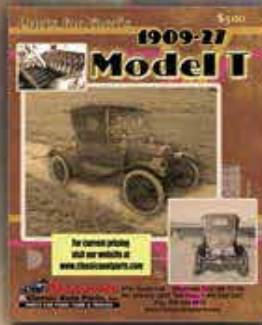

1909-27 Model T



1928-31 Model A



1932-48 Car & Pickup

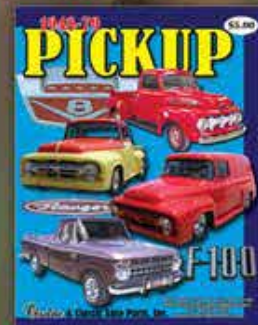

1948-79 Pickup & Bronco



1949-72 Fullsize



1955-66 T-Bird



1960-70 Falcon



1962-72 Fairlane/Torino

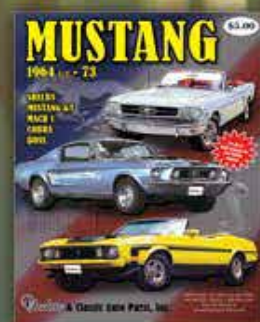

1964-73 Mustang



Any Catalog **FREE** with purchase!  
See Us Online

[www.classicautoparts.com](http://www.classicautoparts.com)